

DECORATIVE LIGHTING

karboxx

DECORATIVE
LIGHTING



Chi siamo/ about us

Fondata nel 2004, Karboxx produce lampade dal design raffinato e moderno, con materiali leggeri, resistenti e plasmati in forme uniche, eleganti, minimaliste. L'azienda pone la sua base nel nord-est Italia, nel più importante distretto industriale del mobile e della luce, che racchiude numerosi produttori e professionisti del settore.

Dal 2011 è parte di The Quadrifoglio Group, che vanta un'offerta completa per l'office living con un'ampia presenza distributiva internazionale grazie alla rete di retailer e distributori: questa unione ha consentito l'espansione di Karboxx sui mercati a livello mondiale e lo sviluppo della collezione Nyx, con tecnologie dedicate agli ambienti professionali e all'office-wellness.

La cura dei dettagli, il design esclusivo e l'attenzione ai materiali fanno di Karboxx un marchio dall'alto potenziale. Uno stile moderno e razionale contraddistingue le sue lampade, progettate per un inserimento semplice in ambienti adatti alla quotidianità della vita moderna. Karboxx si prende cura dei consumi e delle problematiche ambientali, proponendo ogni creazione a fonte LED e a risparmio energetico.

Founded in 2004, Karboxx manufactures lamps with refined and modern designs, with lightweight, resistant and molded materials in unique, elegant and minimalist shapes. The company has set its base in Northeast Italy, in the most important furniture and lighting industrial district, which includes many manufacturers and professionals in the industry. Since 2011, Karboxx is part of The Quadrifoglio Group, which offers a full range of office living furniture solutions with a large international distribution presence by its retail and distributor network. This partnership has allowed Karboxx to expand in the global markets and has led to the development of the Nyx collection, with technologies dedicated to professional environments and to office-wellness. The care for details and the attention to the materials that are used combined with exclusive design make karboxx one of the upscale brands of the greatest potential. Karboxx pays attention to modern life needs; the firm studies its projects in order to offer final users advantages. Karboxx take care of consumption and environmental issues. Most of lamps are available with energy saving bulbs and/or LED sources.



KELMAX

vetlo inak...

Rastislav Sabo - KELMAX

Košovská cesta 24
971 01 Prievidza

e-mail: kelmax@kelmax.sk

www.kelmax.sk

tel.: +421 944 919 288

ENRICO FRANZOLINI



Nato a Udine nel 1952 studia a Firenze e Venezia dove si laurea in Architettura. Nel 1972 fu invitato a partecipare alla 36ª Biennale di Venezia esponendo oggetti in vetro di Murano prodotti dal laboratorio di Livio Seguso. Nel 1978 la sua prima personale alla Galleria Plurima di Udine, inizio di un lavoro di ricerca nell'architettura minimale continuando il suo impegno nel disegno industriale.

Born in Udine in 1952. He studied in Florence and graduated in architecture at the University of Venice. In 1972 he was invited to the 36th Biennale Exhibition of decorative arts in Venice, exhibiting two objects produced by the Livio Seguso glass-manufactory in Murano. In 1978 his first personal exhibition at Plurima Gallery in Udine marked the beginning of his interest in minimal architecture. At the same time however he became interested in architecture and interior and product design.

SERENA PAPAÏT



Serena Papait, nasce a Portogruaro (Venezia) nel 1985. Si diploma nel 2007 in Disegno Industriale all'Università di Venezia ed inizia fin da subito a collaborare con numerose aziende e professionisti. Forte è la passione per l'arte e la fotografia come l'amore per la luce e le sue forme.

Serena Papait was born in Portogruaro (Venice) in 1985, where she achieved the teacher-training diploma and began to grow her art passion, taking part in some collective exhibition of the territory. She enrolled in the course of Industrial Design at the University Institute of Architecture in Venice IUAV dove si diploma nel 2007.

VICENTE GARCÍA JIMENEZ



Nato a Valencia (Spagna) nel 1978. Diplomato in Ingegneria Tecnica in Disegno Industriale all'Univeristà Castellon de la Plana trasferendosi poi a Barcellona. Parallelamente sviluppa i suoi interessi nell'ambito del design realizzando e sperimentando prototipi. Si trasferisce a Udine dove apre il suo studio che sviluppa prodotti di illuminazione, mobili ed allestimenti collaborando con numerose aziende.

Vicente was born in Valencia (Spain) in 1978. He graduated at the Faculty of Experimental Sciences in Castellon de la Plana. Later he moved to Barcelona. There he developed lighting and interior furniture designs. At this time he developed an interest with the environmental aspect of designing these items, constructing his first prototypes in this field. He moved towards Udine and he set up his Studio, that collaborates with a lot of companies, developing lighting products, furniture and exhibitions' settings.

FABIO FLORA



Cerca oggetti che rappresentano le forme archetipali, funzionali e costruttive. Cerca di conoscere la genesi. Analizza i modelli simbolici ed i valori di progettazione composti da semplici elementi geometrici.

He Looks for objects that represent archetype forms, functional and constructive. He tries to know the genesis. He analyses the symbolic values designing models made up from simple geometrical elements.

DAVID DOLCINI



"Credo che l'anima di ciò che chiamiamo design risieda nel costante rapporto tra complessità e semplicità, tra ciò che è visibile e ciò che è celato. Da sempre ho subito il fascino degli oggetti che incarnano questo delicato e raffinato gioco di equilibri. In ogni mio prodotto cerco di ricreare questa magia". Nato in Italia, nei pressi di Milano. La sua visione e il suo approccio al progetto provengono dalla mescolanza di molteplici esperienze educative e di lavoro all'estero nel corso degli anni.

"My work aim to investigate the relationship between complexity and simplicity, in search of that magic that only the delicate play of balances between these two elements can recreate". David was born in Italy, near Milan. His vision and approach to design comes from a whole variety of educational and professional experiences abroad over a number of years.

THOMAS FEICHTNER



Il lavoro di Thomas Feichtner si concentra sugli aspetti artistici e della sperimentazione. Cercando una modalità progettuale che non rispetta il dogma tradizionale e che va oltre la globalizzazione e la produzione di massa. Il suo lavoro coniuga sia l'aspetto artistico oltre alla sperimentazione. I suoi lavori sono presenti nelle più importanti collezioni nel mondo. È professore alla Muthesius Academy of Fine Arts and Design ed ha ricevuto il riconoscimento dalla Austrian State Award for Design nell'anno 2011. Abita e vive a Vienna.

Thomas Feichtner work is focused on artistic aspects and a more experimental approach. In search of an independent mode of operation that went beyond globalization and mass production. His works have been acquired by the most important design collections all over the world. Feichtner is a professor for product design at the Muthesius Academy of Fine Arts and Design and was awarded by the Austrian State Award for Design 2011. He lives and works in Vienna.

BRIAN RASMUSSEN



Nato a Ringsted (Danimarca) nel 1973. Si laurea alla Royal Accademy di Architettura a Copenhagen nel 2000. Il suo progetto futuristico per una stazione metro, vince il premio "PRISOPGAVE KØBENHAVN" (Danimarca). Dopo gli studi si trasferisce a Venezia, aprendo il suo studio di architettura e design. Nel 2004, vince il premio internazionale, Targetti Light Art Ward, che segna l'inizio della sua carriera quale light designer.

Brian was born in Ringsted (Denmark) in 1973. He graduates at The Royal Academy of Architecture in Copenhagen in 2000. All ready as a first year student his wins the national student competition " PRISOPGAVE KØBENHAVN" (Denmark) with a project for a futuristic metro station. After his studies he moved to Venice, opening his own office of architecture and design. In 2004 he wins the international art competition Targetti Light Art Ward which becomes a starting point for his career as lighting designer.

MARTA LAUDANI, MARCO ROMANELLI



Marta Laudani e Marco Romanelli, architetti, collaborano dal 1988 negli studi associati di Roma e Milano. Operativi nei campi del design, dell'architettura degli interni, dell'exhibit design (si ricorda, nel 2002-2003 l'antologica "Gio Ponti: a World" al Design Museum di Londra e alla Triennale di Milano; nel 2007 "Bruno Munari" al Tokyo Shiodome Italia). Il lavoro di progettazione si è sempre affiancato per entrambi ad un'intensa riflessione critica sui temi dell'abitare e del design: Marta Laudani ha insegnato "Architettura degli interni" e "Storia del design contemporaneo" alla facoltà di Architettura della Sapienza di Roma.

Marta Laudani and Marco Romanelli, architects, have been collaborating since 1988 in the associated offices of Rome and Milan. They work in the fields of design, interior decorating and exhibit design (in 2002-2003 "Gio Ponti: a World" at the London Design Museum, Rotterdam Nal and Triennial of Milan; in 2007 "Bruno Munari" in Tokyo). Both flank their design work with an intense critical meditation on topics involving living and design: Marta Laudani has lectured at the Sapienza in Rome. Lighting products, furniture and exhibitions' settings.

MASSIMILIANO MORNATI



Como 1970, si laurea in architettura a Milano nel 1998, dopo esperienze in studi di architettura a Rotterdam, Berlino e Milano inizia la sua attività di progettista nei campi dell'architettura, dell'allestimento e del disegno del prodotto continuando il suo impegno nel disegno industriale.

Como 1970, graduated in Architecture in Milan 1998, after gaining experience in architects' studios in Rotterdam, Berlin and Milan he began his activity as an industrial designer.

MORENO DE GIORGIO



Dopo la Laurea in Architettura a Venezia apre lo studio nel 2006 e si concentra sugli aspetti peculiari del disegno per l'industria. Alterna attività di ricerca a fare "artigiano", forte radicamento al territorio di appartenenza a tematiche di respiro globale, come sostenibilità, efficienza, paesaggio. Con la rivoluzione Led si appassiona al lighting e a illuminare in maniera efficace e confortevole residenza, luoghi di lavoro, spazi per il commercio, spazi espositivi, che considera veri e propri "habitat" per le persone.

After he graduated in Architecture in Venice he opened his own studio in 2006, directly involved as external consultant in a number of corporate teams. With the Led revolution, he focuses on lighting for workspaces the he considers as real "habitat" for the people.

ALESSIO PRINCIC E ROBERTO RIGHI



Alessio Princic si laurea in architettura nel 1982 a Ljubljana e nel 1985 a Venezia. Dal 1996 è assistente e poi professore all'università di Ljubljana, nel 2011 diventa professore associato e detiene due cattedre presso la facoltà di architettura di Maribor. Nel 1993 è tra i 40 giovani architetti italiani under 40 e molti sono i riconoscimenti ottenuti tra i quali l'European Steel Design Award in Lussemburgo, nel 2009 e nel 2012 la medaglia per l'architettura Plecnik in Slovenia e nel 2010 il premio internazionale METRA. Roberto Righi, nato a Gorizia nel 1974, si laurea nel 2001 in ingegneria all'Università di Trieste. Da sempre affascinato dal mondo dell'architettura e del disegno collabora dal 2002 con l'arch. Alessio Princic a Udine con cui partecipa alla progettazione di architetture e di interni.

Alessio gets the degree in Architecture in Ljubljana in 1982 and then in Venice in 1985. Since 1996, he has been Teaching Assistant, then Professor at the University in Ljubljana and in 2011 he became an Associated Professor holding two teaching posts at the University of Architecture in Maribor. In 1993, he was acknowledged amongst the 40 young talian architects under 40 and his accolades include the European Steel Design Award in Luxembourg, the Plecnik medal for Architecture in 2009 and 2012 and the international METRA award in 2010.

Born in Gorizia in 1974, Roberto Righi graduated in Engineering at the University of Trieste in 2001. Long fascinated by the world of Architecture and Design, in 2002 he began to collaborate with Architect Alessio Princic in Udine. Together they conceive architectural and interior design projects.

- 6. FABRIXX TECHNOLOGY
- 14. GRACE FLOOR
- 18. GRACE TABLE
- 22. GRACE PENDANT

ELIOS



- 102. ELIOS FLOOR

STARLIGHT

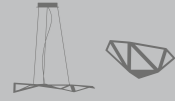

- 28. STARLIGHT PENDANT
- 28. STARLIGHT GIANT PENDANT
- 32. STARLIGHT WALL
- 32. STARLIGHT GIANT WALL

BALANCE



- 108. BALANCE TABLE

MIRAGE



- 40. MIRAGE PENDANT

BABEL



- 114. BABEL FLOOR
- 118. BABEL PENDANT

PIPES



- 46. PIPES PENDANT

AFRA

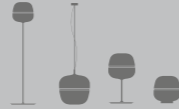

- 122. AFRA FLOOR
- 126. AFRA TABLE
- 128. AFRA PENDANT

OPPO



- 52. OPPO FLOOR

PEGGY



- 132. PEGGY TABLE
- 134. PEGGY FLOOR

HALFMOON

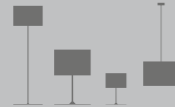

- 56. HALFMOON FLOOR
- 60. HALFMOON TABLE
- 62. HALFMOON MINI TABLE
- 66. HALFMOON PENDANT

BLONDE



- 140. BLONDE PENDANT

ZERO1



- 70. ZERO1 PENDANT
- 70. ZERO1 MINI PENDANT

WARM



- 146. WARM FLOOR
- 146. WARM OUTDOOR

OLA



- 74. OLA FLOOR
- 78. OLA MOVE FLOOR
- 82. OLA TABLE
- 86. OLA PENDANT
- 90. OLA SLIM WALL/CEILING
- 94. OLA FLY PENDANT

ESCAPE



- 152. ESCAPE PENDANT
- 156. ESCAPE WALL
- 158. ESCAPE WALL
- 162. ESCAPE CUBE WALL

TUPLA



- 168. TUPLA WALL

SUN

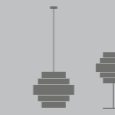

- 212. SUN PENDANT
- 216. SUN TABLE

SHINE



- 176. SHINE WALL

DRINK

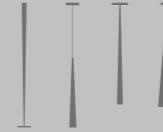

- 218. DRINK CEILING
- 226. DRINK BICONO CEILING
- 230. DRINK 63 PENDANT
- 234. DRINK FLOOR

TURN ME!



- 180. TURN ME! WALL

SLICE



- 238. SLICE PENDANT
- 242. SLICE CEILING
- 246. SLICE TABLE DESK
- 248. SLICE FLOOR

ALALUNGA



- 184. ALALUNGA WALL
- 184. ALALUNGA MINI WALL

TUBE



- 252. TUBE PENDANT
- 254. TUBE CEILING
- 256. TUBE WALL

SHADOW



- 190. SHADOW WALL

TUBE MICRO

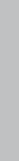

- 260. TUBE MICRO PENDANT

ADD



- 198. ADD PENDANT

SVEVA

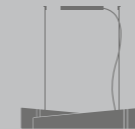

- 204. SVEVA PENDANT

GOUT



- 208. GOUT PENDANT

FABRIXX / TECHNOLOGY

Il tessuto si trasforma grazie ad un innovativo processo produttivo chiamato Fabrixx. Karboxx ha realizzato un nuovo concetto di paralume che unisce la tradizione e la bellezza estetica del tessuto alla praticità e durabilità dei materiali più resistenti. La tecnologia Fabrixx consente di fondere il tessuto come il lino naturale alla fibra di vetro, conservandone le caratteristiche estetiche tipiche come la trasparenza e la diffusione della luce, aggiungendo elementi quali indeformabilità, resistenza ai liquidi, facilità di pulizia ed assenza di qualsiasi manutenzione per una durata nel tempo infinita.

Fabric is transformed through an innovative productive process called Fabrixx. Karboxx has created a new concept of lampshade that combines the tradition and aesthetic beauty of fabric with the practicality and durability of more resistant materials. Fabrixx technology combines fabric like natural linen with fibreglass, preserving its typical, essential features like transparency and the diffusion of light and adding non-deformability, resistance to liquids, ease of cleaning and the absence of any need for maintenance for an infinite period of time.



GRACE /

Designed by Moreno De Giorgio

A volte il risultato di un design rigoroso e poetico nasce dal piacere quotidiano di ripensare le parti di un oggetto familiare e ben radicato nella memoria collettiva, per anticipare nuove necessità e tendenze, in un abile e mai scontato equilibrio tra innovazione tecnologica e semplice eleganza formale. Grace parte da una completa rilettura della tradizionale lampada con paralume, attraverso l'essenzialità del disegno unita alla praticità delle finiture, come la scelta del materiale del diffusore tessile, in lino con fibra di vetro e strutturalmente autoportante, grazie alla tecnologia Fabrixx sviluppata da Karboxx. Lo stelo verticale, non più ortogonale alla base, è caratterizzato da un gambo delicato e organico, al cui interno scorre il filo di alimentazione, che si stacca da una preziosa e leggera base ad anello, per crescere spontaneamente all'insù, verso il paralume contenente la luce, sospesa a mezz'aria. Scelta ardita, inusuale e carica di inventiva, fonte di nuove, inedite e gradevoli atmosfere.

Sometimes rigorous, poetic design is the result of a daily pleasure of redesigning the parts of a familiar object that is well-rooted in collective memory, to anticipate new needs and trends, in a capable and never banal equilibrium between high tech innovation and simple formal elegance. Grace begins with a complete reinterpretation of a traditional lamp with a lampshade, through the essential nature of the design, combined with the practicality of the finishes, like the choice of material for the fabric diffuser (linen and fibreglass) which is structurally self-supporting, thanks to Fabrixx technology developed by Karboxx. The vertical stem, which is no longer perpendicular to the base, features a delicate, organic stalk that contains the wiring, which detaches from a fine, light ring-shaped base to move to grow spontaneously upwards, towards the lampshade containing the light, pendant in the air.

A courageous, unusual choice full of inventiveness, which is the source of delightful, and brand new concept's.







Lampada da terra con struttura in metallo verniciato colore scuro; paralume in lino naturale e fibra di vetro (tecnologia Fabrixx).

Floor lamp with metal structure painted in a dark colour; shade in natural linen and fibreglass (Fabrixx technology).

Grace / Terra / Floor

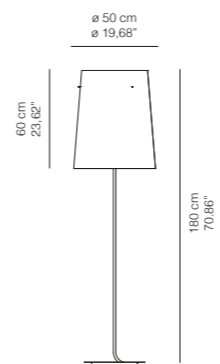

GRACE / Designed by Moreno De Giorgio

GRACE	Terra / Floor		SORGENTI LUMINOSE / LIGHT SOURCES		
MISURE / DIMENSIONS			FLUO	LED	
CM.	INCHES		3x33W E27	3x16W E27	
ZOTRIIFL	50Ø x 60-180H	19,68Ø x 23,62-70,86H	max 3x60W E27		
COLORI / COLOURS	Lino naturale e fibra di vetro - Tecnologia Fabrixx / Natural linen and fibreglass - Fabrixx Technology				CERTIFICATIONS
OPZIONI / OPTIONS					
DITR	Dimmer				

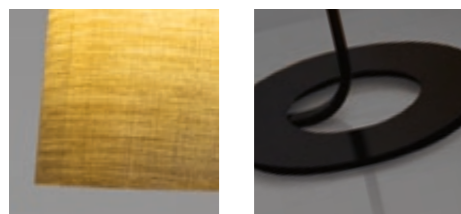



Lampada da tavolo, piccola o grande con struttura in metallo verniciato colore scuro; paralume in lino naturale e fibra di vetro (tecnologia Fabrixx).

Small or big table lamp with metal structure painted in a dark colour; shade in natural linen and fibreglass (Fabrixx technology).

Grace / Tavolo / Table

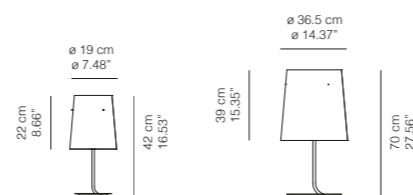

GRACE / Designed by Moreno De Giorgio

GRACE	Tavolo grande / Table grande		SORGENTI LUMINOSE / LIGHT SOURCES		CERTIFICATIONS
	MISURE / DIMENSIONS		FLUO		
	CM.	INCHES	LED		
20TV11FL	36,5ø x 39-70H	14,37ø x 15,35-27,56H	2x20W E27		
			2x10W E27		
			max 2x60W E27		
	COLORI / COLOURS				
	Lino naturale e fibra di vetro - Tecnologia Fabrixx / Natural linen and fibreglass - Fabrixx Technology				
GRACE	Tavolo piccola / Table piccola		SORGENTI LUMINOSE / LIGHT SOURCES		CERTIFICATIONS
	MISURE / DIMENSIONS		FLUO		
	CM.	INCHES	LED		
20TV12FL	19ø x 22-42H	7,48ø x 8,66-16,53H	1x20W E27		
			1x10W E27		
			max 1x40W E27		
	COLORI / COLOURS				
	Lino naturale e fibra di vetro - Tecnologia Fabrixx / Natural linen and fibreglass - Fabrixx Technology				
	OPZIONI / OPTIONS				
DITR	Dimmer				

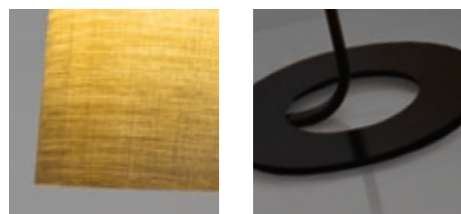



Lampada a sospensione con paralume in lino naturale e fibra di vetro (tecnologia Fabrixx) con diffusore inferiore in metacrilato opalino.

Pendant lamp with shade in natural linen and fibreglass (Fabrixx technology) and bottom diffuser in opaline methacrylate.

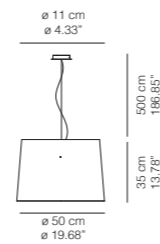

GRACE / Designed by Moreno De Giorgio

GRACE		Sospensione / Pendant		SORGENTI LUMINOSE / LIGHT SOURCES	
MISURE / DIMENSIONS		MISURE / DIMENSIONS		MISURE / DIMENSIONS	
CM.	INCHES	FLUO	LED		
20SP11FL	50ø x 35H	19,68ø x 13,78H	3x33W E27	3x16W E27	
			max 3x60W E27		
COLORI / COLOURS		COLORI / COLOURS		CERTIFICATIONS	
Lino naturale e fibra di vetro - Tecnologia Fabrixx / Natural linen and fibreglass - Fabrixx Technology		Lino naturale e fibra di vetro - Tecnologia Fabrixx / Natural linen and fibreglass - Fabrixx Technology			



Grace / Sospensione / Pendant

STARLIGHT /

Designed by Serena Papait

Starlight è una collezione di lampade dall'aspetto esile ma deciso, dove gli elementi geometrici vengono accostati creando un effetto dinamico.

La tecnologia utilizzata per l'illuminazione è il LED, disposto in modo tale da creare una luce indiretta e soft, ma al tempo stesso performante e diffusa. Questa collezione, nelle versioni da parete, sospensione e soffitto, può essere personalizzata nell'installazione a seconda degli spazi e dell'effetto che si vuole ottenere, dando vita anche a soluzioni più scenografiche accostandone diverse insieme.

Starlight is a collection of lamps with a slender, yet striking appearance, where geometric elements are combined to create a dynamic effect. LED technology is used for lighting, placed so as to create a soft, indirect light that is also high performance and diffused. This collection, with its wall, suspension and ceiling versions, can be customised for installation according to the spaces and the effect you want to create, also producing spectacular solutions by combing different versions.

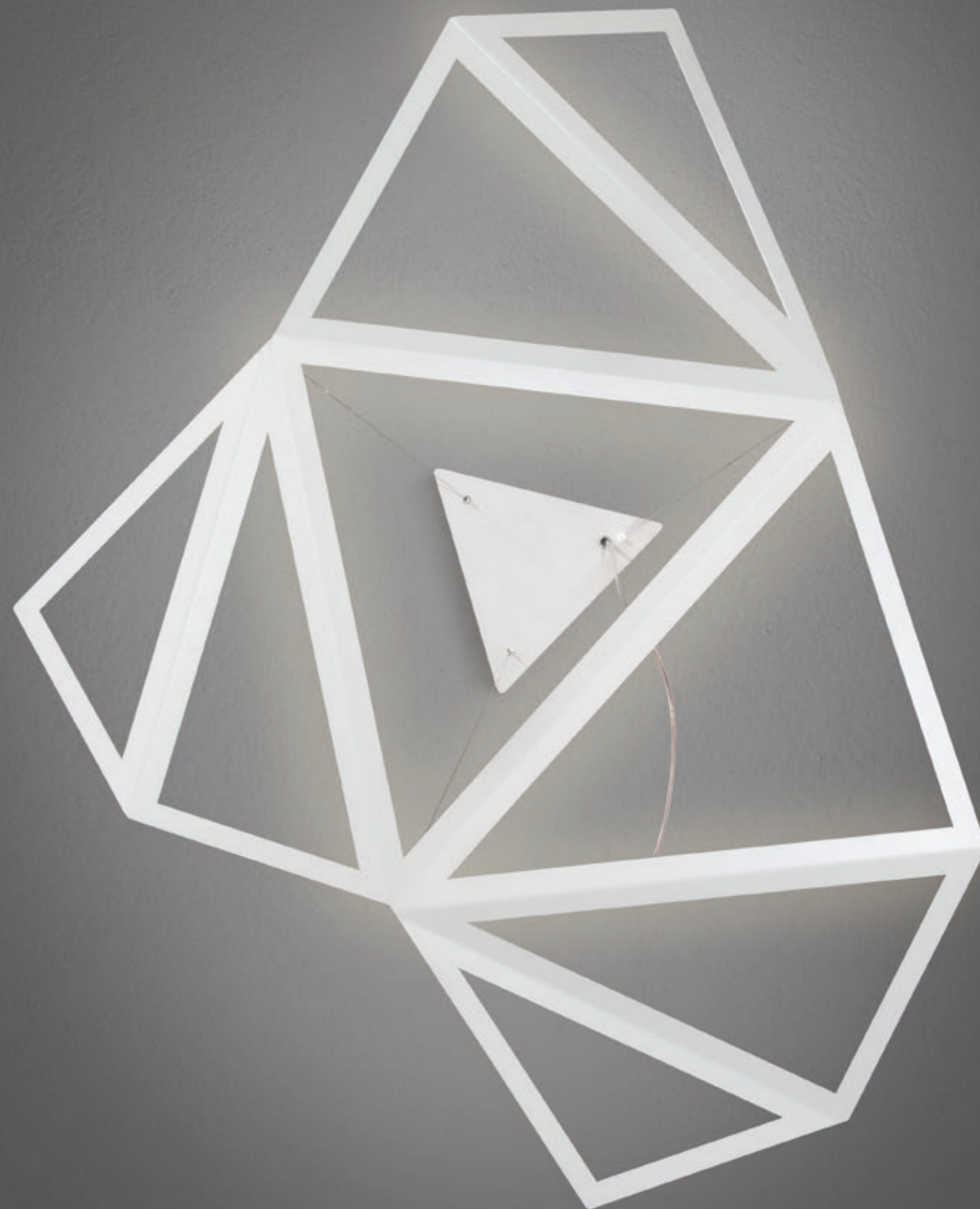



Lampada a sospensione in alluminio, verniciato bianco, antracite o oro. Illuminazione LED luce calda con diffusione indiretta e soft.

Pendant lamp in white, anthracite and gold painted aluminium. Warm indirect and diffuse reflection though LED light.

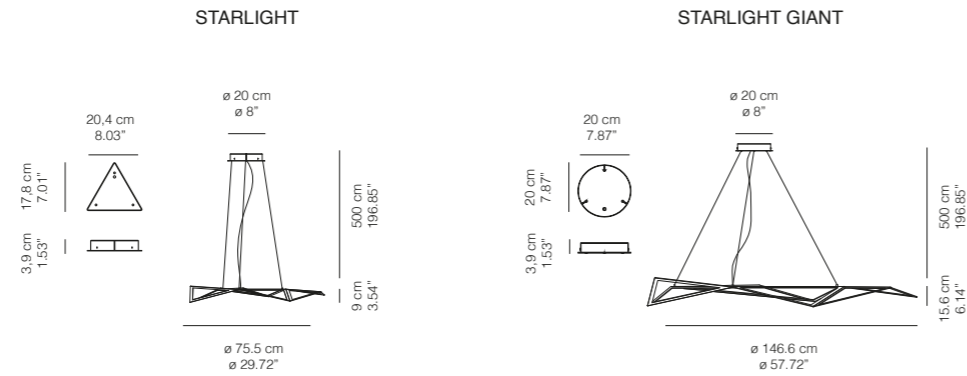

STARLIGHT / Designed by Serena Papait

Sospensione / Pendant		MISURE / DIMENSIONS		SORGENTI LUMINOSE / LIGHT SOURCES		Dimmer a taglio di fase AC phase-cut dimming	
CM	INCHES			LED			
STARLIGHT							
22SP01LW	75,5 x 57,5 x 9H	29,72 x 22,64 x 3,54H		39W - Lumen 2600 - 2700K	☐☐☐☐		
22SP01LG	75,5 x 57,5 x 9H	29,72 x 22,64 x 3,54H		39W - Lumen 2600 - 2700K	☐☐☐☐		
LED INCLUSO / LED INCLUDED							
STARLIGHT GIANT							
22SP02LW	102,5 x 146,6x 15,6H	40,35 x 57,72 x 6,14H		60W - Lumen 5400 - 2700K	☐☐☐☐		DALI-PUSH DIMM
22SP02LG	102,5 x 146,6x 15,6H	40,35 x 57,72 x 6,14H		60W - Lumen 5400 - 2700K	☐☐☐☐		DALI-PUSH DIMM
22SP02LL	102,5 x 146,6x 15,6H	40,35 x 57,72 x 6,14H		60W - Lumen 5400 - 2700K	☐☐☐☐		DALI-PUSH DIMM
LED INCLUSO / LED INCLUDED							
COLORI / COLOURS						CERTIFICATIONS	
22SP01LW	Alluminio verniciato Bianco / White painted aluminium						☐ ☑ CE IP 20
22SP01LG	Alluminio verniciato Antracite / Anthracite painted aluminium						
22SP02LW	Alluminio verniciato Bianco / White painted aluminium						
22SP02LG	Alluminio verniciato Antracite / Anthracite painted aluminium						
22SP02LL	Alluminio verniciato Oro / Gold painted aluminium						

LED

22SP01LW 22SP02LW 22SP01LG 22SP02LG 22SP02LL STARLIGHT STARLIGHT GIANT

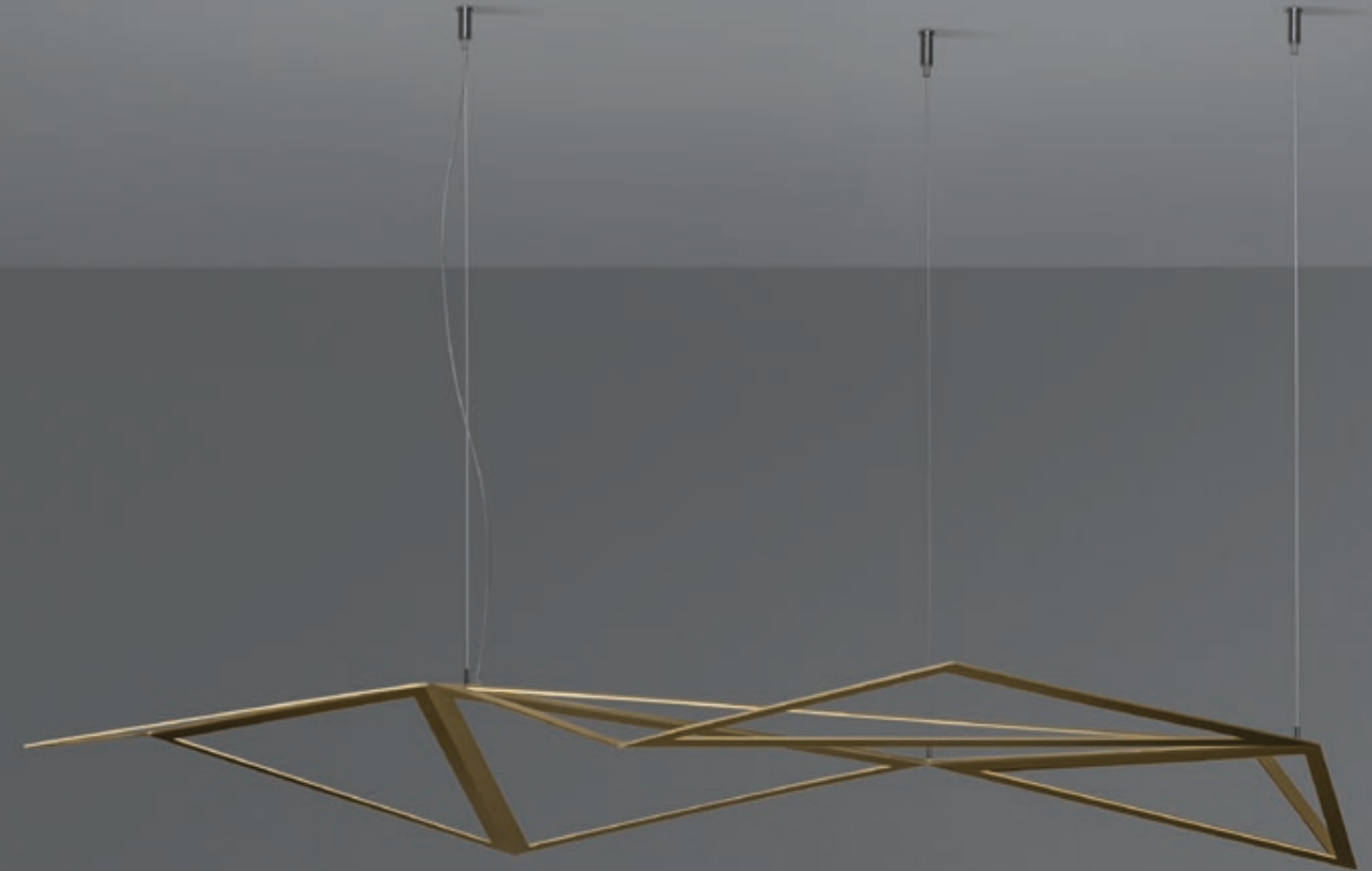
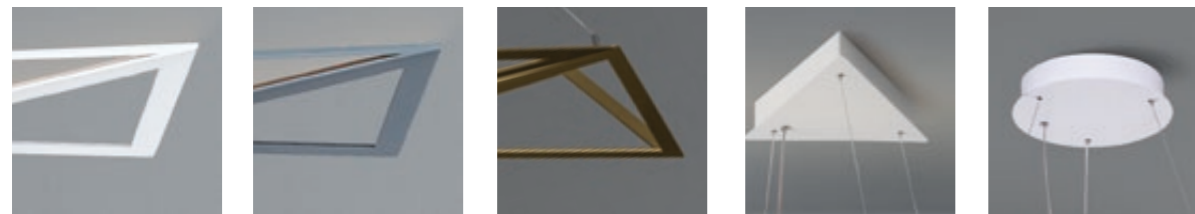

Starlight Giant / Sospensione / Pendant



Lampada da parete in alluminio, verniciato bianco, antracite o oro. Illuminazione LED luce calda con diffusione indiretta e soft.

Wall-mounted aluminium lamp, painted in white, anthracite and gold. Warm indirect and diffuse reflection though LED light.

Starlight / Parete / Wall-mounted

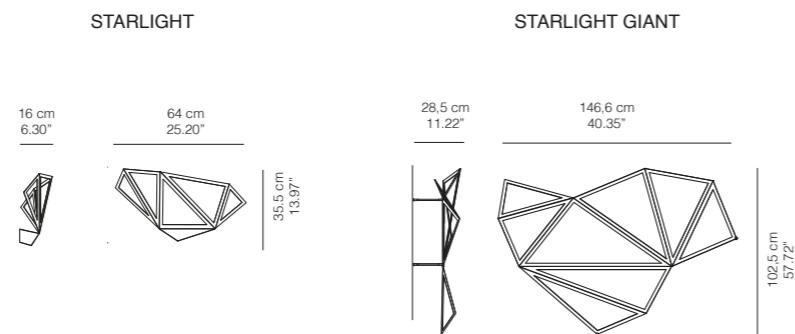

STARLIGHT / Designed by Serena Papait

	Parete / Wall		SORGENTI LUMINOSE / LIGHT SOURCES		
	MISURE / DIMENSIONS		LED		
	CM	INCHES			
STARLIGHT					
22PA01LW	64 x 35,5 x 16	25,2 x 13,97 x 6,3	19W - Lumen 2000 - 2700K <input type="checkbox"/>		
22PA01LG	64 x 35,5 x 16	25,2 x 13,97 x 6,3	19W - Lumen 2000 - 2700K <input type="checkbox"/>		
STARLIGHT GIANT					
22PA02LW	102,5 x 146,6 x 28,5	57,72 x 40,35 x 11,22	60W - Lumen 5400 - 2700K <input type="checkbox"/>		DALI-PUSH DIMM
22PA02LG	102,5 x 146,6 x 28,5	57,72 x 40,35 x 11,22	60W - Lumen 5400 - 2700K <input type="checkbox"/>		DALI-PUSH DIMM
22PA02LL	102,5 x 146,6 x 28,5	57,72 x 40,35 x 11,22	60W - Lumen 5400 - 2700K <input type="checkbox"/>		DALI-PUSH DIMM
COLORI / COLOURS					
22PA01LW	Alluminio verniciato Bianco / White painted aluminium				CERTIFICATIONS <input type="checkbox"/> <input type="checkbox"/> <input type="checkbox"/> <input type="checkbox"/> IP 20
22PA01LG	Alluminio verniciato Antracite / Anthracite painted aluminium				
22PA02LW	Alluminio verniciato Bianco / White painted aluminium				
22PA02LG	Alluminio verniciato Antracite / Anthracite painted aluminium				
22PA02LL	Alluminio verniciato Oro / Gold painted aluminium				

LED

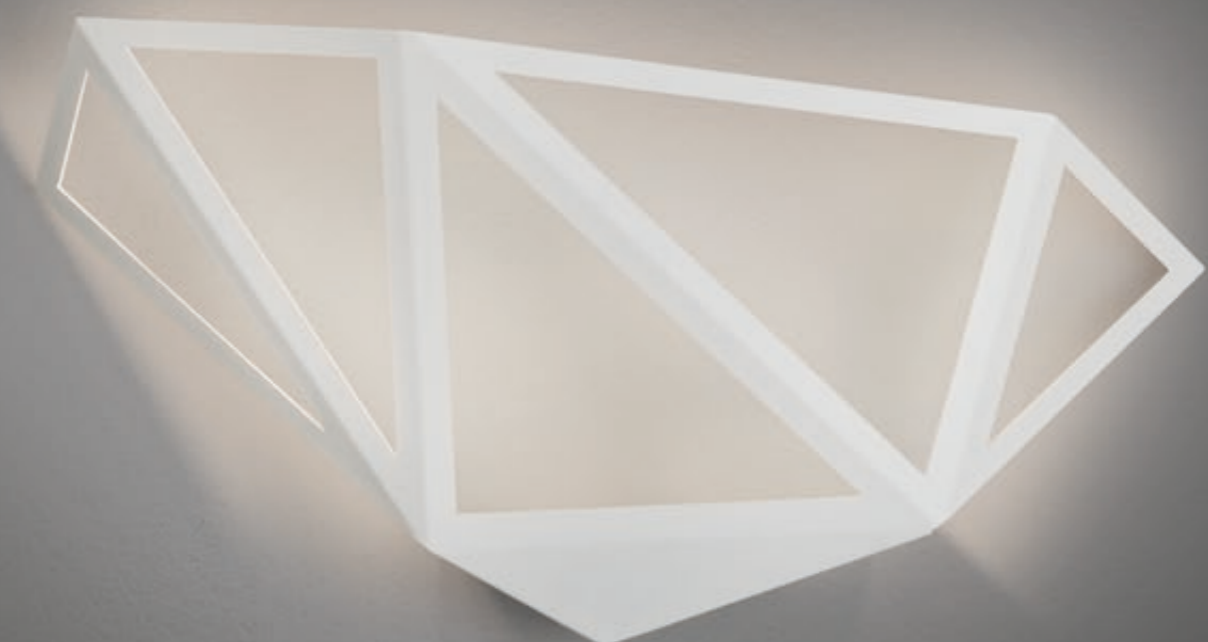
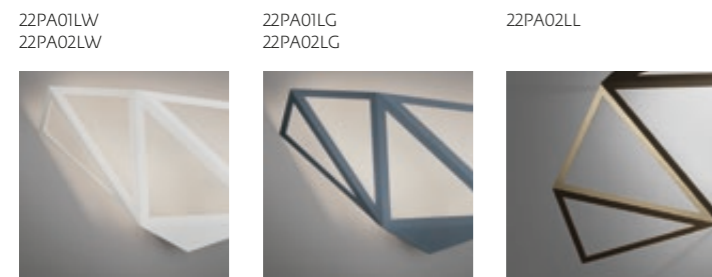

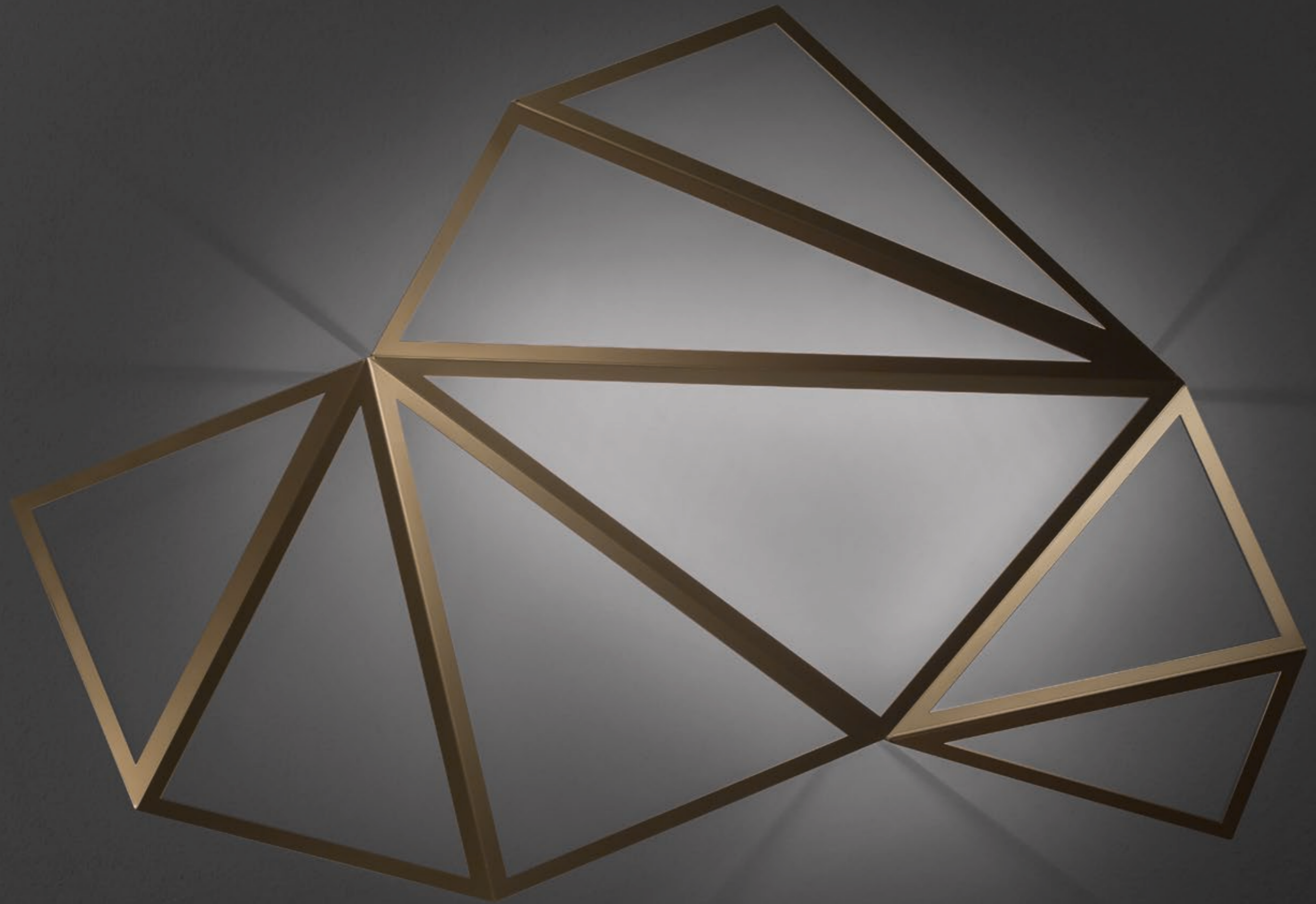

MIRAGE /

Designed by David Dolcini

“Volevo racchiudere un forte dinamismo all'interno di un oggetto atemporale, dalle proporzioni eleganti e dal profilo femminile”. Grazie al suo profilo sinuoso e alla relazione che si genera tra le due finiture, interna ed esterna, la percezione della luce e della lampada stessa muta di volta in volta a seconda della posizione di chi la osserva. Caratterizzata dall'utilizzo di una sorgente LED di ultima generazione e da un paralume in alluminio con una doppia finitura (esterna e interna), Mirage è una lampada pensata per arredare, decorare ambienti e spazi privati e progetti contract.

“I wanted to encapsulate strong dynamism inside a timeless object with elegant, feminine proportions”. Thanks to its sinuous outline and the relationship between the inner and outer finishes, the perception of the light and the lamp itself changes according to the position of the observer. It features a last generation LED bulb and an aluminium lampshade with a dual inner and outer finish. Mirage is a lamp designed to furnish, decorate homes, private spaces and contract projects.





Lampada a sospensione in metallo con finiture cromo, rame, ottone o bianco lucido. Rosone in tinta con il paralume.
Sorgente LED 220-240v luce calda.
Dimmerabile a taglio di fase.

Pendant metal lamp in chrome, copper, brass or shiny white finish. Ceiling rose in the same finish.
LED 220-240 warm light source.
AC phase-cut dimming.

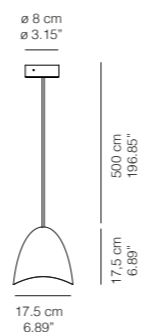

MIRAGE/ Designed by David Dolcini

MIRAGE	Sospensione / Pendant		SORGENTI LUMINOSE / LIGHT SOURCES		Dimmer a taglio di fase AC phase-cut dimming
	MISURE / DIMENSIONS		LED		
	CM	INCHES	8,7W - Lumen 800 - 2700K		
	17,5ø x 17,5	6,89 x 6,89	LED INCLUSO / LED INCLUDED		
	COLORI / COLOURS				CERTIFICATIONS
24SP01LC	Metallo finitura Cromato / Chrome finish metal				CE IP 20 CLASSE 1
24SP01LR	Metallo finitura Rame / Copper finish metal				
24SP01LT	Metallo finitura Ottone / Brass finish metal				
24SP01LW	Metallo verniciato Bianco lucido / Shiny White painted metal				

LED

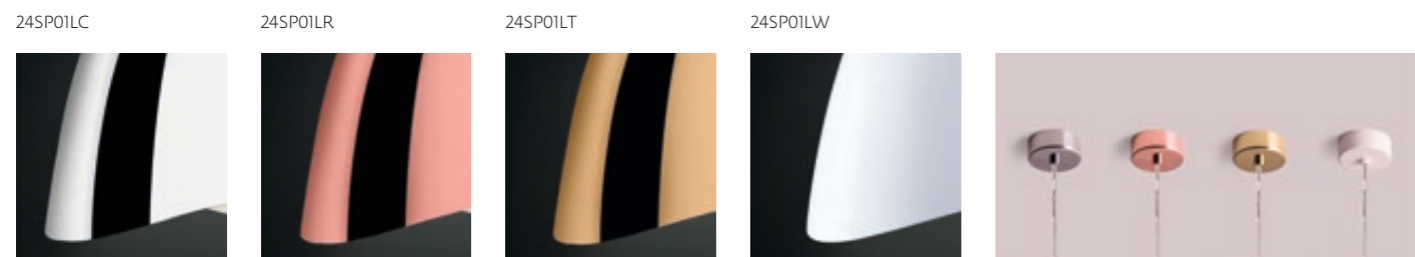

Mirage / Sospensione / Pendant

PIPES /

Designed by Thomas Feichtner

Tubi accavallati uno sopra l'altro a formare una cascata. Questo raffinato e semplice concetto è alla base della progettazione del designer austriaco Thomas Feichtner. Tubi in alluminio di diverse lunghezze, piegati ed accavallati con una leggera angolazione, a cui ad ogni estremità è stata posta una sorgente LED. I singoli segmenti dalle linee bidimensionali sono disposti a ventaglio a formare una circonferenza, ottenendo così un unico corpo, un oggetto geometrico e leggero.

Pipes one crossed over the other to form a cascade. This simple and elegant concept is the basis of projects by Austrian designer Thomas Feichtner. Aluminium pipes of various lengths bent and crossed at a slight angle, with an LED light source at every end. The individual segments with their two-dimensional lights are arranged in a fan-shape to form a circumference, producing a single body, a light, geometric object.





Lampada a sospensione composta da tubi in alluminio piegati e accavallati. Struttura verniciata in tre colori: bianco, antracite, oro. Sorgenti LED luce calda su ciascuna estremità.

Pendant lamp made by aluminium pipes bent and crossed one over the other. Structure painted in three colours: white, anthracite, gold. LED warm light source on each end.

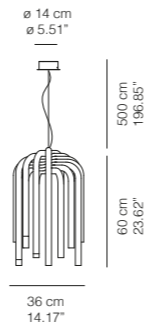

PIPES/

Designed by Thomas Feichtner

PIPES	Sospensione / Pendant		SORGENTI LUMINOSE / LIGHT SOURCES		CERTIFICATIONS
	MISURE / DIMENSIONS		LED		
	CM	INCHES	16x1W - Lumen 1400 - 2700K		☐ ▽ CE IP 20
	36ø x 60H	14,17ø x 23,62H	LED INCLUSO / LED INCLUDED		
COLORI / COLOURS					
23SP1IL2	Alluminio verniciato Bianco / Matt White painted aluminium				
23SP1IL1	Alluminio verniciato Antracite / Matt Anthracite painted aluminium				
23SP1IL3	Alluminio verniciato Oro lucido / Shiny Gold painted aluminium				

LED



23SP1IL2



23SP1IL1



23SP1IL3

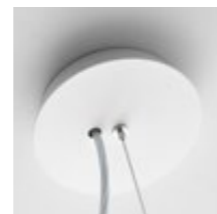
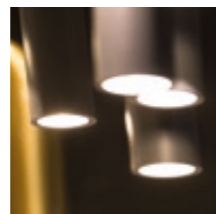

Pipes / Sospensione / Pendant

OPPO /

Designed by Thomas Feichtner

Fino ad oggi, molte lampade hanno richiesto paralumi o riflettori per diffondere e direzionare la luce. Non le lampade Oppo: grazie alla più recente tecnologia LED, la sorgente di luce funge anche da diffusore, offrendo una piacevole luce diretta ed indiretta. Si tratta di una superficie di illuminazione sottile appena 10 mm posta in cima ad una costruzione rettangolare. Da qui il nome Oppo per "opposite", "opposto", come un riferimento alla sua illuminazione bidirezionale. Il concetto di design puro e minimalista rende questa lampada speciale e funzionale anche nell'uso quotidiano, in quanto grazie alla mensola, diventa oggetto pratico e d'arredo, proposto in due diverse altezze: 175 e 120 cm.

Until today, many lamps have needed lampshades or reflectors to spread or direct light. Not Oppo lamps, thanks to the most recent LED technology. The light source also acts as a diffuser, offering both pleasant direct and indirect light. It has a thin light surface, just 10 mm, placed on the top of a rectangular body. This was the inspiration for its name: Oppo for 'opposite', as a reference to its bi-directional lighting. The pure, minimalist design concept makes this lamp special and functional, even in everyday use, as thanks to its shelf it becomes a practical furnishing item, available in two heights: 175 and 120 cm.





Lampada da terra composta da una composizione rettangolare in metallo verniciato antracite e un sottile diffusore in metacrilato HR per un'illuminazione bidirezionale (diretta e indiretta). Sorgente LED luce calda. Dimmerabile.

Floor lamp made by a rectangular structure in anthracite painted metal and a thin HR methacrylate diffuser that enables a bidirectional lighting (both direct and indirect). LED warm light source. Dimmable.

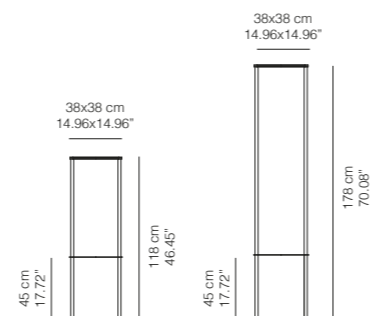

OPPO / Designed by Thomas Feichtner

OPPO	Terra / Floor		SORGENTI LUMINOSE / LIGHT SOURCES		with dimmer
	MISURE / DIMENSIONS				
	CM	INCHES	LED		
OPPO 120					
26TR11L1	38 x 38 x 118H	14,96 x 14,96 x 46,45H	33W - Lumen 3500 - 2700K ☼☼☼☼		
OPPO 175			LED INCLUSO / LED INCLUDED		
26TR12L1	38 x 38 x 178H	14,96 x 14,96 x 70,08H	33W - Lumen 3500 - 2700K ☼☼☼☼		
			LED INCLUSO / LED INCLUDED		
	COLORI / COLOURS		CERTIFICATIONS		
	Struttura in metallo verniciato Antracite / Anthracite painted metal structure		CE IP 20 CLASSE 1		
	Diffusore in HR metacrilato satinato / Satin HR methacrylate diffuser				

LED



HALF MOON /

Design Enrico Franzolini with Vicente Garcia Jimenez

Collezione composta da lampada da tavolo in due dimensioni, grande e mini, terra e sospensione. Paralume in fibra di carbonio con interno verniciato in più colori. Stelo in carbonio e base in alluminio verniciata nera.

A collection made up of a table lamp in two sizes, large and mini, and a floor and hanging version. Shade in carbon fibre with interior painted in several colours. Carbon stem and base in black-painted aluminium.



Lampada da terra con paralume in fibra di carbonio verniciato internamente in tre colorazioni diverse. Stelo in carbonio e base in alluminio verniciato nero.

Floor lamp with shade in carbon fibre with interior painted in three different colours. Stem in carbon and base in black-painted aluminium.

Half moon / Terra / Floor

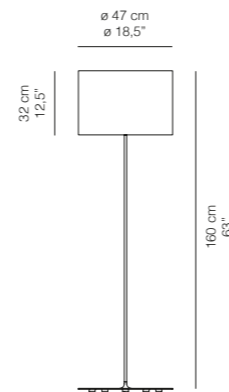

HALF MOON / Design Enrico Franzolini with Vicente Garcia Jimenez

HALF MOON	Terra / Floor		SORGENTI LUMINOSE / LIGHT SOURCES		CERTIFICATIONS
	MISURE / DIMENSIONS				
	CM.	INCHES	FLUO	LED	
	47ø x 32-160H	18,5ø x 12,5-63H	3x23W E27	3x16W E27	
	COLORI / COLOURS				
03TRI6001	Fibra di carbonio / Carbon fibre: Nero / Black - interno Avorio / Ivory inside				
03TRI6002	Fibra di carbonio / Carbon fibre: Nero / Black - interno Viola / Purple inside				
03TRI6003	Fibra di carbonio / Carbon fibre: Nero / Black - interno Arancio / Orange inside				
	Diffusore in metacrilato opalino incluso / Diffuser in opaline methacrylate included				
	OPZIONI / OPTIONS				
DITR	Dimmer				

03TRI6001



03TRI6002



03TRI6003





Lampada da tavolo con paralume in fibra di carbonio verniciato internamente in tre colorazioni diverse. Stelo in carbonio e base in alluminio verniciato nero.

Table lamp with shade in carbon fibre with interior painted in three different colours. Stem in carbon and base in black-painted aluminium.

Half moon / Tavolo / Table

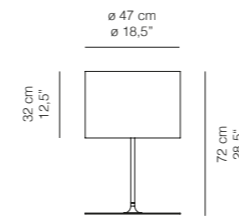

HALF MOON / Design Enrico Franzolini with Vicente Garcia Jimenez

HALF MOON	Tavolo / Table		SORGENTI LUMINOSE / LIGHT SOURCES		CERTIFICATIONS
	MISURE / DIMENSIONS		FLUO	LED	
	CM.	INCHES			
	47ø x 32-72H	18,5ø x 12,5-28,5H	3x23W E27	3x16W E27	
	COLORI / COLOURS				
03TV03201	Fibra di carbonio / Carbon fibre: Nero / Black - interno Avorio / Ivory inside				
03TV03202	Fibra di carbonio / Carbon fibre: Nero / Black - interno Viola / Purple inside				
03TV03203	Fibra di carbonio / Carbon fibre: Nero / Black - interno Arancio / Orange inside				
	Con diffusore in metacrilato opalino / with diffuser in opaline methacrylate				
	OPZIONI / OPTIONS				
DITV	Dimmer				



03TV03201

03TV03202

03TV03203



Lampada da tavolo con paralume in fibra di carbonio con interno e base verniciati in due colorazioni diverse. Base e stelo in metallo.

Table lamp with shade in carbon fibre with interior and base painted in two different colours. Base and stem in metal.

Half moon mini / Tavolo / Table

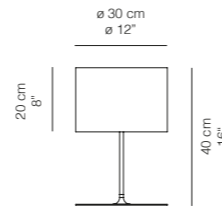

HALF MOON mini / Design Enrico Franzolini with Vicente Garcia Jimenez

HALF MOON mini	Tavolo / Table		SORGENTI LUMINOSE / LIGHT SOURCES	
	MISURE / DIMENSIONS			
	CM.	INCHES	HALOG.	
	30ø x 20-40H	12ø x 8-16H	E-saver max 1x42W G9	
	COLORI / COLOURS		CERTIFICATIONS	
03TVL005	Fibra di carbonio / Carbon fibre: Nero / Black - interno Arancio / Orange inside			
03TVL006	Fibra di carbonio / Carbon fibre: Nero / Black - interno Viola / Purple inside			
	OPZIONI / OPTIONS			
	E14 su richiesta / on demand			



03TVL006

03TVL005



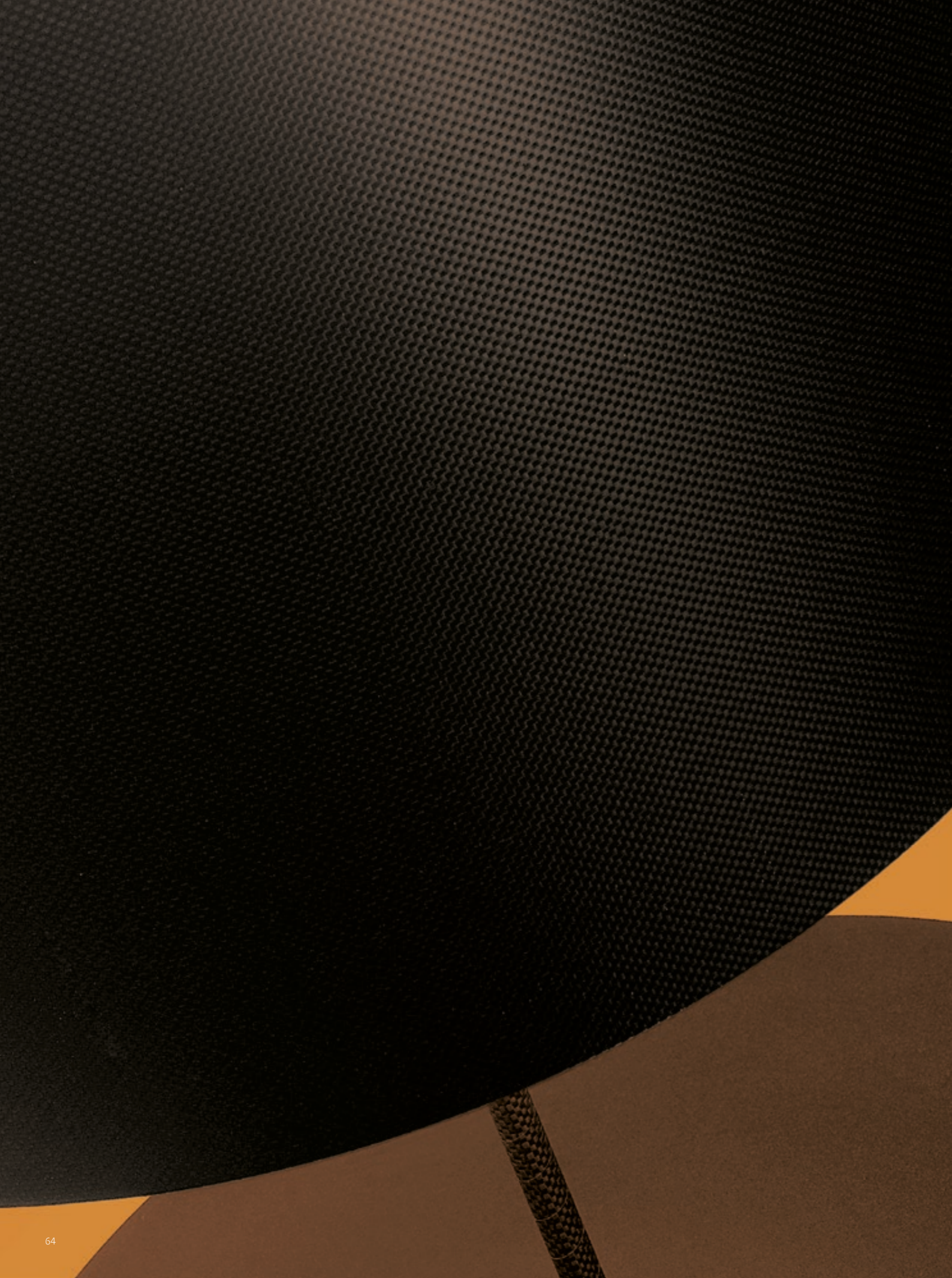

Lampada da sospensione con paralume in fibra di carbonio verniciato internamente in tre colorazioni diverse.

Pendant lamp with shade in carbon fibre with interior painted in three different colours.

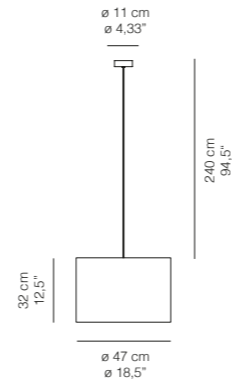

HALF MOON / Design Enrico Franzolini with Vicente Garcia Jimenez

HALF MOON	Sospensione / Pendant		SORGENTI LUMINOSE / LIGHT SOURCES		CERTIFICATIONS
	MISURE / DIMENSIONS		FLUO	LED	
	CM.	INCHES			
	47ø x 32-240H	18,5ø x 12,5-94,5H	3X23W E27	3X16W E27	
COLORI / COLOURS					
03SP03201	Fibra di carbonio / Carbon fibre: Nero / Black - interno Avorio / Ivory inside				
03SP03202	Fibra di carbonio / Carbon fibre: Nero / Black - interno Viola / Purple inside				
03SP03203	Fibra di carbonio / Carbon fibre: Nero / Black - interno Arancio / Orange inside				
	Con diffusore in metacrilato opalino / with diffuser in opaline methacrylate				
OPZIONI / OPTIONS					
5MT	Sospensione cablaggio lunghezza cavi mt. 5,00 / Suspended with longer cables mt. 5,00				



03SP03201



03SP03202



03SP03203



Half moon / Sospensione / Pendant

ZERO1 /

Design Princic&Righi

Zero1 è una forma pura pensata per stare in ogni spazio. Non nasce per essere "la novità", ma come evoluzione di un concetto che appartiene al nostro immaginario. Un anello di led che illumina un paralume traslucido in fibra di vetro rendendo la lampada riconoscibile e discreta allo stesso tempo. La personalizzazione delle dimensioni e le molte combinazioni possibili consentono di illuminare dagli ambienti classici fino agli spazi più estremi. Un oggetto aperto ad infinite interpretazioni.

Zero1 is a pure shape designed for any space. It has not been conceived as a "new idea", but as the evolution of a concept we have in our collective unconscious. An LED ring that lights up a translucent fibre glass lampshade, making the lamp instantly recognisable yet discreet. It can be personalised in size and is available in many combinations to bring light to the most traditional or unusual spaces. Zero1: an object which is open to infinite interpretations.



Lampada sospensione con paralume in fibra di vetro bianco. Disponibile in altri colori e dimensioni a richiesta. Anello LED a luce calda.

Pendant lamp with shade in white fiberglass: on request in different colors and sizes. LED ring with warm light.

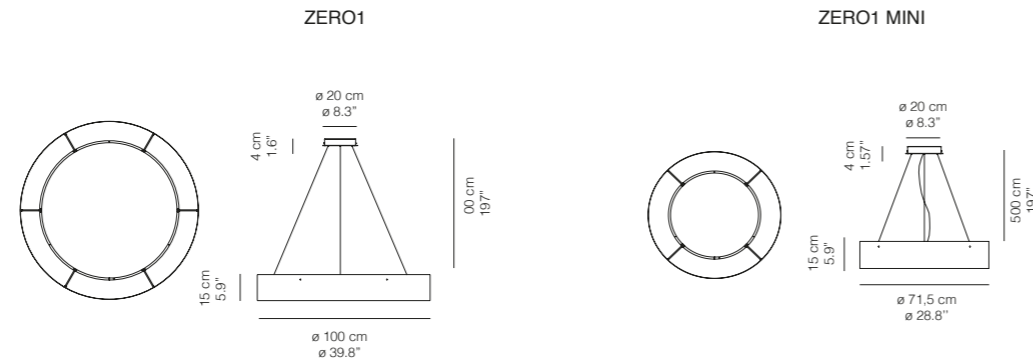

ZERO1 / Design Prinic&Righi

Sospensione / Pendant		SORGENTI LUMINOSE / LIGHT SOURCES	
MISURE / DIMENSIONS		LED	
CM.	INCHES		
ZERO1 28SP01L1	Ø100x100x15H Ø39.4x39.4x6.3H	50 W - LUCE CALDA 2700K - 5400 Lumen 110-230V DIMMERABILE DALI	50 W - WARM LIGHT 2700 K - 5400 Lumen 110-230V DIMMABLE DALI
ZERO1 mini 28SP02L1	Ø71.5x71.5x15H Ø28.8x28.8x9H	38 W - LUCE CALDA 2700K - 3750Lumen 110-230V DIMMABLE DALI	38 W - WARM LIGHT 2700K - 3750Lumen 110-230V DIMMABLE DALI
COLORI / COLOURS		CERTIFICATIONS	
Fibra di vetro Bianca / White Fibreglass		CE IP 20 CLASSE 1	

LED



Zero1 / Sospensione / Pendant

OLA /

Design Enrico Franzolini

Ola è la collezione nata dalle sensazioni del designer Enrico Franzolini: Karboxx le materializza attraverso nuove tecnologie e materiali. Una fibra di vetro che è risultato di un lungo processo di ricerca tecnologica e materica. Un materiale che crea atmosfere uniche filtrando la luce attraverso le sue forme. La luce chiara che illumina la notte, il sole cocente d'estate, la bellezza di un tramonto: Ola reinterpreta la luce degli elementi in tre misure e cinque finiture.

Terra, tavolo, appoggio, sospensione, soffitto e parete: una collezione completa che utilizza lampadine LED ed a risparmio energetico.

Ola is the collection born from the sensations of the designer Enrico Franzolini: Karboxx materialized these sensations through new materials and technologies. A composite Fibreglass is the result of a long process of R&D. Beautiful atmospheres, shadows and lights filtered by the shape of the lamp. The bright light in the night, a hot sun in the summer, the beauty of a sunset: Ola reinterprets the light of elements in three sizes and five colors. Floor, pendant, table: a complete range using LED and energy saving bulbs.



Ola, un nome semplice per una lampada semplice.
 La perfezione imperfetta, la materia immateriale, la notte e il giorno, il sole e la luna, la realtà e il sogno.
 Paralume in fibra di vetro in cinque differenti colori e stelo in metallo verniciato antracite.
 Disponibile in altri colori a richiesta.

Ola, It's a simple name for a simple light. The imperfect perfection, the immaterial material, the night and the day, the sun and the moon, the reality and the dream.
 The shade in fibreglass is available in five different colors.
 Base in anthracite painted metal.
 On request any color available.

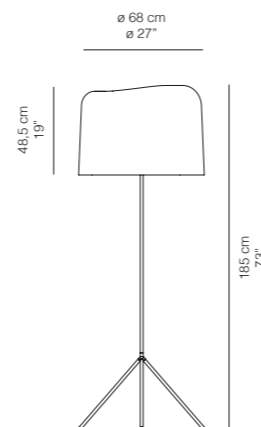

OLA / Design Enrico Franzolini

OLA	Terra / Floor		SORGENTI LUMINOSE / LIGHT SOURCES		CERTIFICATIONS
	MISURE / DIMENSIONS		FLUO	LED	CE IP 20
	CM.	INCHES	3x32W E27	3x16W E27	
	68ø x 48-185H	27ø x 19-73H			
	COLORI / COLOURS				
09TR68F2	Fibra di vetro Bianca / White Fibreglass				
09TR68F3	Fibra di vetro Rosso / Red Fibreglass				
09TR68F5	Fibra di vetro Arancio / Orange Fibreglass				
09TR68F6	Fibra di vetro Oro / Gold Fibreglass				
09TR68F7	Fibra di vetro Argento / Silver Fibreglass				
	OPZIONI / OPTIONS				
DITR	Dimmer				

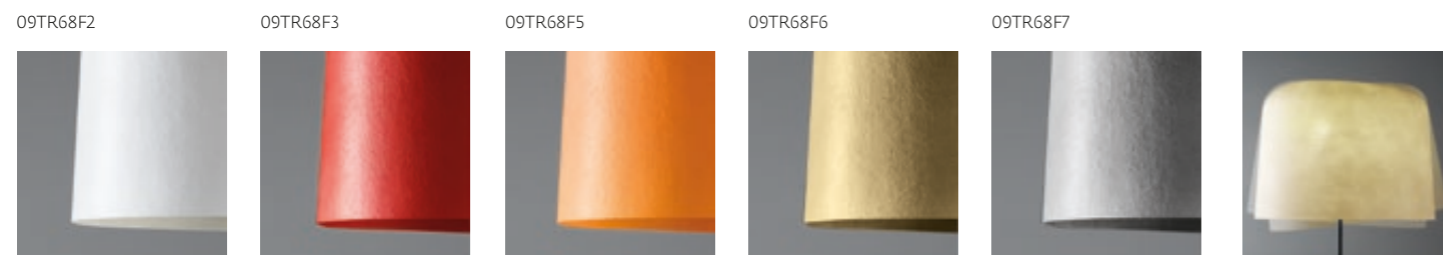

Ola / Terra / Floor





Lampada da terra con paralume in fibra di vetro in cinque differenti colori e maniglia in metallo verniciato antracite. Disponibile in altri colori a richiesta.

Floor lamp with shade in fibreglass, available in five different colors. Handle in anthracite painted metal. On request any color available.

Ola move / Terra / Floor

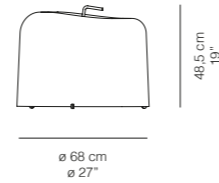

OLA move / Design Enrico Franzolini

OLA move	Terra / Floor		SORGENTI LUMINOSE / LIGHT SOURCES		CERTIFICATIONS
	MISURE / DIMENSIONS		FLUO		CE IP 20
	CM.	INCHES	LED		
	68ø x 48,5H	27ø x 19H	3x32W E27	3x16W E27	
	COLORI / COLOURS				
09AP68F2	Fibra di vetro Bianca / White Fibreglass				
09AP68F3	Fibra di vetro Rosso / Red Fibreglass				
09AP68F5	Fibra di vetro Arancio / Orange Fibreglass				
09AP68F6	Fibra di vetro Oro / Gold Fibreglass				
09AP68F7	Fibra di vetro Argento / Silver Fibreglass				
	OPZIONI / OPTIONS				
DITR	Dimmer				





Lampada da tavolo con paralume in fibra di vetro disponibile in cinque differenti colori. Stelo in metallo verniciato antracite. Disponibile in altri colori a richiesta.

Table lamp with shade in fibreglass: available in five different colors. Base in anthracite painted metal. On request any color available.

Ola / Tavolo / Table

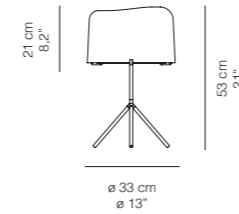

OLA / Design Enrico Franzolini

OLA Tavolo Grande Tavolo / Table		MISURE / DIMENSIONS		SORGENTI LUMINOSE / LIGHT SOURCES	
CM.	INCHES	FLUO	LED		
33ø x 21-53H	13ø x 8,26-21H	1x20W E27	1x10W E27		
COLORI / COLOURS		CERTIFICATIONS			
09TV32F2	Fibra di vetro Bianca / White Fibreglass	V CE IP 20			
09TV32F3	Fibra di vetro Rosso / Red Fibreglass				
09TV32F5	Fibra di vetro Arancio / Orange Fibreglass				
09TV32F6	Fibra di vetro Oro / Gold Fibreglass				
09TV32F7	Fibra di vetro Argento / Silver Fibreglass				





Lampada sospensione con paralume in fibra di vetro disponibile in cinque differenti colori. Disponibile in altri colori a richiesta.

Pendant lamp with shade in fibreglass: available in five different colors. On request any color available.

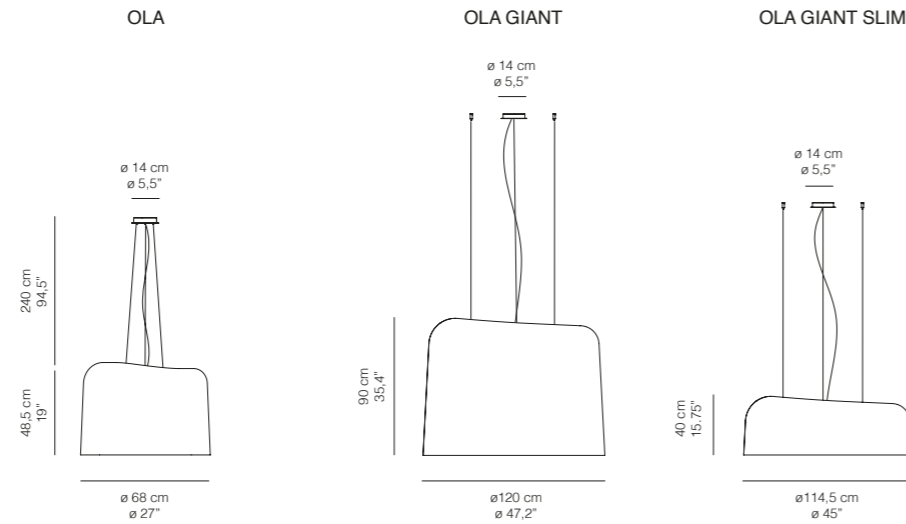

OLA / Design Enrico Franzolini

Sospensione / Pendant		SORGENTI LUMINOSE / LIGHT SOURCES	
MISURE / DIMENSIONS		FLUO	LED
CM.	INCHES		
OLA	68ø x 48,5-240H	27ø x 19-94,5H	3x33W E27 3x16W E27
OLA GIANT	120ø x 90-500H	47,2ø x 35,4-196H	3x33W E27 3x16W E27
OLA GIANT SLIM	114,5ø x 40-500H	45ø x 15,8-196H	3x33W E27 3x16W E27
COLORI / COLOURS		CERTIFICATIONS	
09SP68F2	Fibra di vetro Bianca / White Fibreglass	V CE IP 20	
09SP68F3	Fibra di vetro Rosso / Red Fibreglass		
09SP68F5	Fibra di vetro Arancio / Orange Fibreglass		
09SP68F6	Fibra di vetro Oro / Gold Fibreglass		
09SP68F7	Fibra di vetro Argento / Silver Fibreglass		
OPZIONI / OPTIONS			
SMT	Sospensione cablaggio lunghezza cavi mt. 5,00 / Pendant with longer cables mt. 5.00		
09SPDIFF	Diffusore in metacrilato opalino / Diffuser in opaline methacrylate.		
EDIZIONI SPECIALI / SPECIAL EDITIONS			
09SPITF2/3/5/6/7	OLA GIANT Fibra di vetro / Fibreglass Bianca / White (2) Rosso / Red (3) Arancio / Orange (5) Oro / Gold (6) Argento / Silver (7)		
09SP2TF2/3/5/6/7	OLA GIANT SLIM Fibra di vetro / Fibreglass Bianca / White (2) Rosso / Red (3) Arancio / Orange (5) Oro / Gold (6) Argento / Silver (7)		
Cablaggio lunghezza 5mt e diffusore di serie			

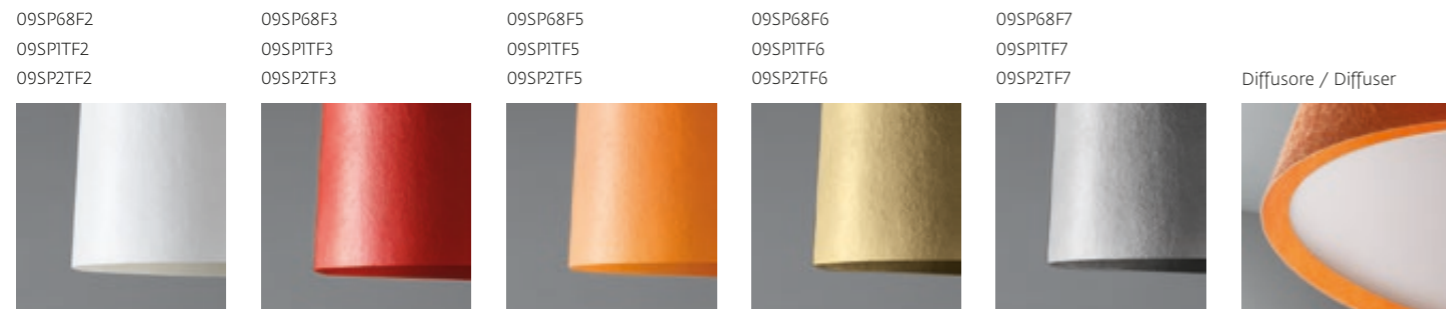

Ola / Sospensione / Pendant

OLA Slim /

Design Enrico Franzolini



Lampada che può essere montata da parete oppure a soffitto. Il paralume in fibra di vetro in cinque differenti colori. Disponibile in altri colori a richiesta.

A wall or ceiling mounted lamp. Shade in fibreglass: available in five different colors. On request any color available.

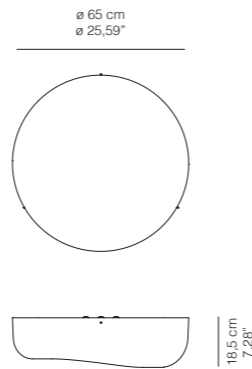

OLA Slim wall / ceiling / Design Enrico Franzolini

Parete / Wall / Applique	Soffitto / Ceiling / Plafonnier	SORGENTI LUMINOSE / LIGHT SOURCES	
MISURE / DIMENSIONS			
CM.	INCHES	FLUO	LED
65ø x 18,5	25,59ø x 7,28	3x32W E27	3x16W E27
COLORI / COLOURS		CERTIFICATIONS	
09PA65F2	Fibra di vetro Bianca / White Fibreglass	V CE IP 20	
09PA65F3	Fibra di vetro Rosso / Red Fibreglass		
09PA65F5	Fibra di vetro Arancio / Orange Fibreglass		
09PA65F6	Fibra di vetro Oro / Gold Fibreglass		
09PA65F7	Fibra di vetro Argento / Silver Fibreglass		

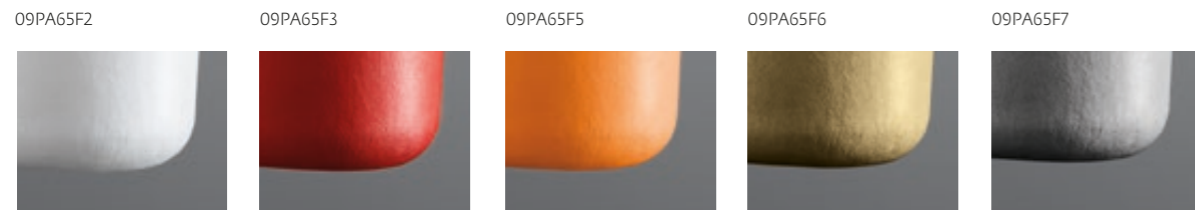

Ola Slim / Soffitto / Ceiling



Ola Slim/ Parete / Wall-mounted





Lampada sospensione con paralume in fibra di vetro disponibile in cinque differenti colori. Disponibile in altri colori a richiesta.

Pendant lamp with shade in fibreglass: available in five different colors. On request any color available.

Ola Fly / Sospensione / Pendant

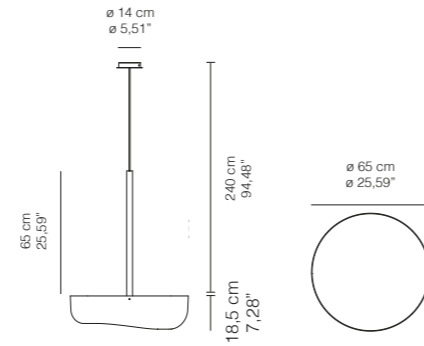

OLA Fly / Design Enrico Franzolini

Sospensione / Pendant		SORGENTI LUMINOSE / LIGHT SOURCES	
MISURE / DIMENSIONS		FLUO	LED
CM.	INCHES		
65ø x 18,5-240H	25,59ø x 7,28-94,48H	3x32W E27	3x16W E27
COLORI / COLOURS		CERTIFICATIONS	
09SP65F2	Fibra di vetro Bianca / White Fibreglass	V CE IP 20	
09SP65F3	Fibra di vetro Rosso / Red Fibreglass		
09SP65F5	Fibra di vetro Arancio / Orange Fibreglass		
09SP65F6	Fibra di vetro Oro / Gold Fibreglass		
09SP65F7	Fibra di vetro Argento / Silver Fibreglass		
OPZIONI / OPTIONS			
5MT	Sospensione cablaggio lunghezza cavi mt. 5,00 / Pendant with longer cables mt. 5,00		
09SPDIFL	Schermo superiore in metacrilato / Methacrylate top screen		

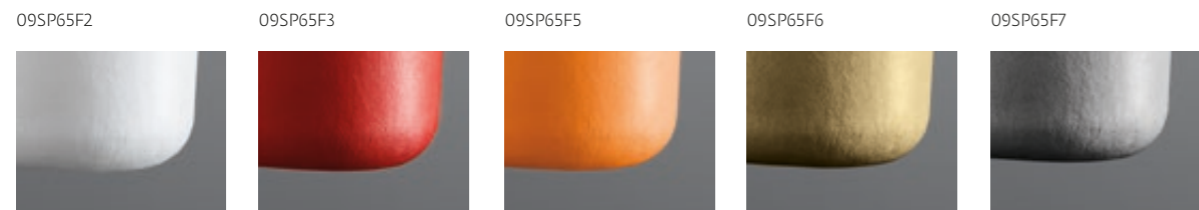

Con Elios il designer Enrico Franzolini continua la sperimentazione ed il percorso di ricerca su come la luce, la forma ed il materiale possano intrecciarsi per ottenere oggetti, emozioni ed atmosfere particolari che ci accompagnino nei momenti della nostra vita quotidiana. Oro ed argento sono le nuove colorazioni del paralume in fibra di vetro che si uniscono a quelle più tradizionali quali il bianco e l'arancio. La sorgente scelta è il LED dimmerabile, molto performante ed idoneo ad illuminare spazi ampi con un bassissimo consumo.

Mit Elios setzt der Designer Enrico Franzolini seine Forschungen fort um nach Möglichkeiten zu suchen, wie Licht, Formen und Materialien zu neuen Leuchtobjekten, Emotionen und Atmosphären die uns im täglichen Leben begleiten verbunden werden können. Gold und Silber sind die neuen Farben des Lampenschirmes aus Glasfaser die sich zu den traditionellen Farben wie Weiß und Orange hinzu gesellen. Das sehr leistungsfähige, dimmbare LED Licht eignet sich zur Ausleuchtung von großen Räumen bei niedrigstem Energieverbrauch.





Lampada da terra con paralume in fibra di vetro disponibile nelle colorazioni bianco, arancio, argento e oro. Base in metallo verniciato antracite; sorgente LED luce calda. Dimmerabile.

Floor lamp with shade in fibreglass available in white, orange, silver and gold finishes. Base in anthracite painted metal. Warm LED light source. Dimmable.



ELIOS / Designed by Enrico Franzolini

ELIOS	Terra / Floor		SORGENTI LUMINOSE / LIGHT SOURCES		with dimmer
	MISURE / DIMENSIONS				
	CM	INCHES	LED		
	35ø x 170H	13,78ø x 66,93H	95W - Lumen 10100 - 2700K		
			LED INCLUSO / LED INCLUDED		
	COLORI / COLOURS		CERTIFICATIONS		
25TR01NB	Fibra di vetro Bianca / White Fibreglass		CE IP 20 CLASSE 1		
25TR01N5	Fibra di vetro Arancio / Orange Fibreglass				
25TR01NA	Fibra di vetro Argento / Silver Fibreglass				
25TR01NG	Fibra di vetro Oro / Gold Fibreglass				

LED

25TR01NB



25TR01N5



25TR01NA



25TR01NG



BALANCE /

Designed by Thomas Feichtner

L'aspetto della Balance da tavolo è definito da un cavo, un tubo in alluminio e da una lampadina LED.

Proprio come una mera lampadina pendente dal soffitto, questa lampada da tavolo è ridotta all'essenziale.

Soltanto la sofisticata deformazione conferisce alla lampada la possibilità di regolazione.

L'interazione di angoli, raggi e linee si traduce in un apparecchio deciso e definito in termini di costruzione e forme.

The appearance of the t Table Light is defined by the cable, the aluminum tube and the LED illuminant.

Like the classic bare light bulb hanging on a cord from the ceiling the Balance Table Light is reduced to the bare essentials. Only the sophisticated deformation of the tube provides the lamp with the benefit of adjustability.

The interplay of angles, radiuses and lines results in an object which is conclusive in terms of construction and form.





Lampada da tavolo in alluminio verniciato bianco e verniciato nero. Illuminazione LED luce calda con diffusione diretta.

Table lamp in white and black painted aluminum. Led lighting -warm light- with direct light emission.

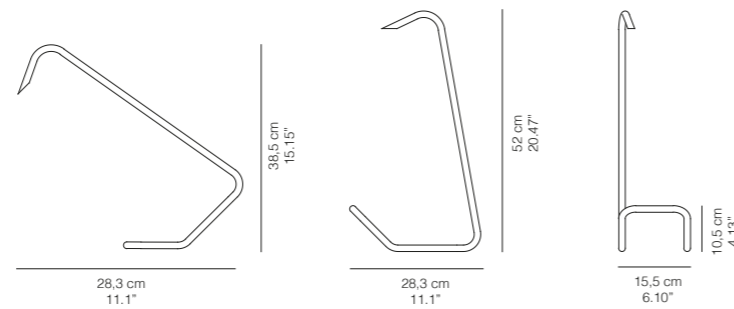

BALANCE / Designed by Thomas Feichtner

BALANCE	Tavolo / Table		SORGENTI LUMINOSE / LIGHT SOURCES	
	MISURE / DIMENSIONS			
	CM.	INCHES	LED	
OBTVILN-B	15,5 x 52H	6.10 x 20.47H	3W 120lm CRI 80 Luce calda / Warm light	
	COLORI / COLOURS		CERTIFICATIONS	
OBTVILN-B	Alluminio nero goffrato con cavo ed alimentatore nero / Textured black aluminium with black cable and power supply		IP 20	
OBTVILN-W	Alluminio bianco goffrato RAL9016 con cavo e alimentatore bianco / Textured white aluminium with white cable and power supply			
	OPZIONI / OPTIONS			
	Spina inglese tipo G / UK Plug type G			
	Spina US tipo A / US Plug type A			

OBTVILN-B



OBTVILN-W



Balance / Tavolo / Table

BABEL /

Design Fabio Flora

Da Babele nasce la nostra società. Babele è la nostra società. Suo simbolo, della sua genesi e sopravvivenza, una torre mai terminata, un tronco di cono che sale a spirale.

Oggi la torre è collassata (la spirale non sale soltanto, sale e scende) eppure c'è ancora; è in equilibrio precario ed è alimentata da una luce interna.

Our society was born from Babele. Babele is our society.

A symbol of its genesis and survival, a tower which was never finished, a cone log that rises like a spiral.

Today the tower is collapsed (the spiral does not only rise, but rises and falls) nevertheless it still exists; its precarious equilibrium is nourished from an inner light.





Lampada da terra con paralume in tessuto Honeycomb in colore bianco o nero. Treppiede in metallo verniciato bianco.

Floor lamp with shade in Honeycomb canvas fabric, in white or black. Tripod in white-painted metal.

Babel / Terra / Floor

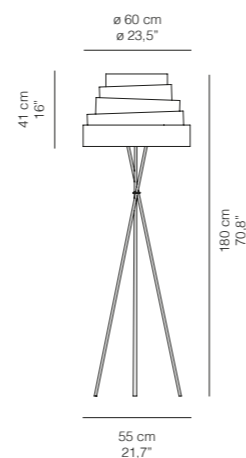

BABEL / Design Fabio Flora

BABEL	Terra / Floor		SORGENTI LUMINOSE / LIGHT SOURCES	
	MISURE / DIMENSIONS		FLUO	
	CM.	INCHES	LED	
	60ø x 41-180H	23,5ø x 16-70,8H	3x27W E27 3x16W E27	
	COLORI / COLOURS		CERTIFICATIONS	
10TRWH01	Tessuto Honeycomb Bianco / White Honeycomb Canvas			
10TRBK02	Tessuto Honeycomb Nero / Black Honeycomb Canvas			
	OPZIONI / OPTIONS			
DITR	Dimmer			



10TRBK02



10TRWH01



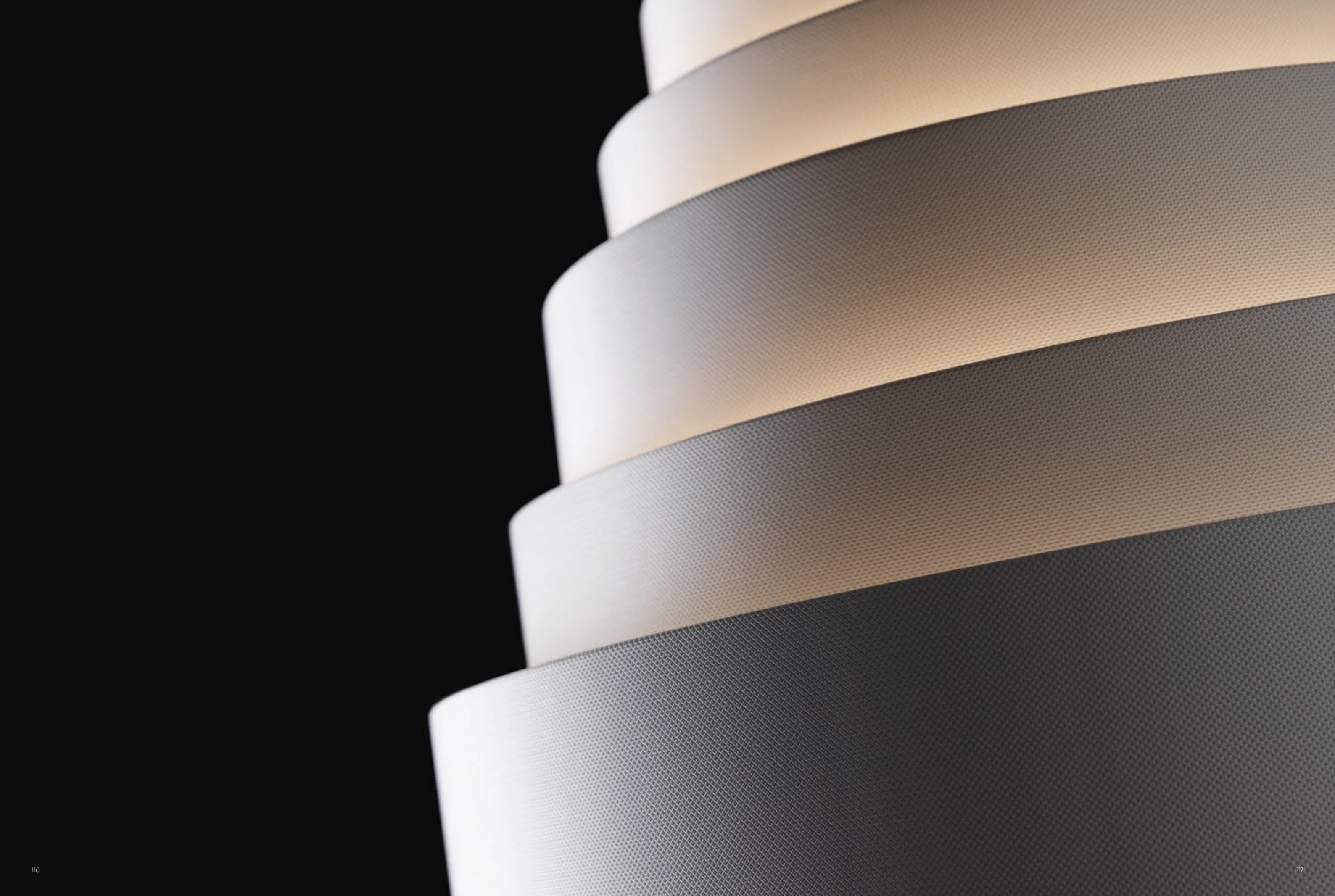

Lampada da sospensione con paralume in tessuto Honeycomb in colore bianco o nero. Supporto in metallo verniciato bianco. Diffusore opalino.

Pendant lamp with shade in Honeycomb canvas fabric, in white or black. Ceiling fitting in white-painted metal. With opaline diffuser.

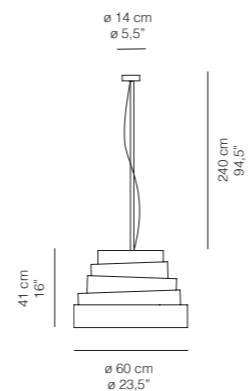

BABEL / Design Fabio Flora

BABEL	Terra / Pendant			
	MISURE / DIMENSIONS		SORGENTI LUMINOSE / LIGHT SOURCES	
	CM.	INCHES	FLUO	LED
	60ø x 41-240H	23,5ø x 16-94,5H	3x23W E27	3x16W E27
	COLORI / COLOURS		CERTIFICATIONS	
10SPWH01	Tessuto Honeycomb Bianco / White Honeycomb Canvas			
10SPBK02	Tessuto Honeycomb Nero / Black Honeycomb Canvas			
	OPZIONI / OPTIONS			
5MT	Sospensione cablaggio lunghezza cavi mt. 5,00 / Pendant with longer cables mt. 5,00			



10SPWH01

10SPBK02



Babel / Sospensione / Pendant

AFRA /

Design Enrico Franzolini

Una quasi sfera di vetro soffiato con una scanalatura mediana ad accogliere una cuffia tessuta a mano. Texture tessili uniche che filtrano la luce in modo sempre diverso. L'esaltazione del fatto a mano.

A nearly sphere of blown glass with a median groove which holds a hand crochet cap. Crocheted in an unique weave texture that always filters the light in various ways.



Lampada da terra a luce diffusa.
Diffusore in vetro opalino, soffiato a bocca, con finitura esterna acidata, bianca. Base in alluminio verniciato grigio chiaro. Cuffia decorativa opzionale nei colori: nero o beige.

Floor lamp providing diffused light. Diffuser consisting of an externally acid-etched hand blown, flashed opaline white glass. Base in aluminium painted light grey. On request, decorative cap in black or beige.

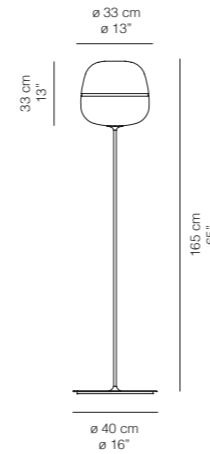

AFRA /

Design Enrico Franzolini

AFRA	Terra / Floor		SORGENTI LUMINOSE / LIGHT SOURCES	
	MISURE / DIMENSIONS		FLUO	LED
	CM.	INCHES		
13TRWH01	40-33ø x 165H	16-13ø x 65H	1x23W E27	1x16W E27
	COLORI / COLOURS		CERTIFICATIONS	
	Vetro acidato bianco / White acid-etched glass			
	OPZIONI / OPTIONS			
13NETWH	Cuffia Beige / Beige cap			
13NETBK	Cuffia Nera / Black cap			
DITR	Dimmer			

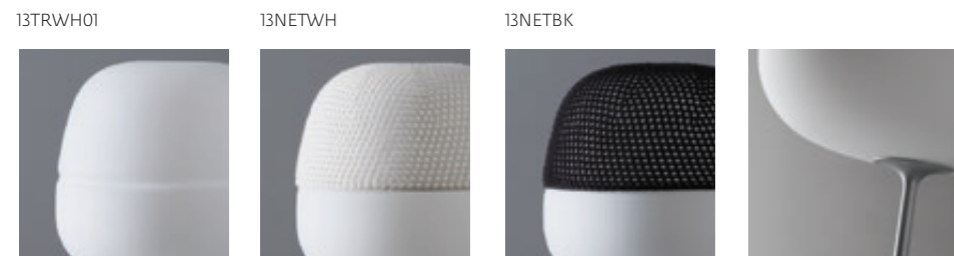



Lampada da tavolo a luce diffusa. Diffusore in vetro opalino, soffiato a bocca, con finitura esterna acidata, bianca. Base in alluminio verniciato grigio chiaro. Cuffia decorativa opzionale nei colori: nero o beige.

Table lamp providing diffused light. Diffuser consisting of an externally acid-etched hand blown, flashed opaline glass available in white. Steel suspension cable. Steel suspension cable. Ceiling fitting painted light grey. On request, decorative cap in black or beige.

Afra / Tavolo / Table

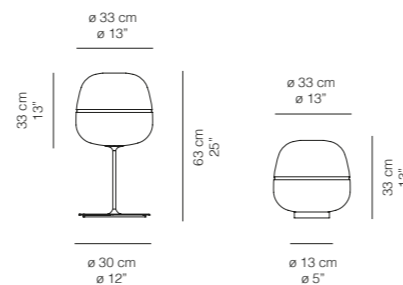

AFRA / Design Enrico Franzolini

AFRA	Tavolo / Table		SORGENTI LUMINOSE / LIGHT SOURCES		CERTIFICATIONS
	MISURE / DIMENSIONS				
	CM.	INCHES	FLUO	LED	
13TVWH01	33ø x 63H	13ø x 25H	1x23W E27	1x16W E27	
	COLORI / COLOURS				
	Vetro acidato bianco / White acid-etched glass				
AFRA	Da appoggio / Table desk		SORGENTI LUMINOSE / LIGHT SOURCES		CERTIFICATIONS
	MISURE / DIMENSIONS				
	CM.	INCHES	FLUO	LED	
13APWH01	33 ø x 33H	13 ø x 13H	1x23W E27	1x16W E27	
	COLORI / COLOURS				
	Vetro acidato Bianco / White acid-etched glass				
	OPZIONI / OPTIONS				
13NETWH	Cuffia Beige / Beige cap				
13NETBK	Cuffia Nera / Black cap				
DITV	Dimmer				

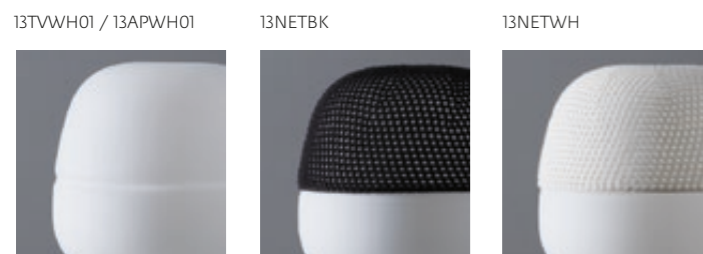

Afra / Da appoggio / Table desk

Lampada da sospensione a luce diffusa. Diffusore in vetro opalino, soffiato a bocca, con finitura esterna acidata, bianca. Base in alluminio verniciato grigio chiaro. Cuffia decorativa opzionale nei colori: nero o beige.

Pendant lamp providing diffused light. Diffuser consisting of an externally acid-etched hand blown, flashed opaline glass available in white. Steel suspension cable. Ceiling fitting painted light grey. On request, decorative cap in black or beige.

Afra / Sospensione / Pendant

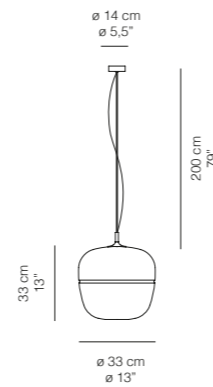

AFRA / Design Enrico Franzolini

AFRA	Sospensione / Pendant		SORGENTI LUMINOSE / LIGHT SOURCES	
	MISURE / DIMENSIONS			
	CM.	INCHES	FLUO	LED
13SPWH01	33ø x 33-200H	13ø x 13-79H	1x23W E27	1x16W E27
	COLORI / COLOURS		CERTIFICATIONS	
	Vetro acidato Bianco / White acid-etched glass			
	OPZIONI / OPTIONS			
13NETWH	Cuffia Beige / Beige cap			
13NETBK	Cuffia Nera / Black cap			
5MT	Sospensione cablaggio lunghezza cavi mt. 5,00 / Pendant with longer cables mt. 5,00			



13SPWH01



13NETWH



13NETBK

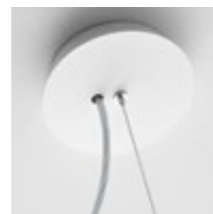

PEGGY /

Design Enrico Franzolini

Collezione tavolo e terra caratterizzata dalla forma sinuosa e dinamica del paralume nelle versioni: juta naturale e fibra di vetro bianca o nera. Base in metallo cromato.

Table and floor collection with a sleek and streamlined shade in fibreglass white or black and jute natural fabric available. Base in chromed metal.



Lampada da tavolo dalla forma sinuosa e dinamica del paralume. Disponibile in fibra di vetro bianca o nera dalle sfumature grigio chiaro e Juta naturale, con base in metallo cromato.

Table lamp with a sleek and streamlined shade. Available in fibreglass white, black with light grey hues or Jute natural with base in chromed metal.

Peggy / Tavolo / Table

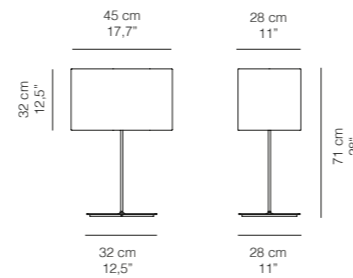

PEGGY / Design Enrico Franzolini

PEGGY	Tavolo / Table		SORGENTI LUMINOSE / LIGHT SOURCES		
	MISURE / DIMENSIONS		FLUO		
	CM.	INCHES	LED		
	45 x 28 x 32-71H	17,7 x 11 x 12,5-28H	1x20W E27		
			1x10W E27		
	COLORI / COLOURS		CERTIFICATIONS		
07TVWH01	Fibra di vetro Bianco / White Fibreglass				
07TVBK01	Fibra di vetro Nero / Black Fibreglass				
07TVJU01	Juta naturale / Jute natural				
DITV	Dimmer				



Lampada da terra dalla forma sinuosa e dinamica del paralume. Disponibile in fibra di vetro bianca, nera dalle sfumature grigio chiaro e Juta naturale, con base in metallo cromato.

Floor lamp with a sleek and streamlined shade. Available in fibreglass white, black with light grey hues or Jute natural, with base in chromed metal.

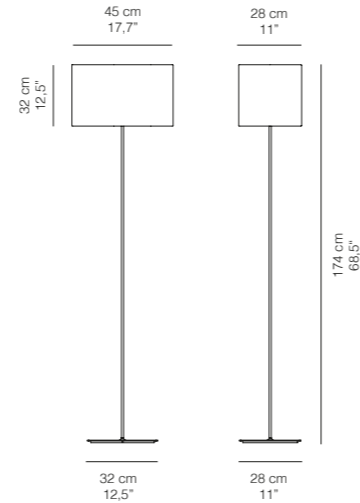

PEGGY / Design Enrico Franzolini

PEGGY		Terra / Floor		SORGENTI LUMINOSE / LIGHT SOURCES		CERTIFICATIONS	
MISURE / DIMENSIONS		MISURE / DIMENSIONS		SORGENTI LUMINOSE / LIGHT SOURCES		CERTIFICATIONS	
CM.	INCHES	FLUO	LED				
45 x 28 x 32-174H	17,7 x 11 x 12,5-68,5H	1x20W E27	1x10W E27				
COLORI / COLOURS							
07TRWH01	Fibra di vetro Bianco / White Fibreglass						
07TRBK01	Fibra di vetro Nero / Black Fibreglass						
07TRJU01	Juta naturale / jute natural						
DITR	Dimmer						

07TRBK01



07TRWH01



07TRJU01



Peggy / Terra / Floor



BLONDE /

Design Massimiliano Mornati

Il concept di Blonde si basa su elementi quali versatilità, fantasia, finiture, che possono essere scelti e decisi dal designer per personalizzare e caratterizzare ogni singolo progetto.

Una forma trapezoidale, dal gusto postindustriale forse "radical chic" in grado di dipingere ed illuminare lo spazio.

L'alluminio viene verniciato con la finitura desiderata dal designer oppure scegliendo tra l'effetto cemento, grigio ombra, bronzo spazzolato o il bianco.

Anche la lunghezza può essere personalizzabile fino ad un massimo di 5 metri.

La sorgente luminosa LED, diretta ed indiretta, con funzione dimmer, garantisce un ottimo comfort visivo per ogni esigenza progettuale.

Blonde concept rests on versatility, creativity and finishes elements that can be chosen by designers and architects in order to customize and mark out every single project.

A trapezoidal shape, with a postindustrial taste, paints and lights up the space.

The aluminium could be painted both with a finish required by the designer and with cement, anthracite, brushed bronze and white. Furthermore also the length could be customized till a maximum of 5 meters.

The LED lamp, direct or not, with dimmer optional, assures a perfect visual comfort for every designing need.





Il concept di Blonde si basa su elementi quali versatilità, fantasia, finiture, che possono essere scelti e decisi dal designer per personalizzare e caratterizzare ogni singolo progetto.

The Blonde concept is based on versatility, fantasy, finishes elements, which can be chosen and defined by the designer to customize every single project.

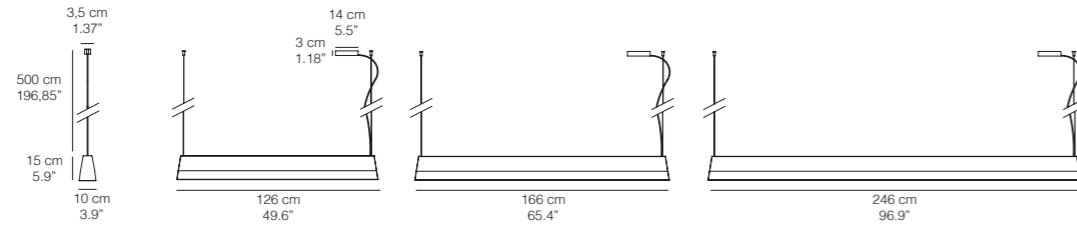

BLONDE / Design Massimiliano Mornati

	MISURE / DIMENSIONS	COLORI / COLOURS	SORGENTI LUMINOSE / LIGHT SOURCES
BLONDE 126			LED 110-240V - 2700K (3000K On Demand) DIMMERABILE: ALL IN ONE - DALI + PUSH DIMMER + 1-10V
29SP1260-W	126X15X10 49.6X5.9X3.9	Bianco / White	84W - LUCE DIRETTA+INDIRETTA - DIRECT/INDIRECT LIGHT - 7000 Lumen
29SP1260-G	126X15X10 49.6X5.9X3.9	Grigio ombra / Anthracite	84W - LUCE DIRETTA+INDIRETTA - DIRECT/INDIRECT LIGHT - 7000 Lumen
29SP1260-N	126X15X10 49.6X5.9X3.9	Ottone bronzato / Bronzed brass	84W - LUCE DIRETTA+INDIRETTA - DIRECT/INDIRECT LIGHT - 7000 Lumen
29SP1260-E	126X15X10 49.6X5.9X3.9	Cemento / Concrete	84W - LUCE DIRETTA+INDIRETTA - DIRECT/INDIRECT LIGHT - 7000 Lumen
BLONDE 166			
29SP1660-W	166X15X10 65.4X5.9X3.9	Bianco / White	113W - LUCE DIRETTA+INDIRETTA - DIRECT/INDIRECT LIGHT - 9400 Lumen
29SP1660-G	166X15X10 65.4X5.9X3.9	Grigio ombra / Anthracite	113W - LUCE DIRETTA+INDIRETTA - DIRECT/INDIRECT LIGHT - 9400 Lumen
29SP1660-N	166X15X10 65.4X5.9X3.9	Ottone bronzato / Bronzed brass	113W - LUCE DIRETTA+INDIRETTA - DIRECT/INDIRECT LIGHT - 9400 Lumen
29SP1660-E	166X15X10 65.4X5.9X3.9	Cemento / Concrete	113W - LUCE DIRETTA+INDIRETTA - DIRECT/INDIRECT LIGHT - 9400 Lumen
BLONDE 246			
29SP2460-W	246X15X10 96.9X5.9X3.9	Bianco / White	171W - LUCE DIRETTA+INDIRETTA - DIRECT/INDIRECT LIGHT - 14200 Lumen
29SP2460-G	246X15X10 96.9X5.9X3.9	Grigio ombra / Anthracite	171W - LUCE DIRETTA+INDIRETTA - DIRECT/INDIRECT LIGHT - 14200 Lumen
29SP2460-N	246X15X10 96.9X5.9X3.9	Ottone bronzato / Bronzed brass	171W - LUCE DIRETTA+INDIRETTA - DIRECT/INDIRECT LIGHT - 14200 Lumen
29SP2460-E	246X15X10 96.9X5.9X3.9	Cemento / Concrete	171W - LUCE DIRETTA+INDIRETTA - DIRECT/INDIRECT LIGHT - 14200 Lumen
OPZIONI / OPTIONS			
29SP(-W)(-G)	Lunghezza personalizzabile da 2600mm a 5000mm (W-G) / Length customized from 2600mm to 5000mm (W-G)		
29SP(-N)(-E)	Lunghezza personalizzabile da 2600mm a 5000mm (N-E) / Length customized from 2600mm to 5000mm (N-E)		
CERTIFICAZIONI / CERTIFICATIONS			
	CE IP 20 CLASSE 1		

BIANCO
WHITE



29SP1260-W
29SP1660-W
29SP2460-W

GRIGIO OMBRA
ANTHRACITE



29SP1260-G
29SP1660-G
29SP2460-G

OTTONE BRONZATO
BRONZED BRASS



29SP1260-N
29SP1660-N
29SP2460-N

CEMENTO
CONCRETE



29SP1260-E
29SP1660-E
29SP2460-E

ROSONE
CEILING ROSE



WARM /

Design Enrico Franzolini

Essere alla ricerca di geometrie morbide e sinuose, cercare qualcosa che esca dall'ombra. Trovare Warm, una lampada da interno ed esterno; la linea esalta il materiale e viceversa, come quando il diffusore in polietilene, in un gioco di trasparenze, si veste di una rete sensuale creando atmosfere suggestive. L'ispirazione e la tecnologia insieme per un risultato di luce calda ed avvolgente.

Searching for soft, sinuous shapes, looking for something that steps out from the shade. Discover Warm, a lamp for inside and outside, an evocative figure; the shape exalts the material and vice versa, like when the polyethylene spreader, playing with transparencies, puts on a sensual net creating suggestive atmospheres. Inspiration and technology together result in warm, embracing light.





Lampada da terra con diffusore in polietilene bianco e base in metallo zincato verniciato in colore nero anche per utilizzo outdoor. A richiesta, rete tessile di copertura bianca o nera.

Floor lamp with white polyethylene shade and metallic base, painted black for outdoor use. On request, black or white net.

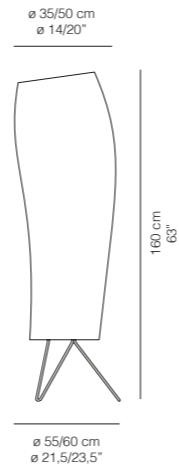

WARM / Design Enrico Franzolini

WARM INDOOR	Terra / Floor	SORGENTI LUMINOSE / LIGHT SOURCES		
	MISURE / DIMENSIONS	FLUO	LED	
	CM. INCHES	1x40W E27	1x16W E27	with dimmer
	35/50 - 55/60ø x 160H 14/20 - 21,5/23,5ø x 63H			CERTIFICATIONS
	COLORI / COLOURS			
08WAIN02	Polietilene bianco / White polyethylene			
	Dimmer incluso / Dimmer included			
WARM OUTDOOR	Terra / Floor	SORGENTI LUMINOSE / LIGHT SOURCES		
	MISURE / DIMENSIONS	FLUO	LED	
	CM. INCHES	1x40W E27	1x16W E27	
	35/50 - 55/60ø x 160H 14/20 - 21,5/23,5ø x 63H			CERTIFICATIONS
	COLORI / COLOURS			
08WAOT01	Polietilene bianco / White polyethylene			
	OPZIONI / OPTIONS			
08WANETWH	Rete bianca / White net			
08WANETBK	Rete nera / Black net			

08WAIN02 / 08WAOT01 08WANETBK 08WANETWH

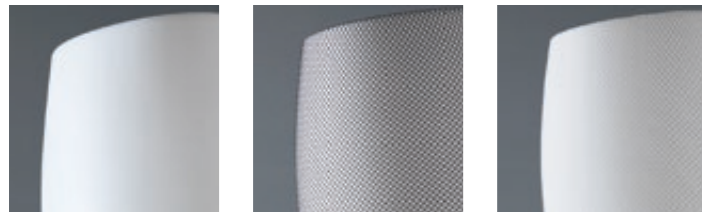

ESCAPE /

Design Serena Papait

Escape è una lampada che nasce con l'intento di sperimentare la dinamicità della luce in un contesto di staticità, di creare una sorta di vibrazione che si manifesta con la lettura di diversi livelli di luce.

La lampada è composta da una serie di elementi perfettamente orizzontali e paralleli tra di loro, che rappresentano la volontà di ricercare mediante la forma un equilibrio e un ordine naturale.

Escape is a lamp that has been designed in the attempt to experience the dynamism of light in a context of stillness a kind of vibration that manifests with the diffusion of the light at different levels.

The lamp is composed of a series of perfectly horizontal elements, parallel between them, that represent the will to search, by means of this shape, an equilibrium and natural order.





Lampada da sospensione composta da 5 elementi in alluminio verniciato bianco, disposti orizzontalmente ed in modo parallelo. Diffusore in metacrilato opalino.

Pendant lamp made up with 5 elements in white painted aluminium, horizontally arranged and parallel to each other. Shade in opaline methacrylate.

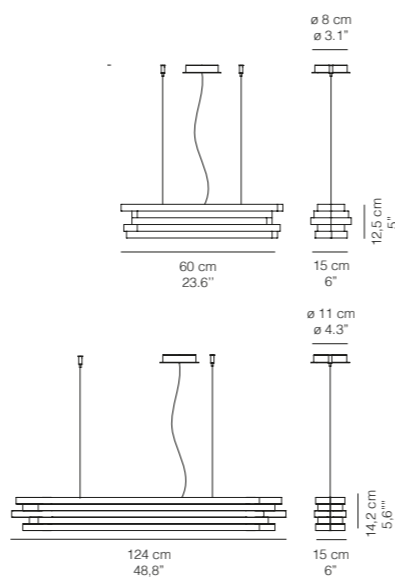

ESCAPE / Design Serena Papait

ESCAPE	Sospensione / Pendant		SORGENTI LUMINOSE / LIGHT SOURCES		CERTIFICATIONS
	MISURE / DIMENSIONS		FLUO	LED	
	CM.	INCHES			
12SP06FW	60 x 15 x 12,5H	23,5 x 6 x 5H	2x20W-E27	2x10W E27	
12SPWH01	124 x 15 x 14,2H	48,8 x 6 x 5,6H	2x39W-T5 G5		
	COLORI / COLOURS		OPZIONI / OPTIONS		
	Alluminio verniciato Bianco / White painted aluminium		Sospensione cablaggio lunghezza cavi mt. 5,00 / Pendant with longer cables mt. 5,00		
			Dimmerabile DALI (12SPWH01) / Dimmable DALI (12SPWH01)		



ESCAPE 124 - 12SPWH01



ESCAPE 60 - 12SP06FW









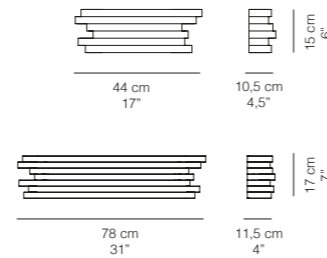

Lampada da parete composta da elementi in alluminio verniciati bianco, disposti orizzontalmente ed in modo parallelo.
Diffusore in metacrilato opalino.

Wall-mounted lamp made up from elements in white painted aluminium, horizontally arranged and parallel to each other. Shade in opaline methacrylate.

Escape 44-78 / Parete / Wall-mounted



ESCAPE / Design Serena Papait

ESCAPE	Parete / Wall		SORGENTI LUMINOSE / LIGHT SOURCES		CERTIFICATIONS
	MISURE / DIMENSIONS		FLUO	LED	
	CM.	INCHES			
12PAWH44	44 x 10,5 x 15H	17 x 4 x 6H	2x9W E14 	2x4,5W E14 	CE IP 20 
12PAWH78	78 x 11,5 x 17H	31 x 4,5 x 7H	2x24W-T5 G5 		CE IP 20 
	COLORI / COLOURS				
	Alluminio verniciato Bianco / White painted aluminium				
	OPZIONI / OPTIONS				
DIMM	Dimmerabile DALI (12PAWH78) / Dimmable DALI (12PAWH78)				



ESCAPE 78 - 12PAWH78



ESCAPE 44 - 12PAWH44



Lampada da parete composta da 3 elementi in alluminio verniciati bianco, disposti orizzontalmente ed in modo parallelo. Diffusore in metacrilato opalino. Disponibile con sorgente LED o fluorescente. Dimmerabili su richiesta.

Wall-mounted lamp made up from 3 elements in white painted aluminium, horizontally arranged and parallel to each other. Shade in opaline methacrylate. Available with LED technology or fluorescent bulb. Dimmerable DALI on request.

ESCAPE 50



ESCAPE 80



ESCAPE 110

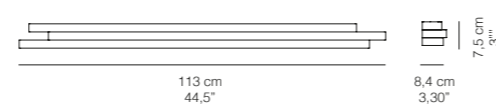

ESCAPE / Design Serena Papait

Parete/ Wall		SORGENTI LUMINOSE / LIGHT SOURCES		
MISURE / DIMENSIONS				
ESCAPE 50	CM. INCHES	FLUO	LED	
12PA05LW (MW)	50 x 8,4 x 7,5H 19,7 x 3,30 x 3H		12W Lumen 1300 - 2700K	(MW) Dimmer DALI
ESCAPE 80				
12PA08LW (MW)	80 x 8,4 x 7,5H 31,5 x 3,30 x 3H		24W Lumen 2600 - 2700K	(MW) Dimmer DALI
12PA08FW (GW)	80 x 8,4 x 7,5H 31,5 x 3,30 x 3H	1x24W-T5 G5		(GW) Dimmer DALI
ESCAPE 110				
12PA11LW (MW)	113 x 8,4 x 7,5H 44,5 x 3,30 x 3H		36W Lumen 3900 - 2700K	(MW) Dimmer DALI
12PA11FW (GW)	113 x 8,4 x 7,5H 44,5 x 3,30 x 3H	1x39W-T5 G5		(GW) Dimmer DALI
COLORI / COLOURS		LED INCLUSO / LED INCLUDED		CERTIFICATIONS
Alluminio verniciato Bianco / White painted aluminium				
OPZIONI / OPTIONS				
LED 3000K su richiesta / LED 3000K on demand				

LED

ESCAPE 110 - 12PA11LW (MW) / 12PA11FW (GW)
ESCAPE 80 - 12PA08LW (MW) / 12PA08FW (GW)

ESCAPE 50 - 12PA05LW (MW)





Lampada da parete composta da 4 elementi in metallo verniciato bianco.

Wall mounted lamp made up from 4 elements in white painted metal.

Escape cube / Parete / Wall-mounted

ESCAPE cube / Design Serena Papait

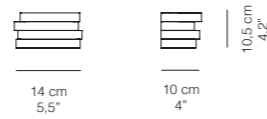

ESCAPE cube	Parete / Wall			
	MISURE / DIMENSIONS		SORGENTI LUMINOSE / LIGHT SOURCES	
	CM.	INCHES	LED	AC phase-cut dimmable
12PAWH15	14 x 10 x 10,5H	5,5 x 4 x 4,2H	1x8,7W - Lumen 800 - 2700K	
			LED INCLUSO / LED INCLUDED	CERTIFICATIONS
	COLORI / COLOURS			CE IP 20
	Metallo verniciato Bianco / White metal painted			

LED

12PAWH14



12PAWH15



TUPLA /

Design by Karboxx

Semplicità, funzionalità e razionalità sono i concetti che hanno ispirato la collezione Tupla. Una forma semplice per un utilizzo versatile, quasi universale. Funzionale, perché è una lampada che consente di illuminare abbondantemente e con efficacia lo spazio. Intelligente, perché le sorgenti LED ad elevate prestazioni garantiscono un bassissimo consumo ed una eccezionale durata nel tempo in assenza di manutenzione. Diffusore in metacrilato, struttura in alluminio e sorgente LED sono le caratteristiche tecniche di Tupla.

Simplicity, functionality and rationality are the concepts that inspired the Tupla collection. A simple shape for versatile and almost universal use. This functional lamp gives profuse and effective lighting in a space and its intelligent use of high performance LED bulbs ensure low consumption.

The bulbs are exceptionally long-lasting with no need for maintenance. Tupla has a methacrylate diffuser, an aluminium structure and an LED light source





Pratica lampada a parete con struttura in alluminio lucidato e diffusori cilindrici in metacrilato opalino.
Sorgente LED 220-240 a luce calda.
Dimmerabile a taglio di fase.

Functional wall-mounted lamp with polished aluminium structure and cylindrical diffusers in opaline methacrylate. Warm LED light source 220-240. AC phase-cut dimming.

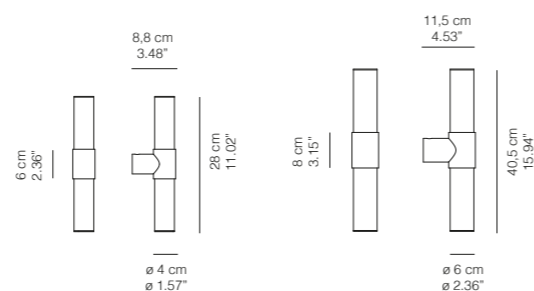

TUPLA / Design Kxx

TUPLA	Parete / Wall		SORGENTI LUMINOSE / LIGHT SOURCES		Dimmer a taglio di fase AC phase-cut dimming
	MISURE / DIMENSIONS	INCHES	LED		
TUPLA 28	CM		LED		
27PA01LC	4ø x 8,8 x 28H	1,57ø x 3,46 x 11,02H	2x4,3W - Lumen 800 - 2700K ☼		
TUPLA 40			LED INCLUSO / LED INCLUDED		
27PA02LC	6ø x 11,5 x 40,5H	2,36ø x 4,53 x 15,94	2x8,7W - Lumen 1600 - 2700K ☼		
	COLORI / COLOURS		CERTIFICATIONS		
	Struttura in alluminio lucidato / Polished aluminium structure		CE IP 44 CLASSE 1		
	Diffusore metacrilato opalino / Methacrylate opal diffuser				

LED



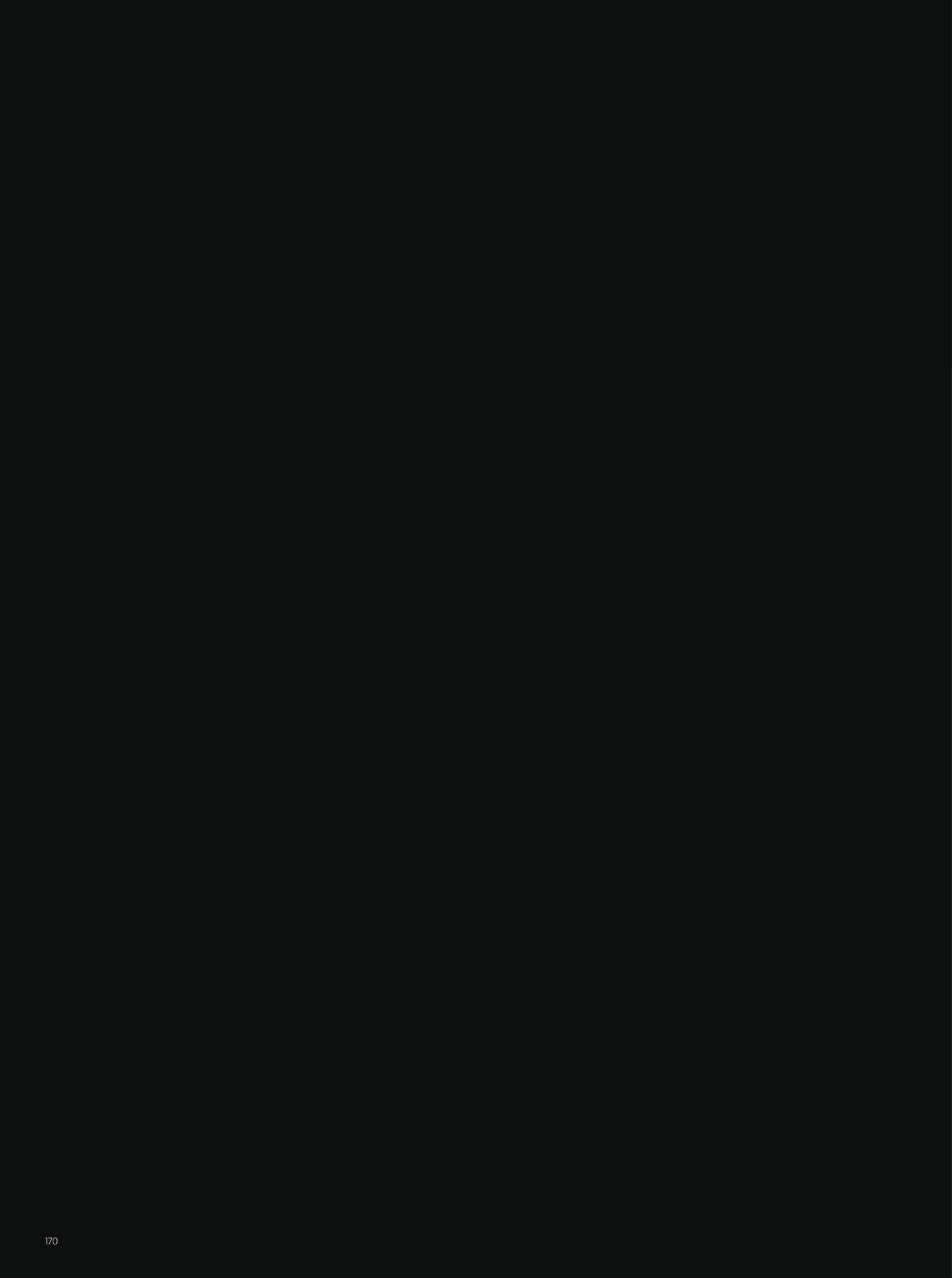

SHINE /

Designed by Moreno De Giorgio

Shine è una forma luminosa semplice, minuta e circolare, impreziosita da tratteggi di luce proiettati sul diffusore frontale. Un'ottica particolare, a misura di LED, emana un'efficace illuminazione radiale sulla parete e, grazie a 35 micro forature nascoste al suo interno, genera una gradevole texture luminosa intorno alla cornice. La magia della luce applicata alle fonti LED trasforma una piccola parte del fascio luminoso in decoro, a dimostrazione delle potenzialità espressive oltre che funzionali delle stesse.

Shine is a simple, minute, circular light form, enhanced by traces of light projected on the frontal diffuser. A special perspective, designed for an LED, emits effective radial illumination on the wall and the 35 micro-perforations hidden inside product a pleasant luminous texture around the frame. The magic of light applied to LED bulbs transforms a little part of the beam of light into decoration, demonstrating both its expressive and functional potential.



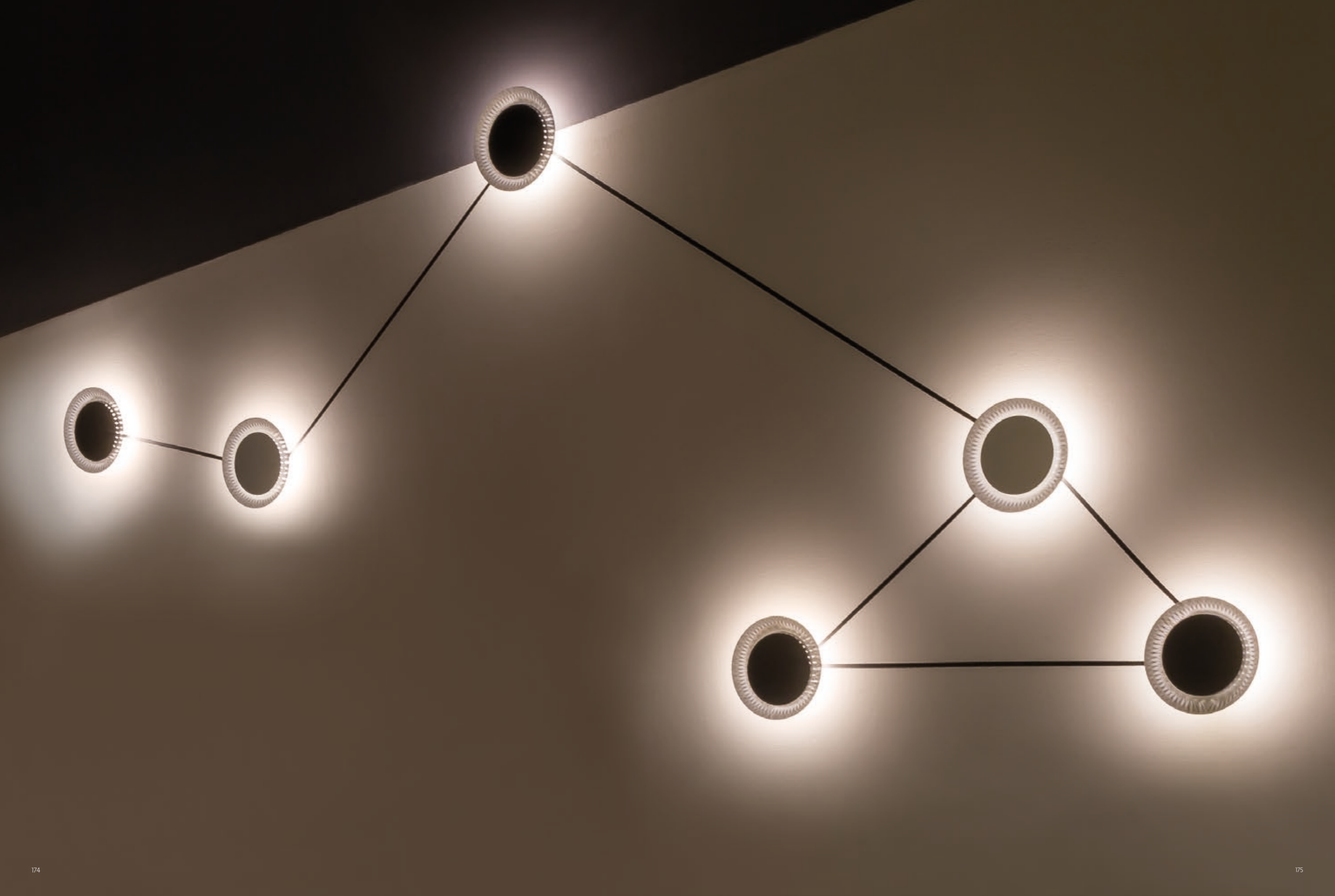

Lampada circolare da parete con struttura in metallo verniciata bianco e parte centrale tonda sempre in metallo verniciato bianco o nero a scelta. I LED diffondono luce calda con un particolare disegno grazie a 35 microforature nascoste.

Circular wall-mounted lamp with white metal structure and a central disk painted in white or black. LED light sources diffuse a warm light with a special design thanks to 35 hidden micro-perforations.

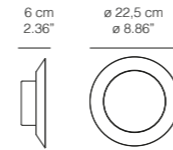

SHINE / Designed by Moreno De Giorgio

SHINE	Parete / Wall		SORGENTI LUMINOSE / LIGHT SOURCES	
	MISURE / DIMENSIONS			
	CM.	INCHES	LED	
21PA01LW	22,5ø x 6	8,86ø x 2,36	12W - Lumen 1200 - 2700K	
			LED INCLUSO / LED INCLUDED	
	COLORI / COLOURS		CERTIFICATIONS	
21PA01LW	Struttura Bianca, disco centrale Bianco / White structure, White disc		IP 20	
21PA01LN	Struttura Bianca, disco centrale Nero / White structure, Black disc			

LED

21PA01LW



21PA01LN



TURN ME! /

Design Marta Laudani e Marco Romanelli

È ai LED che in fondo dobbiamo "Turn me!": un foglio di metallo semplicemente si piega su se stesso per ospitare la luce.

Il suo aspetto minimale gli consentirà di adattarsi alle più diverse situazioni abitative e l'invenzione da cui nasce il suo nome, ovvero la possibilità di procedere ad una rotazione, consentirà a "Turn me!", con la semplicità di un gesto, di assumere molteplici e sempre mutevoli posizioni sulla parete. Luce verso l'alto, luce verso il basso, verso destra o verso sinistra: quando è isolata "Turn me" si propone come un oggetto poeticamente funzionale, mentre, qualora fosse ripetuta in serie, assumerebbe il valore di un'installazione artistica.

In the end it's the LEDs that give us "Turn me!": a sheet of metal simply folds itself to host light. Its minimal style means it can adapt to many different situations and the invention which gave it its name, that is to say the possibility to rotate, will let "Turn me!" take on multiple mutating positions on the wall, with just a simple touch. Light pointing up, light pointing down, to the left or right: when it stands alone "Turn me" is like a poetically functional object; when a series is repeated it takes on the value of an art installation.



Lampada da parete in metallo verniciato bianco opaco con sorgente LED. Può essere facilmente ruotata con la mano direzionando la luce a piacimento.

Wall light fixture in matt white painted metal with LED light source. It can be easily rotated by hand to point the light in the desired direction.

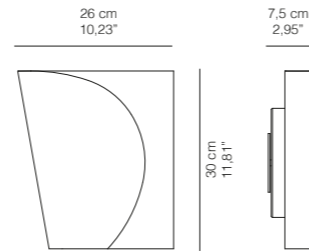

TURN ME! / Design Marta Laudani e Marco Romanelli

Parete/ Wall		SORGENTI LUMINOSE / LIGHT SOURCES	
MISURE / DIMENSIONS		LED	
CM.	INCHES		
19PA26LW	26 x 7,5 x 30H	10,23 x 2,95 x 11,81H	12W Lumen 1300 - 3000K 
COLORI / COLOURS		LED INCLUSO / LED INCLUDED	
Metallo verniciato Bianco / White painted metal		CERTIFICATIONS	
		V CE IP 20	

LED

19PA26LW

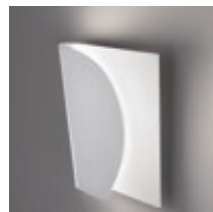

ALALUNGA /

Design Enrico Franzolini

L'incontro tra fogli metallici piegati su sé stessi per formare due ali che si contrappongono, riflessioni e giochi di luce nuove, ombre geometriche: questa è Alalunga, una nuova ed inedita interpretazione luminosa.

Metal sheets folded upon themselves to form two wings that contrast each other, reflection, new plays of light, geometric shadows: this is Alalunga, a new and unique interpretation of light.



Lampada da parete in due dimensioni con finiture esclusive. Sorgente luminosa LED.

Wall light available in two different dimensions and with exclusive finishes. LED light source.

Alalunga / Parete / Wall-mounted

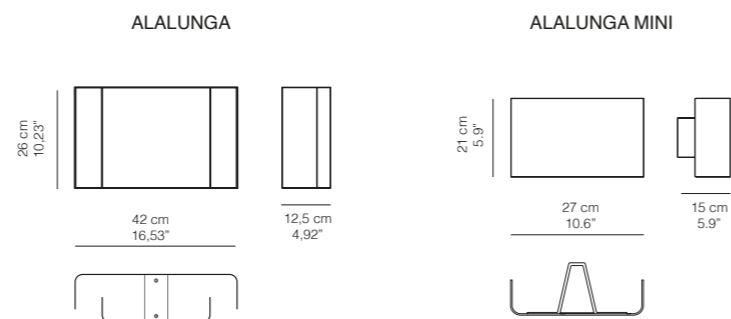

ALALUNGA / Design Enrico Franzolini

	Parete / Wall		SORGENTI LUMINOSE / LIGHT SOURCES		CERTIFICATIONS
	MISURE / DIMENSIONS		FLUO	LED	
	CM.	INCHES			
ALALUNGA					
18PA42FW	42 x 12,5 x 26H	16,53 x 4,92 x 10,23H	2 x 20W E27	2 x 10W E27	
18PA42FB	42 x 12,5 x 26H	16,53 x 4,92 x 10,23H	2 x 20W E27	2 x 10W E27	
			LED NON INCLUSO / LED NOT INCLUDED		
18PA42LW	42 x 12,5 x 26H	16,53 x 4,92 x 10,23H		12W - Lumen 1300 - 3000K	
18PA42LB	42 x 12,5 x 26H	16,53 x 4,92 x 10,23H		12W - Lumen 1300 - 3000K	
			LED INCLUSO / LED INCLUDED		
ALALUNGA MINI					
18PA01LR	20 x 8,2 x 12H	7,87 x 3,23 x 4,72H		2X4,5W - Lumen 720 - 2700K	
18PA01LW	20 x 8,2 x 12H	7,87 x 3,23 x 4,72H		2X4,5W - Lumen 720 - 2700K	Dimmer a taglio di fase AC phase-cut dimming
			LED INCLUSO / LED INCLUDED		
	COLORI / COLOURS				
18PA42LW - 18PA42FW	Metallo verniciato Bianco / White painted metal				
18PA42LB - 18PA42FB	Metallo - Bronzo spazzolato / Metal - brushed bronze finish				
18PA01LW	Metallo verniciato Bianco / White painted metal				
18PA01LR	Metallo - Rame Grezzo Satinato / Metal - Brushed copper finish				

LED

18PA42LW - 18PA42FW
18PA01LW



18PA42LB - 18PA42FB
18PA01LR

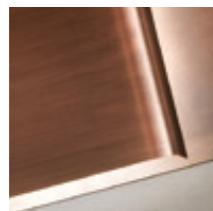

18PA01LR

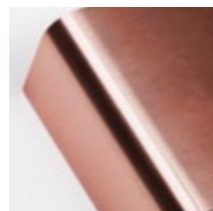

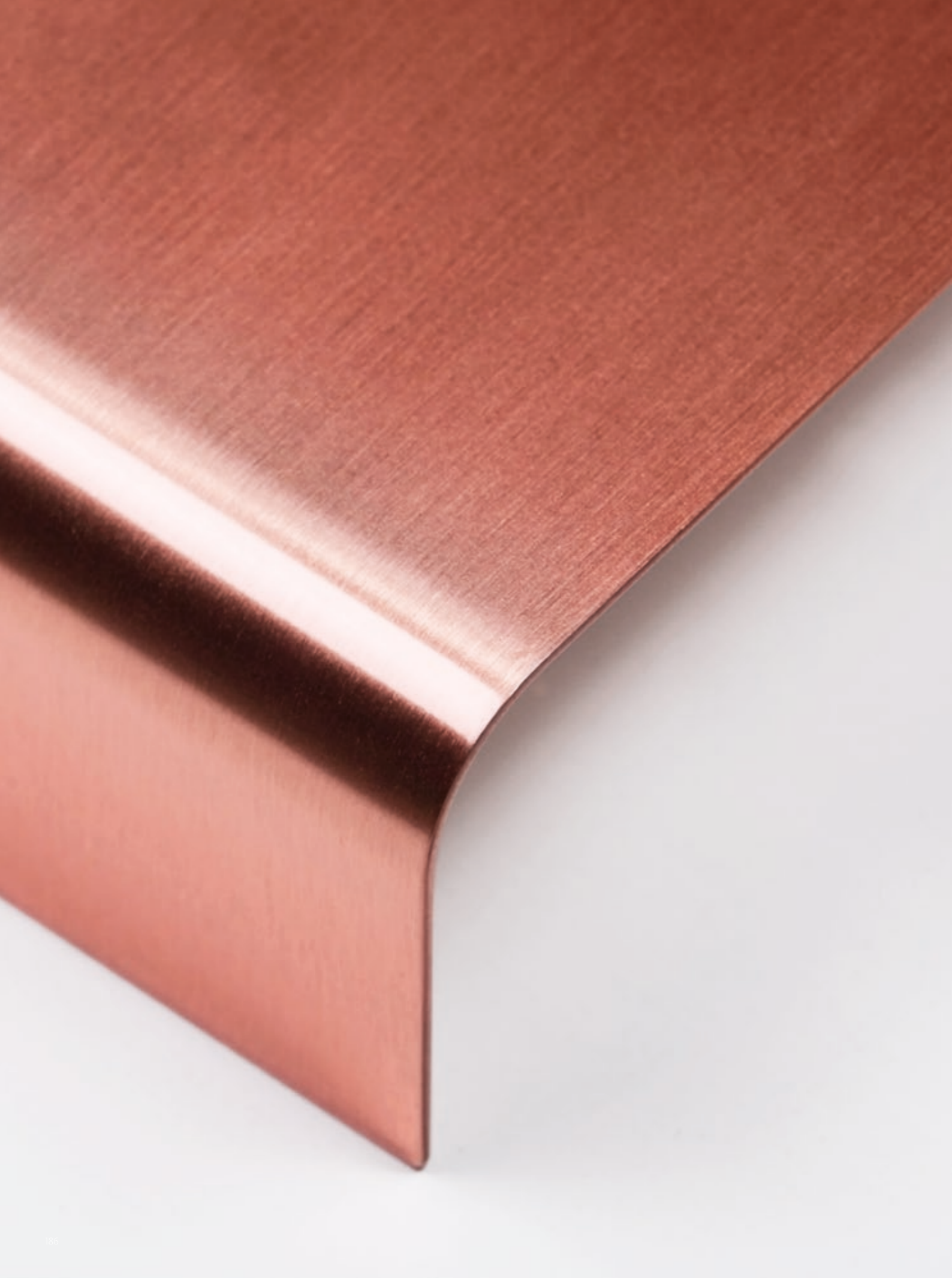

SHADOW /

Design Enrico Franzolini

Uno schermo in metallo che diffonde la luce in parete senza abbagliare. Luce ed ombra variamente modulabili con un semplice gesto.

A screen in metal that diffuses the light on the wall without dazzling. Light and shadow easily adjustable with a simple action.



Lampada da parete in metallo, verniciato bianco con diffusore orientabile.
Sorgente LED integrata dimmerabile taglio di fase.

Wall-mounted lamp with adjustable screen in white metal.
Integrated cut-phase dimmable LED source.

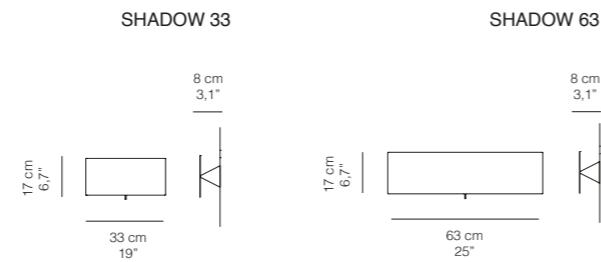

SHADOW / Design Enrico Franzolini

SHADOW	Parete / Wall		SORGENTI LUMINOSE / LIGHT SOURCES	
	MISURE / DIMENSIONS			
	CM.	INCHES	LED	
SHADOW 33				
11PA03LW	33 x 8 x 17H	13 x 3,1 x 6,7H	16W Lumen 1600 - 2700K	Dimmer a taglio di fase AC phase-cut dimming
			LED INCLUSO / LED INCLUDED	
SHADOW 63				
11PA06LW	63 x 8 x 17H	25 x 3,1 x 6,7H	24W Lumen 2400 - 2700K	Dimmer a taglio di fase AC phase-cut dimming
			LED INCLUSO / LED INCLUDED	
	COLORI / COLOURS		CERTIFICATIONS	
	Metallo Bianco / White metal			



ADD /

Design Thomas Feichtner

La ceramica modellata a mano, un foro dove far passare la lampadina, il colore. Questa è Add, la tradizione di forme e materiali che si uniscono ad una lampadina. Un insieme di colori per arredare ed illuminare gli spazi della vita quotidiana, un grappolo colorato, classico e moderno allo stesso tempo.

Hand crafted pottery, a slot for the light bulb, colour. This is Add, the tradition of shapes and materials that join up with a light bulb. A mix of colours to furnish and illuminate our living space, a coloured bunch, classical and modern at the same time.







Paralume in ceramica con l'interno sempre di colore bianco; all'esterno smalto colorato lucido in diversi colori. Solo la finitura "argilla" è opaca. Altri colori su richiesta.

Pottery lightshade coloured white on the inside; outside in glossy enamel in several colours. Only the clay finish is matt. Other colours on request.

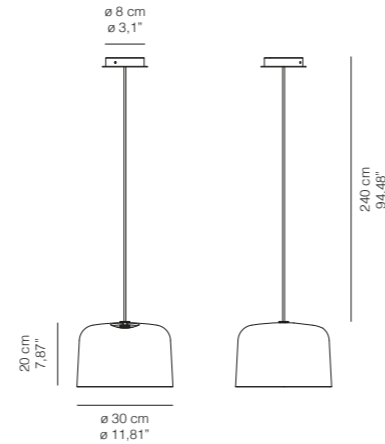

ADD / Designer Thomas Feichtner

ADD	Sospensione / Pendant		SORGENTI LUMINOSE / LIGHT SOURCES		CERTIFICATIONS
	MISURE / DIMENSIONS		FLUO	LED	
	CM.	INCHES			
	30ø x 20H	11,81ø x 7,87H	1x23W E27	1x10W E27	
COLORI / COLOURS					
15SP30F2	Ceramica smalto lucido Bianco - Pottery glossy White				CE IP 20
15SP30F5	Ceramica smalto lucido Arancio - Pottery glossy Orange				
15SP30F7	Ceramica smalto lucido Verde - Pottery glossy Green				
15SP30F8	Ceramica smalto lucido Blu - Pottery glossy Blue				
15SP30F9	Ceramica finitura Argilla opaca - Pottery in matt clay finish				
15SP30F4	Ceramica smalto lucido Bronzo / Pottery glossy Bronze				
OPZIONI / OPTIONS					
5MT	Sospensione cablaggio lunghezza cavi mt. 5,00 / Pendant with longer cables mt. 5,00				



SVEVA /

Design Massimiliano Mornati

Sveva, un'interpretazione contemporanea della lampada a sospensione, un'installazione luminosa dal segno deciso che dà forma all'immaterialità della luce.

Due lame lievemente piegate e contrapposte accolgono la sorgente luminosa e rivelano paesaggi inediti di luci e ombre. Traslucida con luce diffusa, nella versione in metacrilato satinato, fortemente grafica quella in metallo verniciato.

Sveva, a contemporary interpretation of a pendant lamp, a luminous installation with a strong impact gives shape to immaterial light.

Two slightly bent opposing blades cradle the light source and reveal unusual landscapes of light and shade. Translucent with diffuse reflection in the brushed methacrylate version, decidedly graphic in the painted metal version.





Lampada da sospensione con sorgente LED diretta ed indiretta. I diffusori sono in metacrilato opalino per una luce diffusa oppure in metallo verniciato bianco opaco per luce diretta ed indiretta.

Pendant lamp with direct and indirect LED light source. The shades are in opaline methacrylate for diffuse reflection or matt white painted metal for direct and indirect light.

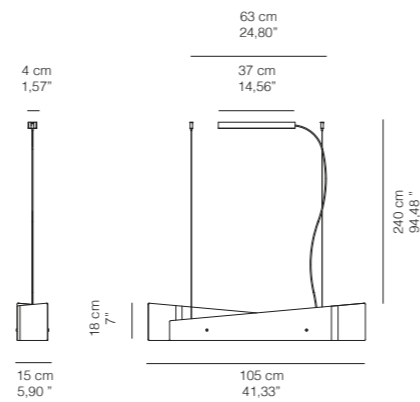

SVEVA / Design Massimiliano Mornati

SVEVA	Sospensione / Pendant		SORGENTI LUMINOSE / LIGHT SOURCES	
	MISURE / DIMENSIONS		LED.	
	CM.	INCHES		
	105 x 15-18H	41,33 x 5,90-7,08H	36W LUMEN 4000 3000K	
			LED INCLUSO / LED INCLUDED	
	COLORI / COLOURS			
16SP11LM (MW)	Metacrilato bianco opalino / White opaline methacrylate		(MW) Dimmer DALI	
16SP11LW (MW)	Metallo verniciato bianco / White painted metal		(MW) Dimmer DALI	
	OPZIONI / OPTIONS		CERTIFICATIONS	
5MT	Sospensione cablaggio lunghezza cavi mt. 5,00 / Pendant with longer cables mt. 5,00		IP 20	

LED

16SP11LM



16SP11LW



GOUT /

Design Enrico Franzolini

Un calice in vetro soffiato.

Un fiore che sboccia con il suo gambo.

Un pensiero delicato, fluido, elegante.

Lampada da sospensione che produce un'emissione di luce diretta e diffusa.

Il diffusore, prodotto in vetro soffiato a bocca, è disponibile nei colori bianco oppure nero.

A chalice in hand blown glass.

A flower with its stem, that blooms.

A delicate, fluid and elegant thought.

Suspension lamp providing direct and diffused light emission.

The diffuser in blown glass is available in white or black color.



Lampada a sospensione con diffusore in vetro soffiato a bocca disponibile in colore bianco o nero. Asta e rosone in metallo verniciato nero.

Suspension lamp providing direct and diffused light emission. The diffuser in blown glass is available in white or black color. The stem, ceiling rose and cable in black color.

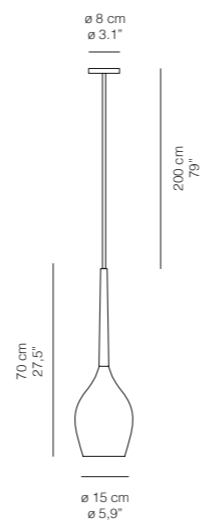

GOUT / Design Enrico Franzolini

GOUT		Sospensione / Pendant		SORGENTI LUMINOSE / LIGHT SOURCES		CERTIFICATIONS	
MISURE / DIMENSIONS							
CM.	INCHES			FLUO	LED		
15Ø x 70-200H	5,9Ø x 27,5-79H			1x20W E27	1x10W E27		
COLORI / COLOURS							
14SPWH01	Vetro Bianco / White Glass						
14SPBK02	Vetro Nero / Black Glass						
OPZIONI / OPTIONS							
5MT	Sospensione cablaggio lunghezza cavi mt. 5,00 / Pendant with longer cables mt. 5,00						



14SPWH01



14SPBK02

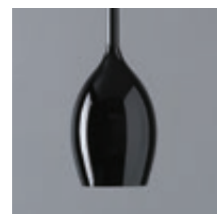

SUN /

Design Brian Rasmussen

Sun tratta il tema della luce sulla superficie della lampada: il tema del chiaro-scuro. Le aperture sul paralume permettono alla luce di giocare, riflettersi, di sottolinearne la forma sferica creando una serie di esplosioni luminose proprio come il sole...

Il paralume è disponibile in un elegante tessuto nei colori bianco, rosso e nero. La collezione comprende le versioni sospensione, tavolo con diametro 50 cm, mentre il diametro più grande – 75 cm – è disponibile nel modello sospensione.

Sun explores the theme of light on the surface of the lamp: the theme of brightness and shadow. The slits on the shade allow the light to dance, glimmer and underscore the spherical shape creating a series of luminous explosions just like the sun itself...

The shade is available in an elegant textile fabric in white, red and black. Sun collection is hanging, table and pendant 50 cm diameter.

The hanging version also in 75 cm diameter.



Lampada da sospensione costruita incastrando 96 volte sottilissimi fogli di tessuto bianco, rosso, nero. Rosone in metallo verniciato nero.

Pendant lamp made by slotting together 96 times very thin sheets of white, red, black textile fabric. Support in black-painted metal.

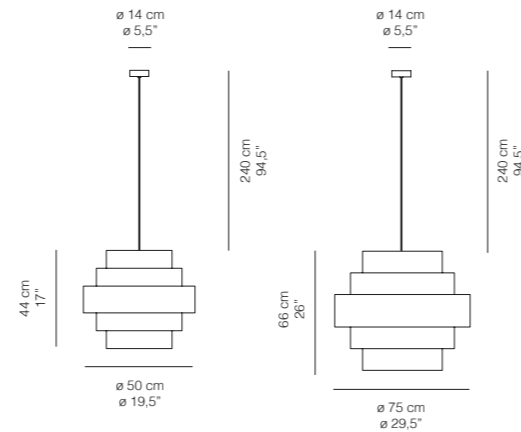

SUN / Design Brian Rasmussen

Sospensione / Pendant		SORGENTI LUMINOSE / LIGHT SOURCES		CERTIFICATIONS	
MISURE / DIMENSIONS					
CM.	INCHES	FLUO	LED		
SUN 50	50ø x 44-240H	19,5ø x 17-94,5H	1x40W E27	1x16W E27	
SUN 75	75ø x 66-240H	29,5ø x 26-94,5H	3x20W E27	3x10W E27	
SUN 50		SUN 75		CERTIFICATIONS	
05SPWH50S		05SPWH75S			
05SPRD50S		05SPRD75S			
05SPBK50S		05SPBK75S			
COLORI / COLOURS		OPZIONI / OPTIONS			
Tessuto Bianco / White Textile fabric		Sospensione cablaggio lunghezza cavi mt. 5,00 / Pendant with longer cables mt. 5,00			
Tessuto Rosso / Red Textile fabric					
Tessuto Nero / Black Textile fabric					



05SPWH50S
05SPWH75S



05SPBK50S
05SPBK75S



05SPRD50S
05SPRD75S

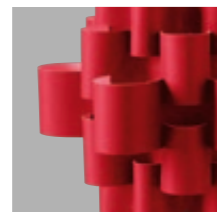



Lampada da tavolo costruita incastrando 96 volte sottilissimi fogli di tessuto bianco, rosso, nero. Base in metallo verniciata grigio chiaro.

Table lamp made by slotting together 96 times very thin sheets of white, red, black textile fabric. Base in metal painted light grey.

Sun/ Tavolo / Table

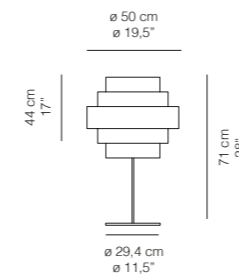

SUN / Design Brian Rasmussen

SUN		Tavolo / Table		SORGENTI LUMINOSE / LIGHT SOURCES		CERTIFICATIONS	
MISURE / DIMENSIONS		MISURE / DIMENSIONS		FLUO		LED	
CM.	INCHES	FLUO	LED	dimmer			
50ø x 44-71H	19,5ø x 17-28H	1x40W E27	1x16W E27			CERTIFICATIONS	
COLORI / COLOURS							
05TVWH50S	Tessuto Bianco / White Textile fabric						
05TVRD50S	Tessuto Rosso / Red Textile fabric						
05TVBK50S	Tessuto Nero / Black Textile fabric						

05TVWH50S 05TVBK50S 05TVRD50S

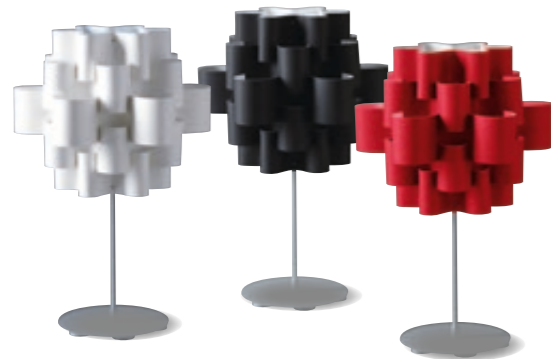

DRINK /

Design Enrico Franzolini with Vicente Garcia Jimenez

Collezione composta da lampade da terra e soffitto, in fibra di carbonio o in composito di fibra di vetro verniciata nera orientabile a 360° e inclinabile di 15°.

La versione soffitto è disponibile nella versione monocono o bicono, in tre misure d'altezza, 63 cm, 127 cm o 175 cm.

A collection composed of floor, ceiling and pendant lamps in black carbon fibres with metal base painted black or in painted composite fibreglass, pivots 360° and angle of tilt 15°.

The pendant version is available with a single or twin cones in three different lengths of 63 cm, 127 cm and 175 cm.



Lampada da soffitto orientabile a 360° e inclinabile di 15°. Cono in fibra di carbonio o in composito di fibra di vetro verniciata. Disponibile nelle lunghezze di cm 63, 127 oppure cm 175. Base in metallo.

Ceiling lamp that can pivot 360° and tilt angle 15°. Cone in carbon fibre or in painted composite fibreglass. Available length 63, 127 or cm 175. Metal base.

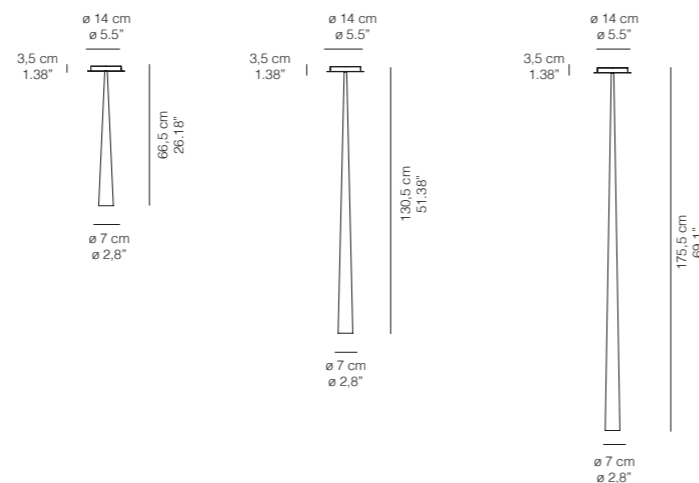

DRINK / Design Enrico Franzolini with Vicente Garcia Jimenez

Soffitto / Ceiling		SORGENTI LUMINOSE / LIGHT SOURCES		CERTIFICATIONS	
MISURE / DIMENSIONS		LED		CE IP 20	
CM.	INCHES	LED		CE IP 20	
DRINK 63	7-14ø x 63H	2,8-5,5ø x 24.8 H	1X8,7W - Lumen 800 - 2700K		
DRINK 127	7-14ø x 127H	2,8-5,5ø x 50H	1X8,7W - Lumen 800 - 2700K		
DRINK 175	7-14ø x 175H	2,8-5,5ø x 69H	1X8,7W - Lumen 800 - 2700K		
		LED INCLUSO / LED INCLUDED		CERTIFICATIONS	
DRINK 63	COLORI / COLOURS			CE IP 20	
04SF06301	Fibra di carbonio / Carbon fibre			CE IP 20	
04SF0630+2/3/5/6	Fibra di vetro / Fibreglass: Bianco / White (2) - Rosso / Red (3) - Arancio / Orange (5) - Argento / Silver (6)			CE IP 20	
DRINK 127	COLORI / COLOURS			CERTIFICATIONS	
04SF12701	Fibra di carbonio / Carbon fibre			CE IP 20	
04SF1270+2/3/5/6	Fibra di vetro / Fibreglass: Bianco / White (2) - Rosso / Red (3) - Arancio / Orange (5) - Argento / Silver (6)			CERTIFICATIONS	
DRINK 175	COLORI / COLOURS			CERTIFICATIONS	
04SF17501	Fibra di carbonio / Carbon fibre			CE IP 20	
04SF1750+2/3/5/6	Fibra di vetro / Fibreglass: Bianco / White (2) - Rosso / Red (3) - Arancio / Orange (5) - Argento / Silver (6)			CERTIFICATIONS	

LED

04SF06302 04SF06303 04SF06305 04SF06306 04SF06301
 04SP12702 04SP12703 04SP12705 04SP12706 04SP12701
 04SP17502 04SP17503 04SP17505 04SP17506 04SP17501



Drink 63-127-175 / Soffitto / Ceiling

Lampada da incasso orientabile a 360° e inclinabile di 15°. Cono in fibra di carbonio o in composito di fibra di vetro verniciata. Disponibile nelle lunghezze di cm 63, 127 oppure cm 175. Base in metallo.

Recessed lamp that can pivot 360° and tilt angle 15°. Cone in carbon fibre or in painted composite fibreglass. Available length 63, 127 or cm 175. Metal base.

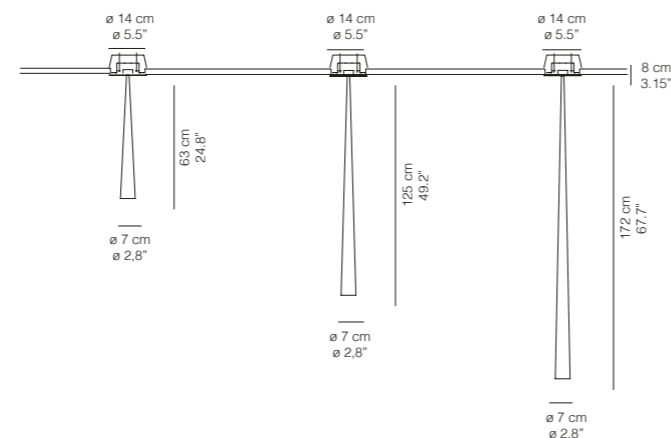

DRINK / Design Enrico Franzolini with Vicente Garcia Jimenez

	Incasso / Recessed	SORGENTI LUMINOSE / LIGHT SOURCES	
	MISURE / DIMENSIONS	LED	
	CM. INCHES		
DRINK 63	7-14ø x 63H 2,8-5.5ø x 24.8 H	1X8,7W - Lumen 800 - 2700K	
DRINK 127	7-14ø x 127H 2,8-5.5ø x 50H	1X8,7W - Lumen 800 - 2700K	
DRINK 175	7-14ø x 175H 2,8-5.5ø x 69H	1X8,7W - Lumen 800 - 2700K	
	LED INCLUSO / LED INCLUDED	COLORI / COLOURS	CERTIFICATIONS
DRINK 63	04NC06301 04NC0630+2/3/5/6	Fibra di carbonio / Carbon fibre Fibra di vetro / Fibreglass: Bianco / White (2) - Rosso / Red (3) - Arancio / Orange (5) - Argento / Silver (6)	CE IP 20
DRINK 127	04NC12701 04NC1270+2/3/5/6	Fibra di carbonio / Carbon fibre Fibra di vetro / Fibreglass: Bianco / White (2) - Rosso / Red (3) - Arancio / Orange (5) - Argento / Silver (6)	CE IP 20
DRINK 175	04NC17501 04NC1750+2/3/5/6	Fibra di carbonio / Carbon fibre Fibra di vetro / Fibreglass: Bianco / White (2) - Rosso / Red (3) - Arancio / Orange (5) - Argento / Silver (6)	CE IP 20

LED

04NC06302
04NC12702
04NC17502

04NC06303
04NC12703
04NC17503

04NC06305
04NC12705
04NC17505

04NC06306
04NC12706
04NC17506

04NC06301
04NC12701
04NC17501



Drink 63-127-175 / Soffitto / Ceiling

DRINK /

Design Enrico Franzolini
with Vicente Garcia Jimenez



Lampada da soffitto orientabile a 360° e inclinabile di 15°. Cono in fibra di carbonio o in composito di fibra di vetro verniciata, disponibile nella lunghezze di cm 63, 127 oppure cm 175.

Ceiling lamp that can pivot 360° and tilt angle 15°. Cone in carbon fibre or in painted composite fibreglass length available cm 63, 127 or cm 175. Base in painted metal.

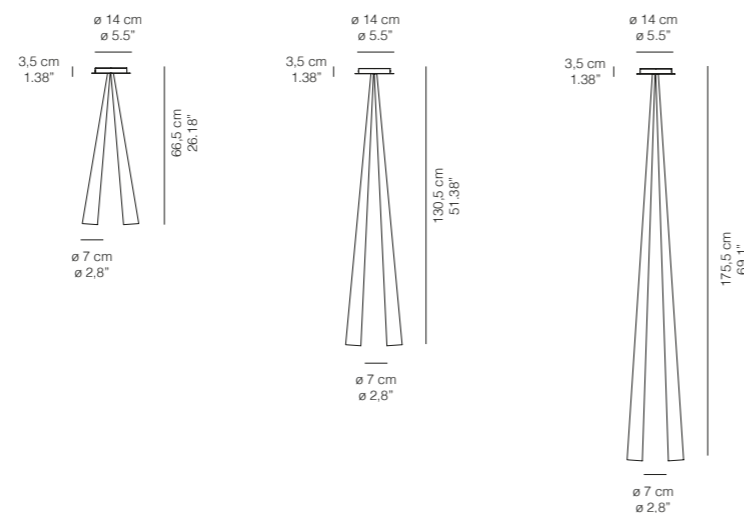

DRINK bicono / Design Enrico Franzolini with Vicente Garcia Jimenez

	Soffitto / Ceiling		SORGENTI LUMINOSE / LIGHT SOURCES		
	MISURE / DIMENSIONS				
	CM.	INCHES	LED		
DRINK 63 BICONO	7-14ø x 63H	2,8-5,5ø x 24.8 H	2X8,7W - Lumen 800 - 2700K		
DRINK 127 BICONO	7-14ø x 127H	2,8-5,5ø x 50H	2X8,7W - Lumen 800 - 2700K		
DRINK 175 BICONO	7-14ø x 175H	2,8-5,5ø x 69H	2X8,7W - Lumen 800 - 2700K		
	Soffitto / Ceiling		LED INCLUSO / LED INCLUDED		
	COLORI / COLOURS				CERTIFICATIONS
DRINK 63 BICONO	04SF06301B		Fibra di carbonio / Carbon fibre		CE IP 20
	04SF0630+2/3/5/6/B		Fibra di vetro / Fibreglass: Bianco / White (2) - Rosso / Red (3) - Arancio / Orange (5) - Argento / Silver (6)		
	Soffitto / Ceiling		COLORI / COLOURS		CERTIFICATIONS
DRINK 127 BICONO	04SF12701/B		Fibra di carbonio / Carbon fibre		CE IP 20
	04SF1270+2/3/5/6/B		Fibra di vetro / Fibreglass: Bianco / White (2) - Rosso / Red (3) - Arancio / Orange (5) - Argento / Silver (6)		
	Soffitto / Ceiling		COLORI / COLOURS		CERTIFICATIONS
DRINK 175 BICONO	04SF17501/B		Fibra di carbonio / Carbon fibre		CE IP 20
	04SF1750+2/3/5/6		Fibra di vetro / Fibreglass: Bianco / White (2) - Rosso / Red (3) - Arancio / Orange (5) - Argento / Silver (6)		

LED

04SF06302/B 04SF06303/B 04SF06305/B 04SF06306/B 04SF06301/B
 04SP12702/B 04SP12703/B 04SP12705/B 04SP12706/B 04SP 12701/B
 04SP17502/B 04SP17503/B 04SP17505/B 04SP17506/B 04SP17501/B

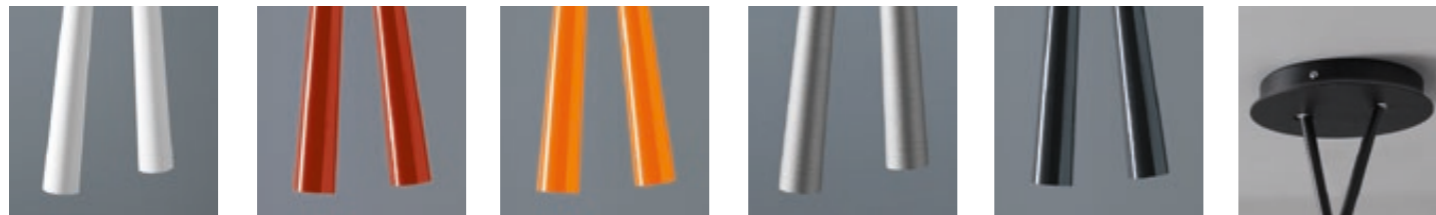

Drink 63-127-175 Bicono / Soffitto / Ceiling

Lampada da incasso orientabile a 360° e inclinabile di 15°. Cono in fibra di carbonio o in composito di fibra di vetro verniciata. Disponibile nelle lunghezze di cm 63, 127 oppure cm 175. Base in metallo.

Recessed lamp that can pivot 360° and tilt angle 15°. Cone in carbon fibre or in painted composite fibreglass. Available length 63, 127 or cm 175. Metal base.

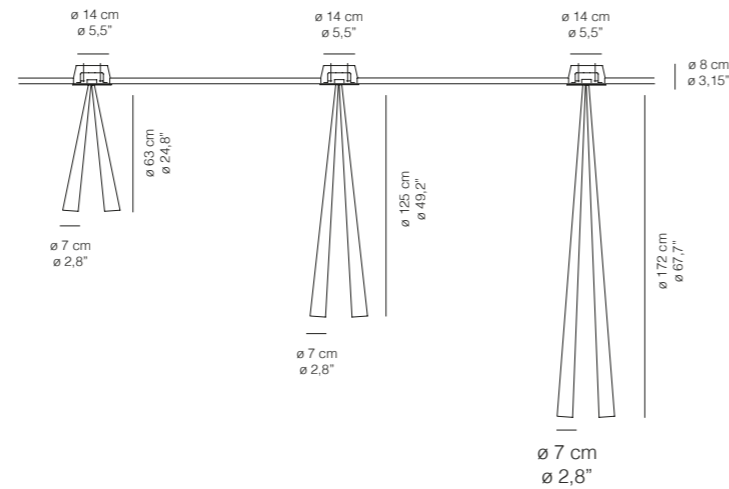

DRINK bicono / Design Enrico Franzolini with Vicente Garcia Jimenez

	Incasso / Recessed		SORGENTI LUMINOSE / LIGHT SOURCES		
	MISURE / DIMENSIONS				
	CM.	INCHES	LED		
DRINK 63 BICONO	7-14ø x 63H	2,8-5,5ø x 24,8H	2X8,7W - Lumen 800 - 2700K		
DRINK 127 BICONO	7-14ø x 127H	2,8-5,5ø x 50H	2X8,7W - Lumen 800 - 2700K		
DRINK 175 BICONO	7-14ø x 175H	2,8-5,5ø x 69H	2X8,7W - Lumen 800 - 2700K		
			LED INCLUSO / LED INCLUDED		
DRINK 63 BICONO	Incasso / recessed		COLORI / COLOURS		CERTIFICATIONS
	04NC06301/B		Fibra di carbonio / Carbon fibre		∇ CE IP 20
	04NC0630+2/3/5/6/B		Fibra di vetro / Fibreglass: Bianco / White (2) - Rosso / Red (3) - Arancio / Orange (5) - Argento / Silver (6)		
DRINK 127 BICONO	Incasso / recessed		COLORI / COLOURS		CERTIFICATIONS
	04NC12701/B		Fibra di carbonio / Carbon fibre		∇ CE IP 20
	04NC1270+2/3/5/6/B		Fibra di vetro / Fibreglass: Bianco / White (2) - Rosso / Red (3) - Arancio / Orange (5) - Argento / Silver (6)		
DRINK 175 BICONO	Incasso / recessed		COLORI / COLOURS		CERTIFICATIONS
	04NC17501/B		Fibra di carbonio / Carbon fibre		∇ CE IP 20
	04NC1750+2/3/5/6/B		Fibra di vetro / Fibreglass: Bianco / White (2) - Rosso / Red (3) - Arancio / Orange (5) - Argento / Silver (6)		

LED

04NC06302/B 04NC06303/B 04NC06305/B 04NC06306/B 04NC06301/B
 04NC12702/B 04NC12703/B 04NC12705/B 04NC12706/B 04NC12701/B
 04NC17502/B 04NC17503/B 04NC17505/B 04NC17506/B 04NC17501/B

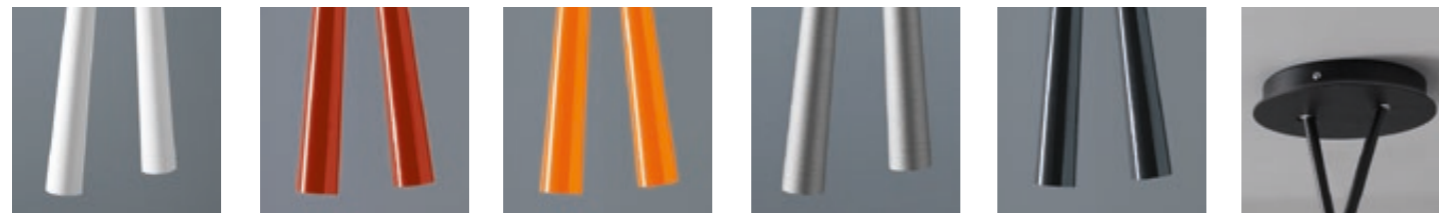

Drink 63-127-175 Bicono / Soffitto / Ceiling

Lampada a sospensione realizzata in fibra di carbonio oppure in composito di fibra di vetro verniciato.
Su richiesta disponibile in tutti i colori.

Pendant lamp in carbon fibre or in composite Fibreglass painted.
On request, any color available.

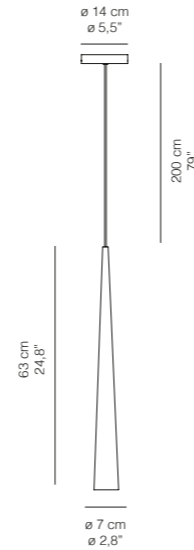

DRINK 63 / Design Enrico Franzolini with Vicente Garcia Jimenez

DRINK 63	Sospensione / Pendant		
	MISURE / DIMENSIONS		SORGENTI LUMINOSE / LIGHT SOURCES
	CM.	INCHES	LED
	7-14ø x 63H	2,8-5,5ø x 24,8H	1x8,7W - Lumen 800 - 2700K LED INCLUSO / LED INCLUDED
	COLORI / COLOURS		CERTIFICATIONS
04SP6301	Fibra di carbonio / Carbonfibre		IP 20
04SP6302	Fibra di vetro bianca / White fibreglass		
04SP6303	Fibra di vetro rossa / Red fibreglass		
04SP6305	Fibra di vetro arancio / Orange fibreglass		
04SP6306	Fibra di vetro argento / Silver fibreglass		
	OPZIONI / OPTIONS		
	Rosone a incasso / Canopy		

LED

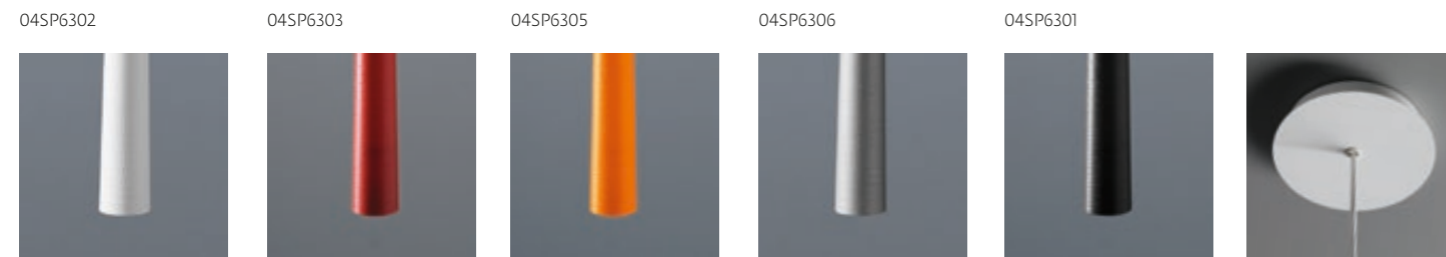

Drink 63 / Sospensione / Pendant



Lampada da terra orientabile a 360° e inclinabile di 15°. Cono in fibra di carbonio o in composito di fibra di vetro verniciata e base in metallo verniciato nero.

Floor lamp that can pivot 360° and tilt angle 15° cone in carbon fibre or in painted composite fibreglass and base in black-painted metal.

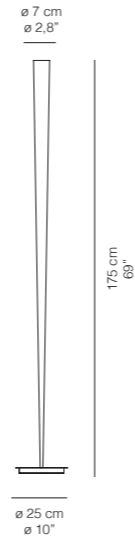

DRINK / Design Enrico Franzolini with Vicente Garcia Jimenez

DRINK	Terra / Floor		SORGENTI LUMINOSE / LIGHT SOURCES	
	MISURE / DIMENSIONS			
	CM.	INCHES	LED	
	7-25ø x 175H	2,8-10ø x 69H	1x8,7W - Lumen 800 - 2700K LED INCLUSO / LED INCLUDED	
	COLORI / COLOURS		CERTIFICATIONS	
04TR17511	Fibra di vetro bianca / White fibreglass		V IP 20	
04TR17512	Fibra di carbonio / Carbonfibre			
04TR17516	Fibra di vetro rossa / Red fibreglass			
04TR17523	Fibra di vetro arancio / Orange fibreglass			
04TR17525	Fibra di vetro argento / Silver fibreglass			

LED

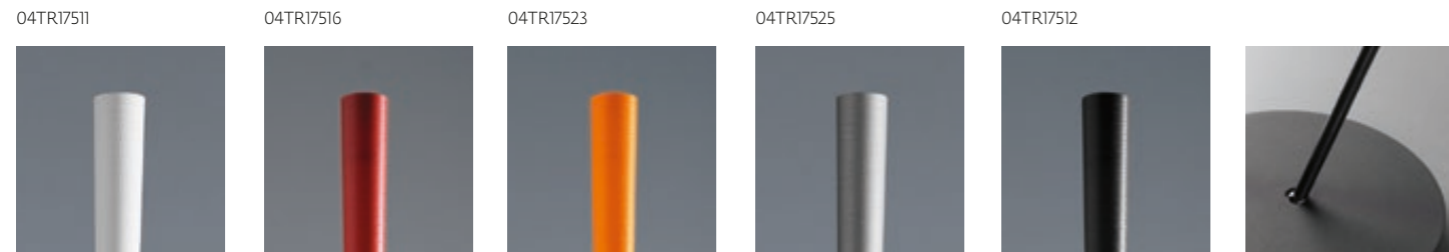

Drink / Terra / Floor



SLICE /

Design Enrico Franzolini with Vicente Garcia Jimenez

Collezione composta da lampade a sospensione, parete e soffitto, disponibili in diversi diametri e lunghezze.

I cilindri sono realizzati in fibra di carbonio o in composito di fibra di vetro verniciata con taglio obliquo ed interno colorato.

Collection made up of hanging, wall and ceiling lamps, available in various diameters and lengths.

The cylinders are in carbon fibre or in painted composite fibreglass with oblique cut and colorful interior.



Lampada a sospensione realizzata in fibra di carbonio oppure in composito di fibra di vetro verniciato. Su richiesta disponibile in tutti i colori.

Pendant lamp in carbon fibre or in composite Fibreglass painted. On request, any color available.

02SP0302-G
02SP0402-G
02SP0702-G



Special Gold Edition (G)

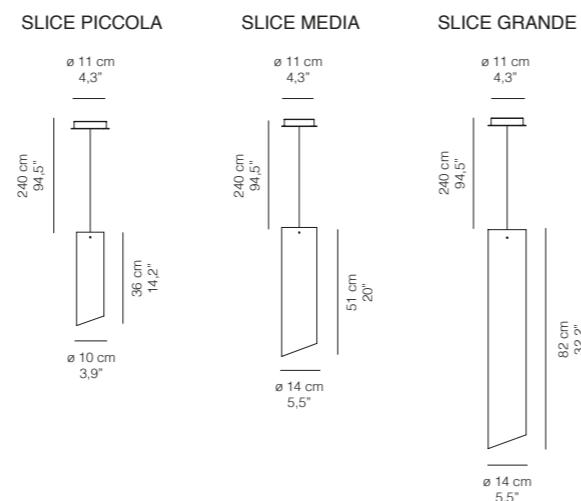

SLICE / Design Enrico Franzolini with Vicente Garcia Jimenez

Sospensione / Pendant		SORGENTI LUMINOSE / LIGHT SOURCES			
MISURE / DIMENSIONS		HALOG.	LED	FLUO	
CM.	INCHES				
SLICE Piccola	10ø x 36-240H	3,9ø x 14,2-94,5HH	max 1x75W E27 PAR 30S	1x11W 230V E27 PAR 30S	
SLICE Media	14ø x 51-240H	5,5ø x 20-94,5HH	max 1x100W E27 PAR 38	1x16W E27 PAR 38	1x23W E27 PAR 38
SLICE Grande	14ø x 82-240H	5,5ø x 32,2-94,5HH	max 1x100W E27 PAR 38	1x16W E27 PAR 38	1x23W E27 PAR 38
SLICE Piccola	COLORI / COLOURS				CERTIFICATIONS
02SP0301-(Y-R-O)	Fibra di carbonio / Carbon fibre - Interno giallo/yellow inside (Y) - Interno rosso / red inside (R) - Interno arancio / orange inside (O)				CE IP 20
02SP0302-(Y-R-O)	Fibra di vetro bianco / White Fibreglass - Interno giallo / yellow inside (Y) - Interno rosso / red inside (R) - Interno arancio / orange inside (O)				
02SP0302-G	Fibra di vetro oro / Gold Fibreglass - Interno oro / Gold inside				
SLICE Media	COLORI / COLOURS				CERTIFICATIONS
02SP0401-(Y-R-O)	Fibra di carbonio / Carbon fibre - Interno giallo / yellow inside (Y) - Interno rosso / red inside (R) - Interno arancio / orange inside (O)				CE IP 20
02SP0402-(Y-R-O)	Fibra di vetro bianco / White Fibreglass - Interno giallo / yellow inside (Y) - Interno rosso / red inside (R) - Interno arancio / orange inside (O)				
02SP0402-G	Fibra di vetro oro / Gold Fibreglass - Interno oro / Gold inside				
SLICE Grande	COLORI / COLOURS				CERTIFICATIONS
02SP0701-(Y-R-O)	Fibra di carbonio / Carbon fibre - Interno giallo / yellow inside (Y) - Interno rosso / red inside (R) - Interno arancio / orange inside (O)				CE IP 20
02SP0702-(Y-R-O)	Fibra di vetro bianco / White Fibreglass - Interno giallo / yellow inside (Y) - Interno rosso / red inside (R) - Interno arancio / orange inside (O)				
02SP0702-G	Fibra di vetro oro / Gold Fibreglass - Interno oro / Gold inside				
	OPZIONI / OPTIONS				
5MT	Sospensione cablaggio lunghezza cavi mt. 5,00 / Pendant with longer cables mt. 5,00				

02SP0302-R
02SP0402-R
02SP0702-R



02SP0302-O
02SP0402-O
02SP0702-O



02SP0302-Y
02SP0402-Y
02SP0702-Y



02SP0301-R
02SP0401-R
02SP0701-R



02SP0301-O
02SP0401-O
02SP0701-O



02SP0301-Y
02SP0401-Y
02SP0701-Y

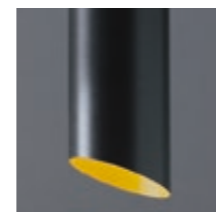

Slice Piccola / Media / Grande / Sospensione / Pendant



Lampada da soffitto realizzata in fibra di carbonio oppure in composito di fibra di vetro verniciato. Su richiesta disponibile in tutti i colori.

Ceiling lamp in carbon fibre or in composite Fibreglass painted. On request, any color available.

Slice Piccola / Media / Grande / Soffitto / Ceiling

02SF0302-G
02SF0402-G
02SF0702-G



Special Gold Edition (G)

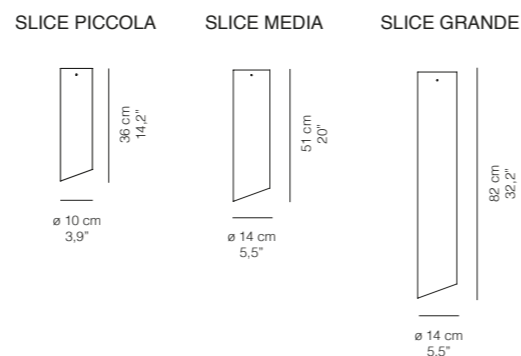

SLICE / Design Enrico Franzolini with Vicente Garcia Jimenez

Soffitto / Ceiling		SORGENTI LUMINOSE / LIGHT SOURCES			CERTIFICATIONS	
MISURE / DIMENSIONS		HALOG.	LED	FLUO		
CM.	INCHES	max 1x75W E27 PAR 30S	1x11W 230V E27 PAR 30S			
SLICE Piccola	10ø x 36H	3,9ø x 14,2H	max 1x100W E27 PAR 38	1x16W E27 PAR 38	1x23W E27 PAR 38	
SLICE Media	14ø x 51H	5,5ø x 20H	max 1x100W E27 PAR 38	1x16W E27 PAR 38	1x23W E27 PAR 38	
SLICE Grande	14ø x 82H	8,2ø x 32,2H	max 1x100W E27 PAR 38	1x16W E27 PAR 38	1x23W E27 PAR 38	
SLICE Piccola		COLORI / COLOURS			CERTIFICATIONS	
02SF0301-(Y-R-O)	Fibra di carbonio / Carbon fibre - Interno giallo/yellow inside (Y) - Interno rosso / red inside (R) - Interno arancio / orange inside (O)			□ ▽ CE IP 20		
02SF0302-(Y-R-O)	Fibra di vetro bianco / White Fibreglass - Interno giallo / yellow inside (Y) - Interno rosso / red inside (R) - Interno arancio / orange inside (O)					
02SF0302-G	Fibra di vetro oro / Gold Fibreglass- Interno oro / Gold inside					
SLICE Media		COLORI / COLOURS			CERTIFICATIONS	
02SF0401-(Y-R-O)	Fibra di carbonio / Carbon fibre - Interno giallo / yellow inside (Y) - Interno rosso / red inside (R) - Interno arancio / orange inside (O)			□ ▽ CE IP 20		
02SF0402-(Y-R-O)	Fibra di vetro bianco / White Fibreglass - Interno giallo / yellow inside (Y) - Interno rosso / red inside (R) - Interno arancio / orange inside (O)					
02SF0402-G	Fibra di vetro oro / Gold Fibreglass - Interno oro / Gold inside					
SLICE Grande		COLORI / COLOURS			CERTIFICATIONS	
02SF0701-(Y-R-O)	Fibra di carbonio / Carbon fibre - Interno giallo / yellow inside (Y) - Interno rosso / red inside (R) - Interno arancio / orange inside (O)			□ ▽ CE IP 20		
02SF0702-(Y-R-O)	Fibra di vetro bianco / White Fibreglass - Interno giallo / yellow inside (Y) - Interno rosso / red inside (R) - Interno arancio / orange inside (O)					
02SF0702-G	Fibra di vetro oro / Gold Fibreglass -Interno oro / Gold inside					

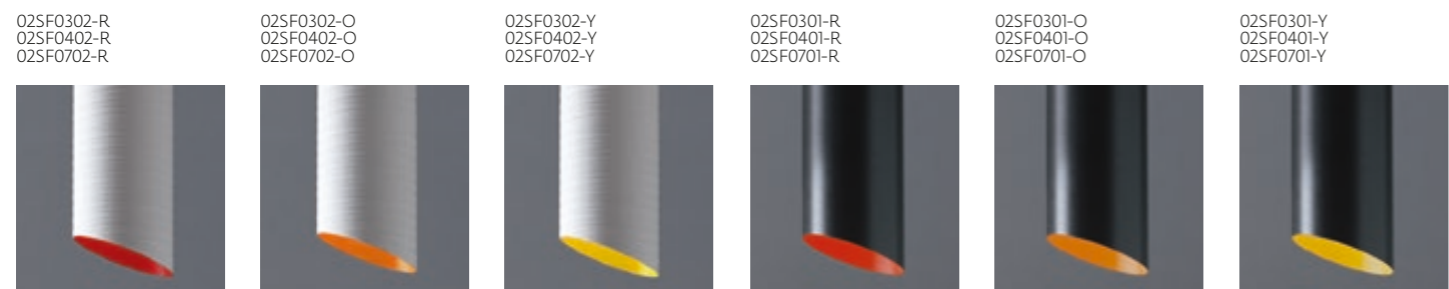
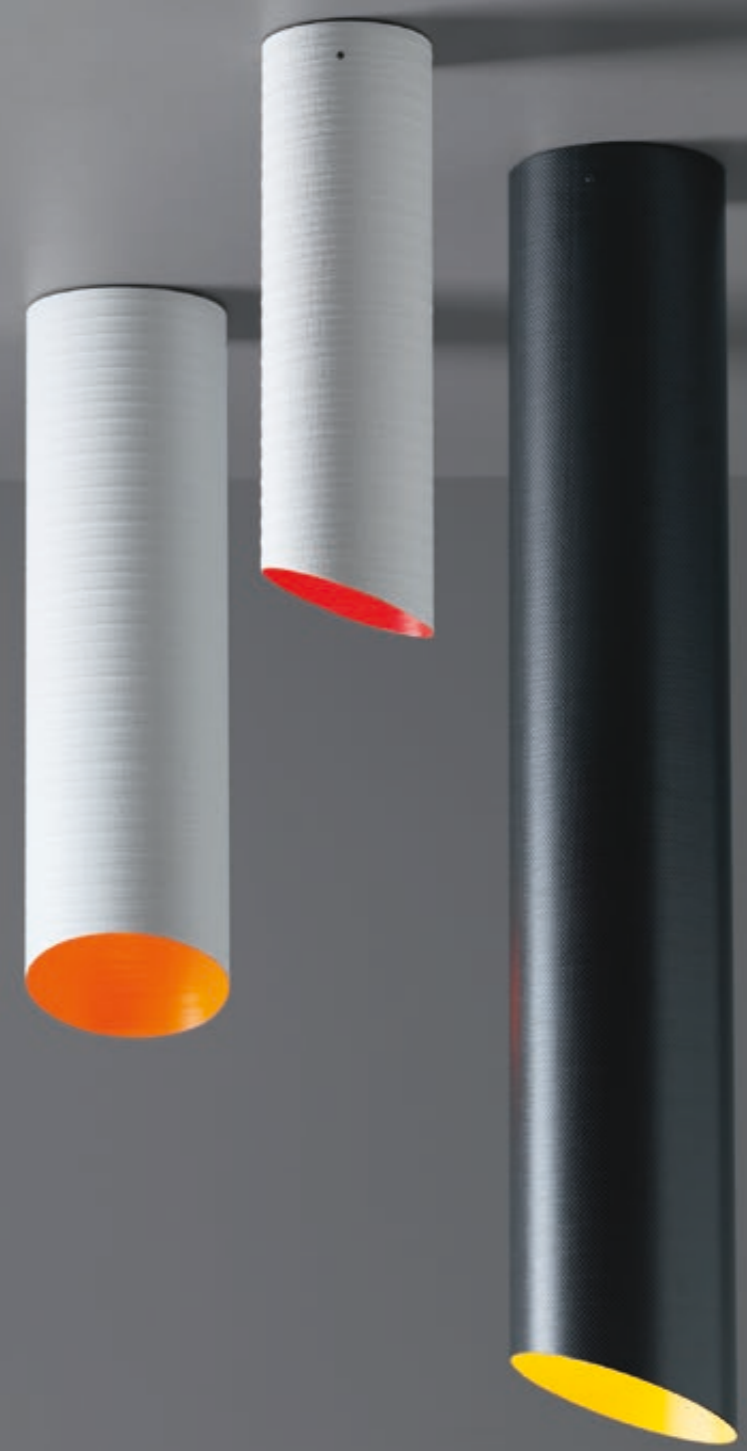



Lampada da tavolo realizzata in fibra di carbonio oppure in composito di fibra di vetro verniciato.

Su richiesta disponibile in tutti i colori.

Table lamp in carbon fibre or in composite Fibreglass painted. On request, any color available.

02AP0302-G
02AP0402-G
02AP0702-G



Special Gold Edition (G)

SLICE PICCOLA SLICE MEDIA SLICE GRANDE

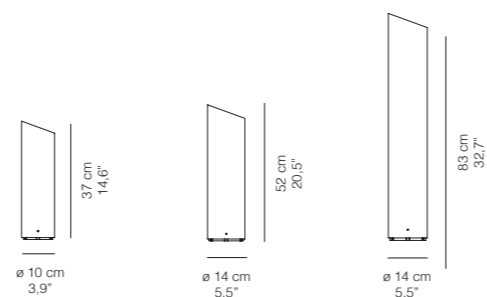

SLICE / Design Enrico Franzolini with Vicente Garcia Jimenez

Da appoggio/ Table desk		SORGENTI LUMINOSE / LIGHT SOURCES		
MISURE / DIMENSIONS				
CM.	INCHES	HALOG.	LED	FLUO
SLICE Piccola	10ø x 37H	3,9ø x 14,6H	max 1x75W E27 PAR 30S	1x11W 230V E27 PAR 30S
SLICE Media	14ø x 52H	5,5ø x 20,5H	max 1x100W E27 PAR 38	1x16W E27 PAR 38 1x23W E27 PAR 38
SLICE Grande	14ø x 83H	8,2ø x 32,7H	max 1x100W E27 PAR 38	1x16W E27 PAR 38 1x23W E27 PAR 38
SLICE Piccola	COLORI / COLOURS			
02AP0301-(Y-R-O)	Fibra di carbonio / Carbon fibre - Interno giallo/yellow inside (Y) - Interno rosso / red inside (R) - Interno arancio / orange inside (O)			
02AP0302-(Y-R-O)	Fibra di vetro bianco / White Fibreglass - Interno giallo / yellow inside (Y) - Interno rosso / red inside (R) - Interno arancio / orange inside (O)			
02AP0302-G	Fibra di vetro oro / Gold Fibreglass- Interno oro / Gold inside			
SLICE Media	COLORI / COLOURS			
02AP0401-(Y-R-O)	Fibra di carbonio / Carbon fibre - Interno giallo / yellow inside (Y) - Interno rosso / red inside (R) - Interno arancio / orange inside (O)			
02AP0402-(Y-R-O)	Fibra di vetro bianco / White Fibreglass - Interno giallo / yellow inside (Y) - Interno rosso / red inside (R) - Interno arancio / orange inside (O)			
02AP0302-G	Fibra di vetro oro / Gold Fibreglass- Interno oro / Gold inside			
SLICE Grande	COLORI / COLOURS			
02AP0701-(Y-R-O)	Fibra di carbonio / Carbon fibre - Interno giallo / yellow inside (Y) - Interno rosso / red inside (R) - Interno arancio / orange inside (O)			
02AP0702-(Y-R-O)	Fibra di vetro bianco / White Fibreglass - Interno giallo / yellow inside (Y) - Interno rosso / red inside (R) - Interno arancio / orange inside (O)			
02AP0702-G	Fibra di vetro oro / Gold Fibreglass - Interno oro / Gold inside			
	OPZIONI / OPTIONS			
DITV	Dimmer			
	CERTIFICATIONS			
	CERTIFICATIONS			
	CERTIFICATIONS			

02AP0302-R
02AP0402-R
02AP0702-R

02AP0302-O
02AP0402-O
02AP0702-O

02AP0302-Y
02AP0402-Y
02AP0702-Y

02AP0301-R
02AP0401-R
02AP0701-R

02AP0301-O
02AP0401-O
02AP0701-O

02AP0301-Y
02AP0401-Y
02AP0701-Y

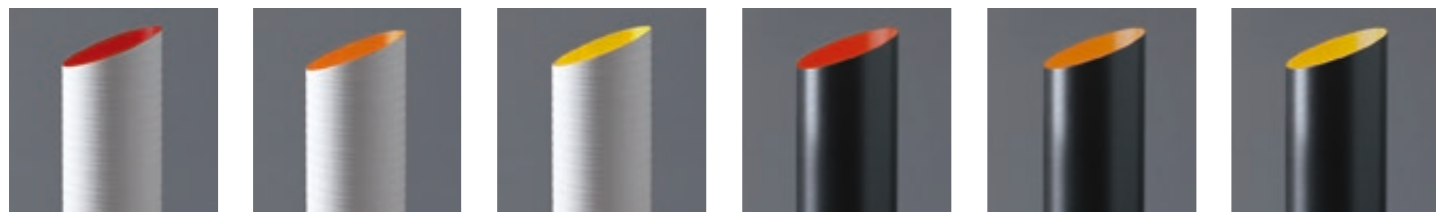

Slice Piccola / Media / Grande / Tavolo / Desk

Lampada da terra realizzata in fibra di carbonio oppure in composito di fibra di vetro verniciato. Su richiesta disponibile in tutti i colori.

Floor lamp in carbon fibre or in composite Fibreglass painted. On request, any color available.

02TR1802-G



Special Gold Edition (G)

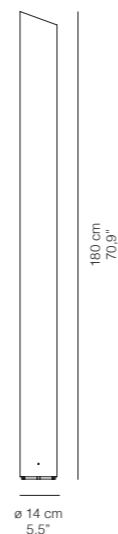

SLICE / Design Enrico Franzolini with Vicente Garcia Jimenez

SLICE Floor	Terra / Floor		SORGENTI LUMINOSE / LIGHT SOURCES			CERTIFICATIONS
	MISURE / DIMENSIONS					
	CM.	INCHES	HALOG.	LED	FLUO	
	14ø x 180H	5,5ø x 70,9H	max 1x100W E27 PAR 38	1x16W E27 PAR 38	1x23W E27 PAR 38	
	COLORI / COLOURS					
02TR1801-(Y-R-O)	Fibra di carbonio / Carbon fibre - Interno giallo/yellow inside (Y) - Interno rosso / red inside (R) - Interno arancio / orange inside (O)					
02TR1802-(Y-R-O)	Fibra di vetro bianco / White Fibreglass - Interno giallo / yellow inside (Y) - Interno rosso / red inside (R) - Interno arancio / orange inside (O)					
02TR1802-G	Fibra di vetro oro / Gold Fibreglass - Interno oro / Gold inside					
	OPZIONI / OPTIONS					
DITR	Dimmer					

02TR1802-R



02TR1802-O



02TR1802-Y



02TR1801-R



02TR1801-O



02TR1801-Y



SLICE Floor / Terra / Floor



TUBE /

Design Enrico Franzolini with Vicente Garcia Jimenez

Collezione composta da lampade a sospensione, parete e soffitto, disponibili in diversi diametri e lunghezze. I cilindri sono realizzati in fibra di carbonio o in composito di fibra di vetro verniciata.

Collection made up of hanging, wall and ceiling lamps, available in various diameters and lengths. The cylinders are in carbon fibre or in painted composite fibreglass.



Lampada a sospensione realizzata in fibra di carbonio oppure in composito di fibra di vetro verniciato. Su richiesta disponibile in tutti i colori.

Pendant lamp in carbon fibre or in composite Fibreglass painted. On request, any color available.

01SP03007
01SP04007
01SP07007



Special Gold Edition (G)

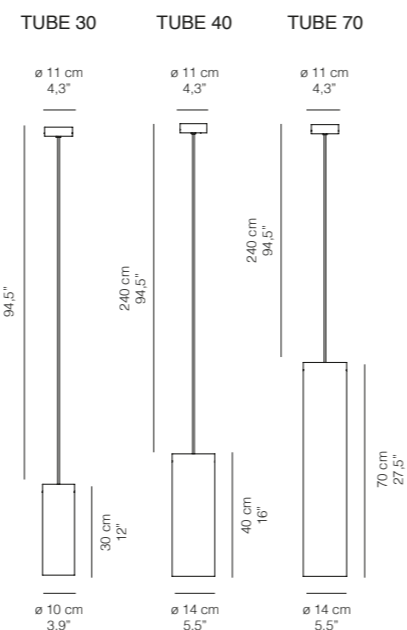

TUBE / Design Enrico Franzolini with Vicente Garcia Jimenez

Sospensione/ Pendant		SORGENTI LUMINOSE / LIGHT SOURCES			
MISURE / DIMENSIONS	CM.	INCHES	HALOG. ◀	LED Ⓞ	FLUO ▶
TUBE 30	10ø x 30-240H	3,9ø x 12-94,5H	max 1x75W E27 PAR 30S	1x11W 230V E27 PAR 30S	
TUBE 40	14ø x 40-240H	5,5ø x 16-94,5H	max 1x100W E27 PAR 38	1x16W E27 PAR 38	1x23W E27 PAR 38
TUBE 70	14ø x 70-240H	5,5ø x 27,5-94,5H	max 1x100W E27 PAR 38	1x16W E27 PAR 38	1x23W E27 PAR 38
TUBE 30		COLORI / COLOURS			
01SP03001		Fibra di carbonio / Carbon fibre			
01SP0300+2/3/5/6		Fibra di vetro / Fibreglass:: Bianco / White (2) - Rosso / Red (3) - Arancio / Orange (5) - Argento / Silver (6)			
01SP03007		Fibra di vetro oro / Gold Fibreglass - Interno oro / Gold inside			
TUBE 40		COLORI / COLOURS			
01SP04001		Fibra di carbonio / Carbon fibre			
01SP0400+2/3/5/6		Fibra di vetro / Fibreglass:: Bianco / White (2) - Rosso / Red (3) - Arancio / Orange (5) - Argento / Silver (6)			
01SP04007		Fibra di vetro oro / Gold Fibreglass - Interno oro / Gold inside			
TUBE 70		COLORI / COLOURS			
01SP07001		Fibra di carbonio / Carbon fibre			
01SP0700+2/3/5/6		Fibra di vetro / Fibreglass:: Bianco / White (2) - Rosso / Red (3) - Arancio / Orange (5) - Argento / Silver (6)			
01SP07007		Fibra di vetro oro / Gold Fibreglass - Interno oro / Gold inside			
OPZIONI / OPTIONS		CERTIFICATIONS			
5MT		Sospensione cablaggio lunghezza cavi mt. 5,00 / Pendant with longer cables mt. 5,00			
		CERTIFICATIONS			
		☐ ▽ CE IP 20 Ⓞ			
		CERTIFICATIONS			
		☐ ▽ CE IP 20 Ⓞ			
		CERTIFICATIONS			
		☐ ▽ CE IP 20 Ⓞ			

01SP03002
01SP04002
01SP07002



01SP03003
01SP04003
01SP07003



01SP03005
01SP04005
01SP07005



01SP03006
01SP04006
01SP07006



01SP03001
01SP04001
01SP07001

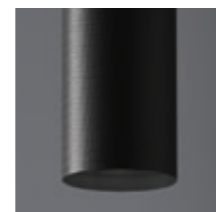

Tube 30-40-70 / Sospensione / Pendant

Lampada da soffitto realizzata in fibra di carbonio oppure in composito di fibra di vetro verniciato. Su richiesta disponibile in tutti i colori.

Ceiling lamp in carbon fibre or in composite Fibreglass painted. On request, any color available.

Tube 30-40-70 / Soffitto / Ceiling

01SF03007
01SF04007
01SF07007



Special Gold Edition (G)

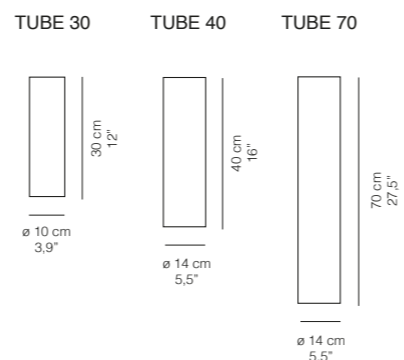

TUBE / Design Enrico Franzolini with Vicente Garcia Jimenez

Soffitto / Ceiling		SORGENTI LUMINOSE / LIGHT SOURCES			CERTIFICATIONS	
MISURE / DIMENSIONS		HALOG.	LED	FLUO	CERTIFICATIONS	
CM.	INCHES					
TUBE 30	10ø x 30H	3,9ø x 12H	max 1x75W E27 PAR 30S	1x11W 230V E27 PAR 30S		
TUBE 40	14ø x 40H	5,5ø x 16H	max 1x100W E27 PAR 38	1x16W E27 PAR 38	1x23W E27 PAR 38	
TUBE 70	14ø x 70H	5,5ø x 27,5H	max 1x100W E27 PAR 38	1x16W E27 PAR 38	1x23W E27 PAR 38	
TUBE 30	COLORI / COLOURS		CERTIFICATIONS			
01SF03001	Fibra di carbonio / Carbon fibre		☐ ▽ CE IP 20			
01SF0300+2/3/5/6	Fibra di vetro / Fibreglass:: Bianco / White (2) - Rosso / Red (3) - Arancio / Orange (5) - Argento / Silver (6)		☐ ▽ CE IP 20			
01SF03007	Fibra di vetro oro / Gold Fibreglass - Interno oro / Gold inside		☐ ▽ CE IP 20			
TUBE 40	COLORI / COLOURS		CERTIFICATIONS			
01SF04001	Fibra di carbonio / Carbon fibre		☐ ▽ CE IP 20			
01SF0400+2/3/5/6	Fibra di vetro / Fibreglass:: Bianco / White (2) - Rosso / Red (3) - Arancio / Orange (5) - Argento / Silver (6)		☐ ▽ CE IP 20			
01SF03007	Fibra di vetro oro / Gold Fibreglass - Interno oro / Gold inside		☐ ▽ CE IP 20			
TUBE 70	COLORI / COLOURS		CERTIFICATIONS			
01SF07001	Fibra di carbonio / Carbon fibre		☐ ▽ CE IP 20			
01SF0700+2/3/5/6	Fibra di vetro / Fibreglass:: Bianco / White (2) - Rosso / Red (3) - Arancio / Orange (5) - Argento / Silver (6)		☐ ▽ CE IP 20			
01SF07007	Fibra di vetro oro / Gold Fibreglass - Interno oro / Gold inside		☐ ▽ CE IP 20			

01SF03002
01SF04002
01SF07002

01SF03003
01SF04003
01SF07003

01SF03005
01SF04005
01SF07005

01SF03006
01SF04006
01SF07006

01SF03001
01SF04001
01SF07001



Lampada da parete realizzata in fibra di carbonio oppure in composito di fibra di vetro verniciato. A doppia emissione, diretta ed indiretta. Su richiesta disponibile in tutti i colori.

Wall-mounted lamp in carbon fibre or in composite Fibreglass painted. With direct/Indirect light emission. On request, any color available.

Tube / Parete / Wall-mounted

01PA04007



Special Gold Edition (G)

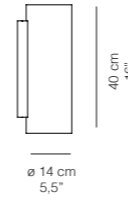

TUBE / Design Enrico Franzolini with Vicente Garcia Jimenez

TUBE	Parete / Wall		SORGENTI LUMINOSE / LIGHT SOURCES			CERTIFICATIONS
	MISURE / DIMENSIONS					
	CM.	INCHES	HALOG.	LED	FLUO	
	14ø x 40H	5,5ø x 16H	max 2x100W E27 PAR 38	2x16W E27 PAR 38	2x23W E27 PAR 38	
	COLORI / COLOURS					
01PA04001	Fibra di carbonio / Carbon fibre					
01PA0400+2/3/5/6	Fibra di vetro / Fibreglass:: Bianco / White (2) - Rosso / Red (3) - Arancio / Orange (5) - Argento / Silver (6)					
01PA04007	Fibra di vetro oro / Gold fibreglass - Interno oro / Gold inside					

01PA04002



01PA04003



01PA04005



01PA04006



01PA04001

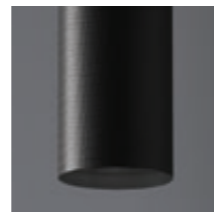

TUBE MICRO/

Design by Karboxx

Tube micro è un fascio di luce concentrato all'estremità di un sottile ma lungo cilindro a sospensione. Una linea snella, la struttura illuminante ma invisibile e la sua luce, precisa e puntuale come dar valore solo a ciò che ne ha.

Tube micro lascia spazio a composizioni di colore e finitura, di numero, lunghezza e altezza.

Leggera e ripetibile può essere usata per arredare e decorare spazi, creare pareti, cascate, aperture e atmosfere.

Tube Micro is a concentrated light beam that comes from the end of a thin but long pendant cylinder. The illuminating but invisible structure and its light are a slim line that is precise and punctual offering value only to what it has.

Tube Micro allows for compositions of color and finish, of number, length and height.

Described as light and repeatable, Tube Micro can be used to decorate spaces and to create walls, cascades, openings and atmospheres.



Lampada cilindrica a sospensione con luce diretta realizzata in fibra di carbonio o alluminio verniciato.

Cylindrical ceiling pendant lamp, direct light, available in carbon fibre and painted aluminium

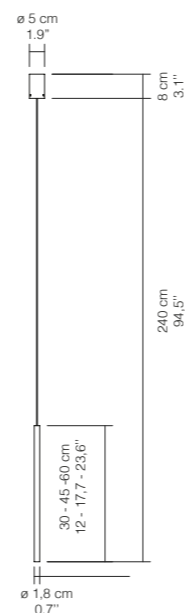

TUBE MICRO / Design Karboxx

Sospensione / Pendant		SORGENTI LUMINOSE / LIGHT SOURCES	
MISURE / DIMENSIONS			
CM.	INCHES	LED	
TUBE MICRO 30	5ø x 30-240H	1,9ø x 12-94,5H	1x2,1W - Lumen 210 - 2700K
TUBE MICRO 45	5ø x 45-240H	1,9ø x 17,7-94,5H	1x2,1W - Lumen 210 - 2700K
TUBE MICRO 60	5ø x 60-240H	1,9ø x 23,6-94,5H	1x2,1W - Lumen 210 - 2700K
COLORI / COLOURS		CERTIFICATIONS	
TUBE MICRO 30		CE IP 20 CLASSE 1	
01SP0301M	Fibra di carbonio / Carbon fibre		
01SP0300M-R	Alluminio verniciato Rose Gold/ Rose gold painted aluminium		
01SP0300M-B	Alluminio verniciato Nero Goffrato / Textured Black painted aluminium		
COLORI / COLOURS		CERTIFICATIONS	
TUBE MICRO 45		CE IP 20 CLASSE 1	
01SP0301M	Fibra di carbonio / Carbon fibre		
01SP0450M-R	Alluminio verniciato Rose Gold/ Rose gold painted aluminium		
01SP0450M-B	Alluminio verniciato Nero Goffrato / Textured Black painted aluminium		
COLORI / COLOURS		CERTIFICATIONS	
TUBE MICRO 60		CE IP 20 CLASSE 1	
01SP0601M	Fibra di carbonio / Carbon fibre		
01SP0600M-R	Alluminio verniciato Rose Gold/ Rose gold painted aluminium		
01SP0600M-B	Alluminio verniciato Nero Goffrato / Textured Black painted aluminium		
OPZIONI / OPTIONS			
01SP0003C	Composizione multipla 3 lampade / 3 lamp multiple composition		
01SP0005C	Composizione multipla 5 lampade / 5 lamp multiple composition		

01SP0300M
01SP0450M
01SP0600M

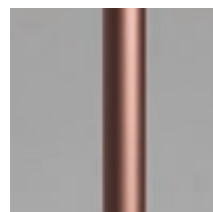

01SP0300M
01SP0450M
01SP0600M



01SP0301M
01SP0301M
01SP0601M



Tube Micro / Sospensione / Pendant



karboxx

LIGHT, MORE LIGHT.

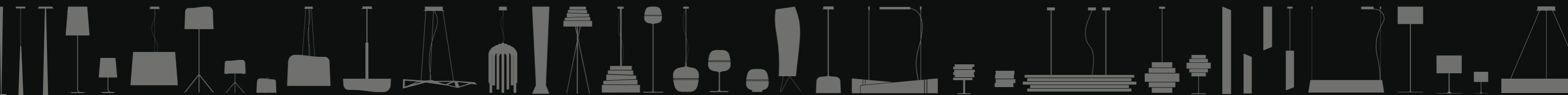

You might also be interested in...

Per completare il tuo progetto dai uno sguardo a tutto il nostro ventaglio prodotti che potrai trovare nei cataloghi dedicati.

To complete your project take a look at our range of products in the specialized catalogues.



LightSound
Office Lighting



More
Office Lighting



Microstick
Office Lighting



Flyup
Office Lighting



Ministick 2.0
Office Lighting



Fly
Office Lighting

Graphics:
wearenative.it

Photo:
wearenative.it

Print:
gfpprinting.com
September 2018 - Ed. 01
LIKDLCO1

Thanks to:
Enrico Franzolini
Acheo Srl p. 205
Luciano Franz Gioielleria
Arch. Curzio Pentimalli - Private house Treviso
Mastella Design

designed and
manufactured
in ITALY 

Technical and aesthetical details, finishes or other product features can be modified without notification.
Particolari tecnici, estetici, finiture o altro possono essere modificati senza preavviso.

KARBOXX S.R.L.
Società Unipersonale
Via Cornarè, 12 • Basalghelle
31040 Mansuè (TV) • Italy

www.karboxx.com
info@karboxx.com

