

VIBIA

VIBIA



Rastislav Sabo - KELMAX

Košovská cesta 24
971 01 Prievidza

e-mail: kelmax@kelmax.sk

www.kelmax.sk

tel.: +421 944 919 288

Index

Algorithm 44	Guise 80	Origami 113	Tube 165
Alpha 179	Halo <i>Circular</i> 84	Palma 97	Up 111
Ameba 76	Halo <i>Lineal</i> 86	Palo Alto 115	Vol 6
Balance 132	Halo <i>Jewel</i> 88	Pin 64	Warm 128
Bamboo 123	Halo <i>Wall</i> 90	Plis Outdoor 101	Wind 102
Big 33	I.Cono 41	Plus 38	Wireflow 10
BigBuilt-in 36	Jazz 60	Puck 138	Wireflow <i>Chandelier</i> 28
Break 106	Join 131	Puck Wall Art 141 / 143	Wireflow <i>Freeform</i> 22
Brisa 117	June 120	Quadra Ice 58	Wireflow <i>Lineal</i> 19
Centric 154	Linestra 181	Rhythm <i>Horizontal</i> 70	45° 185
Cosmos 91	Link 135	Rhythm <i>Vertical</i> 73	<hr/>
Curtain 169	Link XXL 133	Scotch 57	Bulbs 188
Domo 184	Match 186	Set 175	Professional area at vibia.com 189
Duo 126	Mayfair 147	Skon 7	Check product availability and place orders 190
Empty 108	Meridiano 119	Slim 53	Item coding 191
Flamingo 62	Micro 69	Structural 93	Glossary 192
Flex 43	Millenium 182	Suite 160	Lighting control systems 193
Fold <i>Surface</i> 109	Musa 173	Swing 31	
Funnel 67	North 149	Tempo 155	

Vol

Design by Lievore, Altherr, Molina

Vol combines traditional techniques and cutting-edge lighting capabilities. Smooth and streamlined, the simple oval forms create a delicate focal point in a space.



Pendants

0220

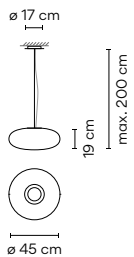

Light Source



4 x Core Pro LEDbulb E27 230V 9W.

Materials

Shade: Glass.
Disc: Aluminum.

Packaging

1 Box.
0,43 x 0,67 x 0,70 m.
Vol. 0,2017 m³.
Gross weight 8Kg.
Net weight 6,5 Kg.

0220 03 White
(RAL 9016)



0225

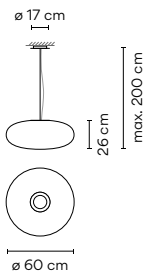

Light Source



4 x Core Pro LEDbulb E27 230V 9W.

Materials

Shade: Glass.
Disc: Aluminum.

Packaging

1 Box.
0,78 x 0,78 x 0,50 m.
Vol. 0,3000 m³.
Gross weight 11Kg.
Net weight 9 Kg.

0225 03 White
(RAL 9016)



Skán

Design by Lievore, Altherr, Molina

Minimal volume and maximum lighting functionality. Skán represents a return to what is essential: pure, delicate lines in which the light is the fundamental element while the shape is almost invisible.



Floor

0250

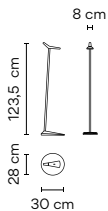

Light Source

LED
1 x LED PLATE 24V 8W.
LED 3000 K. CRI >80. 339,2 lm. 42,4 lm/W.
Driver Constant Voltage 24V.
100-240V. 50/60Hz.
Dimming: Optical Sensor.

Personalization options available
- Finish customization.
(Available options: Vibia color palette).
Min. quantity, upcharge and extra lead time apply.

Materials

Head: Aluminum.
Diffuser: Methacrylate.
Base: Zamak.

Packaging

1 Box.
1,50 x 0,34 x 0,32 m.
Vol. 0,0418 m³.
Gross weight 6Kg.
Net weight 3 Kg.

0250 10 /26 White
(NCS S 0300-N).

0250 11 /26 Black
(NCS S 8500-N).

0250 37 /26 Terra Red
(NCS S4040-Y70R).



0260

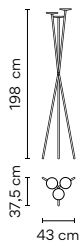

Light Source

LED
3 x LED 9,2W 500mA.
LED 2700 K. CRI >80. 2679 lm. 97,1 lm/W.
Driver Constant Current 500mA.
110-240V. 50/60Hz.
Dimming: Push.

Push button on the cord.
Electric cable 2,5 m.

Personalization options available
- Finish customization.
(Available options: Vibia color palette).
- LED 3000 K / 4000 K.
Min. quantity, upcharge and extra lead time apply.

Materials

Head: Aluminum.
Diffuser: Methacrylate.
Vertical tube: Steel.

Packaging

1 Box.
2,11 x 0,60 x 0,60 m.
Vol. 0,7596 m³.
Gross weight 5,4Kg.
Net weight 2,5 Kg.

0260 10 /15 White
(NCS S 0300-N).

0260 11 /15 Black
(NCS S 8500-N).

0260 37 /15 Terra Red
(NCS S4040-Y70R).



Pendants

0270

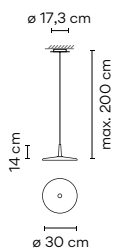

Light Source

1 x LED 9,3W 350mA.
LED 2700 K. CRI >80. 1041 lm. 116 lm/W.
Driver Constant Current 350mA.
 110-277V. 50/60Hz.
Dimming: 0-10V.

Surface.

Personalization options available

- Finish customization.
 (Available options: Vibia color palette).
 - LED 3000 K / 4000 K.
 - Dimming: DALI or Casambi.
 - Extra cable length.
- Min. quantity, upcharge and extra lead time apply.

Materials

Body: Aluminum.
 Diffuser: Methacrylate.
 Canopy Plate: Steel.

Packaging

1 Box.
 0,29 x 0,38 x 0,38 m.
 Vol. 0,0418 m³.
 Gross weight 2,6Kg.
 Net weight 1,4 Kg.

0270 10 /12 White
 (NCS S 0300-N).

0270 11 /12 Black
 (NCS S 8500-N).

0270 24 /12 Beige M1
 (NCS S 2005-Y50R).

0270 37 /12 Terra Red
 (NCS S4040-Y70R).

0270 42 /12 Blue M1
 (NCS S 5010-B10G).

0270 47 /12 Green L1
 (NCS S 4005-G80Y).



0271

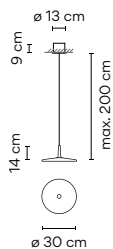

Light Source

1 x LED 9,3W 350mA.
LED 2700 K. CRI >80. 11041 lm. 116 lm/W.
Driver Constant Current 350mA.
 110-240V. 50/60Hz.
Dimming: 1-10V, Push.

Built-in.

Personalization options available

- Finish customization.
 (Available options: Vibia color palette).
 - LED 3000 K / 4000 K.
 - Dimming: DALI or Casambi.
 - Extra cable length.
- Min. quantity, upcharge and extra lead time apply.

Materials

Body: Aluminum.
 Diffuser: Methacrylate.
 Canopy Plate: Steel.

Packaging

1 Box.
 0,29 x 0,38 x 0,38 m.
 Vol. 0,0418 m³.
 Gross weight 2,6Kg.
 Net weight 1,4 Kg.

0271 10 /1B White
 (NCS S 0300-N).

0271 11 /1B Black
 (NCS S 8500-N).

0271 24 /1B Beige M1
 (NCS S 2005-Y50R).

0271 37 /1B Terra Red
 (NCS S4040-Y70R).

0271 42 /1B Blue M1
 (NCS S 5010-B10G).

0271 47 /1B Green L1
 (NCS S 4005-G80Y).



0275

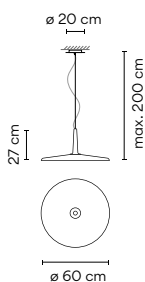

Light Source

1 x LED 13,9W 500mA.
LED 2700 K. CRI >80. 1380 lm. 106 lm/W.
Driver Constant Current 500mA.
 110-240V. 50/60Hz.
Dimming: 1-10V, Push.

Surface.

Personalization options available

- Finish customization.
 (Available options: Vibia color palette).
 - LED 3000 K / 4000 K.
 - Dimming: DALI or Casambi.
 - Extra cable length.
- Min. quantity, upcharge and extra lead time apply.

Materials

Body: Aluminum.
 Diffuser: Methacrylate.
 Canopy Plate: Steel.

Packaging

1 Box.
 0,42 x 0,71 x 0,66 m.
 Vol. 0,2000 m³.
 Gross weight 7Kg.
 Net weight 4,4 Kg.

0275 10 /1B White
 (NCS S 0300-N).

0275 11 /1B Black
 (NCS S 8500-N).

0275 24 /1B Beige M1
 (NCS S 2005-Y50R).

0275 37 /1B Terra Red
 (NCS S4040-Y70R).

0275 42 /1B Blue M1
 (NCS S 5010-B10G).

0275 47 /1B Green L1
 (NCS S 4005-G80Y).



0276

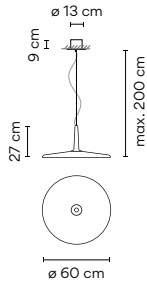

Light Source

1 x LED 13,9W 500mA.
LED 2700 K. CRI >80. 1380 lm. 106 lm/W.
Driver Constant Current 500mA.
 110-240V. 50/60Hz.
Dimming: 1-10V, Push.

Suitable for built-in and surface fitting.

Personalization options available

- Finish customization.
 (Available options: Vibia color palette).
 - LED 3000 K / 4000 K.
 - Dimming: DALI or Casambi.
 - Extra cable length.
- Min. quantity, upcharge and extra lead time apply.

Materials

Body: Aluminum.
 Diffuser: Methacrylate.
 Canopy Plate: Steel.

Packaging

1 Box.
 0,42 x 0,71 x 0,66 m.
 Vol. 0,2000 m³.
 Gross weight 7Kg.
 Net weight 4,4 Kg.

0276 10 /1B White
 (NCS S 0300-N).

0276 11 /1B Black
 (NCS S 8500-N).

0276 24 /1B Beige M1
 (NCS S 2005-Y50R).

0276 37 /1B Terra Red
 (NCS S4040-Y70R).

0276 42 /1B Blue M1
 (NCS S 5010-B10G).

0276 47 /1B Green L1
 (NCS S 4005-G80Y).



0280

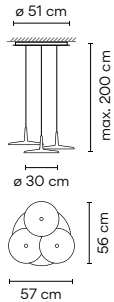

Light Source

3 x LED 9,3W 350mA.
LED 2700 K. CRI >80. 3123,1 lm. 116 lm/W.
Driver Constant Current 350mA.
 110-240V. 50/60Hz.
Dimming: 1-10V, Push.

Surface.

Personalization options available

- Finish customization.
 (Available options: Vibia color palette).
 - LED 3000 K / 4000 K.
 - Dimming: DALI or Casambi.
 - Extra cable length.
- Min. quantity, upcharge and extra lead time apply.

Materials

Body: Aluminum.
 Diffuser: Methacrylate.
 Canopy Plate: Steel.

Packaging

4 Box
 Total vol. 0,2226 m³.
 Gross weight 13,7Kg.
 Net weight 9,2 Kg.

0280 10 /1B White
 (NCS S 0300-N).

0280 11 /1B Black
 (NCS S 8500-N).

0280 24 /1B Beige M1
 (NCS S 2005-Y50R).

0280 37 /1B Terra Red
 (NCS S4040-Y70R).

0280 42 /1B Blue M1
 (NCS S 5010-B10G).

0280 47 /1B Green L1
 (NCS S 4005-G80Y).



0282

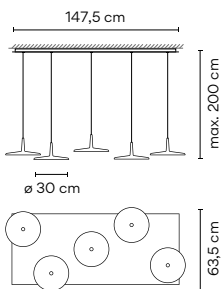

Light Source

5 x LED 9,3W 350mA.
LED 2700 K. CRI >80. 5205,2 lm. 116 lm/W.
Driver Constant Current 350mA.
 110-240V. 50/60Hz.
Dimming: 1-10V, Push.

Surface.

Personalization options available

- Finish customization.
 (Available options: Vibia color palette).
 - LED 3000 K / 4000 K.
 - Dimming: DALI or Casambi.
 - Extra cable length.
- Min. quantity, upcharge and extra lead time apply.

Materials

Body: Aluminum.
 Diffuser: Methacrylate.
 Canopy Plate: Steel.

Packaging

4 Box
 Total vol. 0,3290 m³.
 Gross weight 36,9Kg.
 Net weight 29 Kg.

0282 10 /1B White
 (NCS S 0300-N).

0282 11 /1B Black
 (NCS S 8500-N).

0282 24 /1B Beige M1
 (NCS S 2005-Y50R).

0282 37 /1B Terra Red
 (NCS S4040-Y70R).

0282 42 /1B Blue M1
 (NCS S 5010-B10G).

0282 47 /1B Green L1
 (NCS S 4005-G80Y).

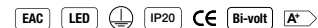

Wireflow

Design by Arik Levy

Crafted of black, electrical cables, Volumetric's airy, three-dimensional outline lends it the feeling of being at once present and absent. The geometric volumes are tipped with LED light terminals in a contemporary take on the traditional chandelier.

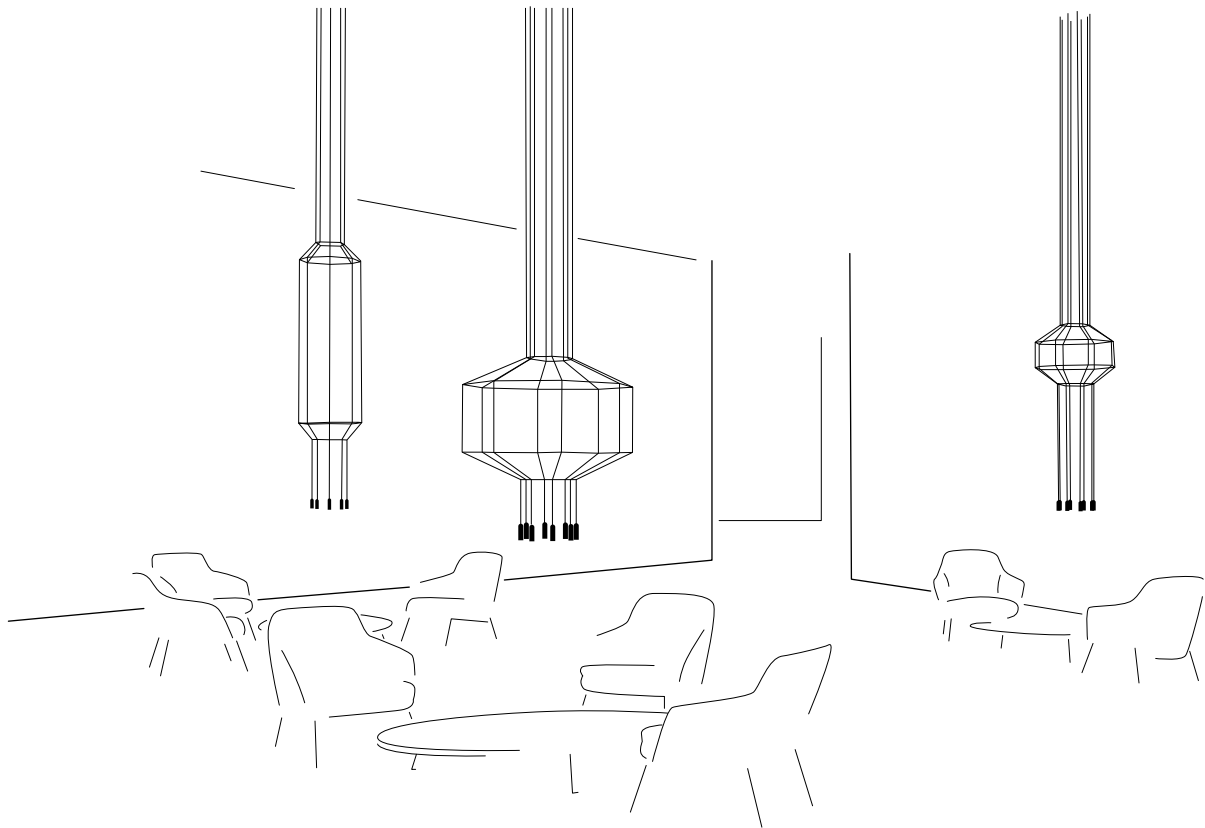

Wireflow

Create your product configuration quickly and easily at vibia.com

Go to vibia.com and discover the quickest, most effective way to configure a unique Wireflow design.

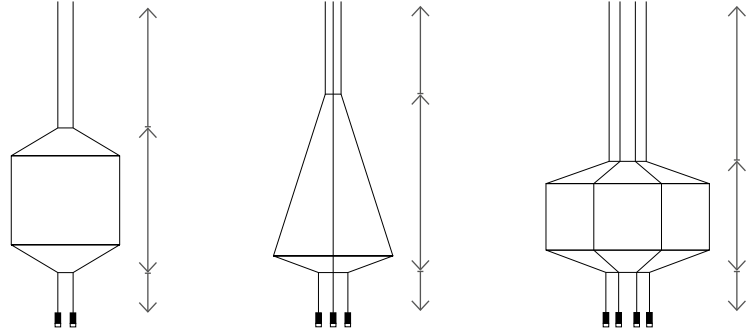

Pressed-glass diffuser.
Without pressed-glass diffuser.

Pendants

0299

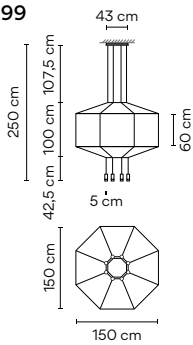

Light Source

8 x LED 4,5W 350mA.
LED 2700 K. CRI >80. 3922 lm. 109 lm/W.
Driver Constant Current 350mA.
100-240V. 50/60Hz.
Dimming: DALI, 1-10V, Push.

Pressed-glass diffuser.

Personalization options available

- Configuration layout at vibia.com
- LED 3000 K / 4000 K.
- Dimming: Casambi.

Min. quantity, upcharge and extra lead time apply.

Materials

Diffuser: Pressed-glass.
Horizontal rods: Steel.
Body: Aluminum.
Canopy: Steel.

Packaging

2 Boxes.
Total vol. 0,3245 m³.
Gross weight 20,6 Kg.
Net weight 9,6 Kg.

0299 04 /1A Black
(RAL 9005)



0300

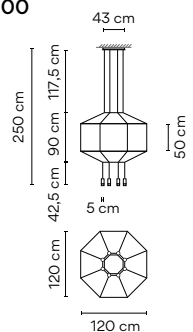

Light Source

8 x LED 4,5W 350mA.
LED 2700 K. CRI >80. 3922 lm. 109 lm/W.
Driver Constant Current 350mA.
100-240V. 50/60Hz.
Dimming: DALI, 1-10V, Push.

Pressed-glass diffuser.

Personalization options available

- Configuration layout at vibia.com
- LED 3000 K / 4000 K.
- Dimming: Casambi.

Min. quantity, upcharge and extra lead time apply.

Materials

Diffuser: Pressed-glass.
Horizontal rods: Steel.
Body: Aluminum.
Canopy: Steel.

Packaging

2 Boxes.
Total vol. 0,3246 m³.
Gross weight 19,95 Kg.
Net weight 8,95 Kg.

0300 04 /1A Black
(RAL 9005)



0301

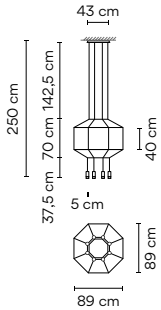

Light Source

8 x LED 4,5W 350mA.
LED 2700 K. CRI >80. 3922 lm. 109 lm/W.
Driver Constant Current 350mA.
 100-240V. 50/60Hz.
Dimming: DALI, 1-10V, Push.

Pressed-glass diffuser.

Personalization options available

- Configuration layout at vibia.com
 - LED 3000 K / 4000 K.
 - Dimming: Casambi.
- Min. quantity, upcharge and extra lead time apply.

Materials

Diffuser: Pressed-glass.
 Horizontal rods: Steel.
 Body: Aluminum.
 Canopy: Steel.

Packaging

2 Boxes.
 Total vol. 0,2100 m³.
 Gross weight 17,75 Kg.
 Net weight 8,75 Kg.

0301 04 /1A Black

(RAL 9005)



0302

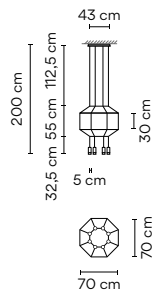

Light Source

8 x LED 4,5W 350mA.
LED 2700 K. CRI >80. 3922 lm. 109 lm/W.
Driver Constant Current 350mA.
 100-240V. 50/60Hz.
Dimming: DALI, 1-10V, Push.

Pressed-glass diffuser.

Personalization options available

- Configuration layout at vibia.com
 - LED 3000 K / 4000 K.
 - Dimming: Casambi.
- Min. quantity, upcharge and extra lead time apply.

Materials

Diffuser: Pressed-glass.
 Horizontal rods: Steel.
 Body: Aluminum.
 Canopy: Steel.

Packaging

2 Boxes.
 Total vol. 0,1558 m³.
 Gross weight 14,6 Kg.
 Net weight 8,6 Kg.

0302 04 /1A Black

(RAL 9005)



0303

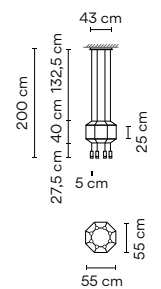

Light Source

8 x LED 4,5W 350mA.
LED 2700 K. CRI >80. 3922 lm. 109 lm/W.
Driver Constant Current 350mA.
 100-240V. 50/60Hz.
Dimming: DALI, 1-10V, Push.

Pressed-glass diffuser.

Personalization options available

- Configuration layout at vibia.com
 - LED 3000 K / 4000 K.
 - Dimming: Casambi.
- Min. quantity, upcharge and extra lead time apply.

Materials

Diffuser: Pressed-glass.
 Horizontal rods: Steel.
 Body: Aluminum.
 Canopy: Steel.

Packaging

2 Boxes.
 Total vol. 0,1558 m³.
 Gross weight 13 Kg.
 Net weight 8,5 Kg.

0303 04 /1A Black

(RAL 9005)



0304

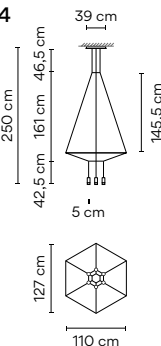

Light Source

6 x LED 4,5W 350mA.
LED 2700 K. CRI >80. 2942 lm. 109 lm/W.
Driver Constant Current 350mA.
 100-240V. 50/60Hz.
Dimming: DALI, 1-10V, Push.

Pressed-glass diffuser.

Personalization options available

- Configuration layout at vibia.com
 - LED 3000 K / 4000 K.
 - Dimming: Casambi.
- Min. quantity, upcharge and extra lead time apply.

Materials

Diffuser: Pressed-glass.
 Horizontal rods: Steel.
 Body: Aluminum.
 Canopy: Steel.

Packaging

2 Boxes.
 Total vol. 0,3245 m³.
 Gross weight 15,55 Kg.
 Net weight 5,65 Kg.

0304 04 /1A Black

(RAL 9005)



Wireflow

0305

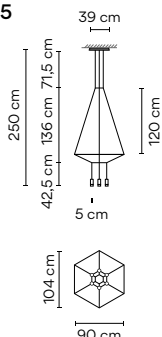

Light Source

6 x LED 4,5W 350mA.
LED 2700 K. CRI >80. 2942 lm. 109 lm/W.
Driver Constant Current 350mA.
 100-240V. 50/60Hz.
Dimming: DALI, 1-10V, Push.

Pressed-glass diffuser.

Personalization options available

- Configuration layout at vibia.com
- LED 3000 K / 4000 K.
- Dimming: Casambi.
- Min. quantity, upcharge and extra lead time apply.

Materials

Diffuser: Pressed-glass.
 Horizontal rods: Steel.
 Body: Aluminum.
 Canopy: Steel.

Packaging

2 Boxes.
 Total vol. 0,2100 m³.
 Gross weight 13,2 Kg.
 Net weight 3,5 Kg.

0305 04 /1A Black
 (RAL 9005)

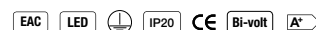

0306

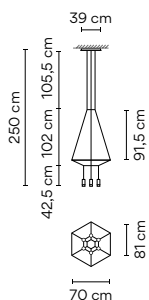

Light Source

6 x LED 4,5W 350mA.
LED 2700 K. CRI >80. 2942 lm. 109 lm/W.
Driver Constant Current 350mA.
 100-240V. 50/60Hz.
Dimming: DALI, 1-10V, Push.

Pressed-glass diffuser.

Personalization options available

- Configuration layout at vibia.com
- LED 3000 K / 4000 K.
- Dimming: Casambi.
- Min. quantity, upcharge and extra lead time apply.

Materials

Diffuser: Pressed-glass.
 Horizontal rods: Steel.
 Body: Aluminum.
 Canopy: Steel.

Packaging

2 Boxes.
 Total vol. 0,2100 m³.
 Gross weight 13,1 Kg.
 Net weight 5,2 Kg.

0306 04 /1A Black
 (RAL 9005)

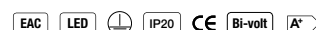

0307

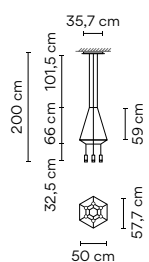

Light Source

6 x LED 4,5W 350mA.
LED 2700 K. CRI >80. 2942 lm. 109 lm/W.
Driver Constant Current 350mA.
 100-240V. 50/60Hz.
Dimming: DALI, 1-10V, Push.

Pressed-glass diffuser.

Personalization options available

- Configuration layout at vibia.com
- LED 3000 K / 4000 K.
- Dimming: Casambi.
- Min. quantity, upcharge and extra lead time apply.

Materials

Diffuser: Pressed-glass.
 Horizontal rods: Steel.
 Body: Aluminum.
 Canopy: Steel.

Packaging

2 Boxes.
 Total vol. 0,1558 m³.
 Gross weight 10 Kg.
 Net weight 5,1 Kg.

0307 04 /1A Black
 (RAL 9005)



0308

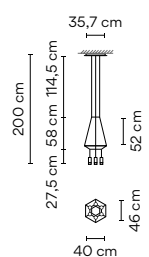

Light Source

6 x LED 4,5W 350mA.
LED 2700 K. CRI >80. 2942 lm. 109 lm/W.
Driver Constant Current 350mA.
 100-240V. 50/60Hz.
Dimming: DALI, 1-10V, Push.

Pressed-glass diffuser.

Personalization options available

- Configuration layout at vibia.com
- LED 3000 K / 4000 K.
- Dimming: Casambi.
- Min. quantity, upcharge and extra lead time apply.

Materials

Diffuser: Pressed-glass.
 Horizontal rods: Steel.
 Body: Aluminum.
 Canopy: Steel.

Packaging

2 Boxes.
 Total vol. 0,1238 m³.
 Gross weight 8,4 Kg.
 Net weight 5,0 Kg.

0308 04 /1A Black
 (RAL 9005)



0309

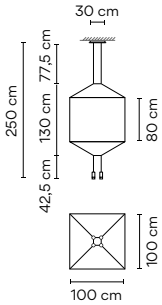

Light Source

④
 4 x LED 4,5W 350mA.
LED 2700 K. CRI >80. 1961 lm. 109 lm/W.
Driver Constant Current 350mA.
 100-240V. 50/60Hz.
Dimming: DALI, 1-10V, Push.

Pressed-glass diffuser.

Personalization options available

- Configuration layout at vibia.com
 - LED 3000 K / 4000 K.
 - Dimming: Casambi.
- Min. quantity, upcharge and extra lead time apply.

Materials

Diffuser: Pressed-glass.
 Horizontal rods: Steel.
 Body: Aluminum.
 Canopy: Steel.

Packaging

2 Boxes.
 Total vol. 0,2100 m³.
 Gross weight 12,3 Kg.
 Net weight 5,3 Kg.

0309 04 /1A Black
 (RAL 9005)



0310

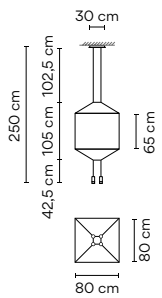

Light Source

④
 4 x LED 4,5W 350mA.
LED 2700 K. CRI >80. 1961 lm. 109 lm/W.
Driver Constant Current 350mA.
 100-240V. 50/60Hz.
Dimming: DALI, 1-10V, Push.

Pressed-glass diffuser.

Personalization options available

- Configuration layout at vibia.com
 - LED 3000 K / 4000 K.
 - Dimming: Casambi.
- Min. quantity, upcharge and extra lead time apply.

Materials

Diffuser: Pressed-glass.
 Horizontal rods: Steel.
 Body: Aluminum.
 Canopy: Steel.

Packaging

2 Boxes.
 Total vol. 0,2100 m³.
 Gross weight 11,8 Kg.
 Net weight 4,8 Kg.

0310 04 /1A Black
 (RAL 9005)



0311

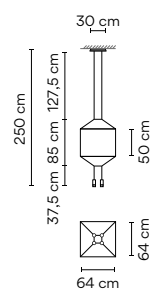

Light Source

④
 4 x LED 4,5W 350mA.
LED 2700 K. CRI >80. 1961 lm. 109 lm/W.
Driver Constant Current 350mA.
 100-240V. 50/60Hz.
Dimming: DALI, 1-10V, Push.

Pressed-glass diffuser.

Personalization options available

- Configuration layout at vibia.com
 - LED 3000 K / 4000 K.
 - Dimming: Casambi.
- Min. quantity, upcharge and extra lead time apply.

Materials

Diffuser: Pressed-glass.
 Horizontal rods: Steel.
 Body: Aluminum.
 Canopy: Steel.

Packaging

2 Boxes.
 Total vol. 0,1558 m³.
 Gross weight 8,7 Kg.
 Net weight 4,7 Kg.

0311 04 /1A Black
 (RAL 9005)



0312

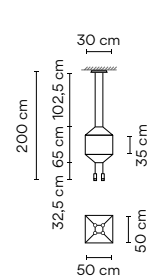

Light Source

④
 4 x LED 4,5W 350mA.
LED 2700 K. CRI >80. 1961 lm. 109 lm/W.
Driver Constant Current 350mA.
 100-240V. 50/60Hz.
Dimming: DALI, 1-10V, Push.

Pressed-glass diffuser.

Personalization options available

- Configuration layout at vibia.com
 - LED 3000 K / 4000 K.
 - Dimming: Casambi.
- Min. quantity, upcharge and extra lead time apply.

Materials

Diffuser: Pressed-glass.
 Horizontal rods: Steel.
 Body: Aluminum.
 Canopy: Steel.

Packaging

2 Boxes.
 Total vol. 0,1558 m³.
 Gross weight 8,6 Kg.
 Net weight 4,6 Kg.

0312 04 /1A Black
 (RAL 9005)

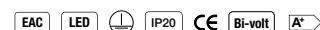

0313

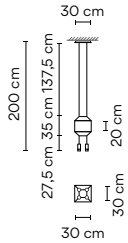

Light Source

Ⓢ
 4 x LED 4,5W 350mA.
LED 2700 K. CRI >80. 1961 lm. 109 lm/W.
Driver Constant Current 350mA.
 100-240V. 50/60Hz.
Dimming: DALI, 1-10V, Push.

Pressed-glass diffuser.

Personalization options available

- Configuration layout at vibia.com
 - LED 3000 K / 4000 K.
 - Dimming: Casambi.
- Min. quantity, upcharge and extra lead time apply.

Materials

Diffuser: Pressed-glass.
 Horizontal rods: Steel.
 Body: Aluminum.
 Canopy: Steel.

Packaging

2 Boxes.
 Total vol. 0,1238 m³.
 Gross weight 7 Kg.
 Net weight 4,5 Kg.

0313 04 /1A Black

(RAL 9005)



0399

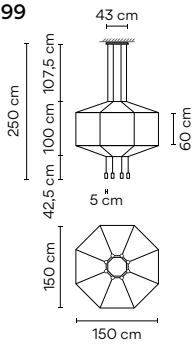

Light Source

Ⓢ
 8 x LED 4,5W 350mA.
LED 2700 K. CRI >80. 3922 lm. 109 lm/W.
Driver Constant Current 350mA.
 100-240V. 50/60Hz.
Dimming: DALI, 1-10V, Push.

Without pressed-glass diffuser.

Personalization options available

- Configuration layout at vibia.com
 - LED 3000 K / 4000 K.
 - Dimming: Casambi.
- Min. quantity, upcharge and extra lead time apply.

Materials

Diffuser: Polycarbonate.
 Horizontal rods: Steel.
 Body: Aluminum.
 Canopy: Steel.

Packaging

2 Boxes.
 Total vol. 0,3245 m³.
 Gross weight 20,6 Kg.
 Net weight 9,6 Kg.

0399 04 /1A Black

(RAL 9005)



0400

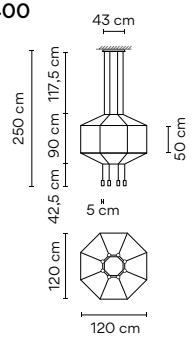

Light Source

Ⓢ
 8 x LED 4,5W 350mA.
LED 2700 K. CRI >80. 3922 lm. 109 lm/W.
Driver Constant Current 350mA.
 100-240V. 50/60Hz.
Dimming: DALI, 1-10V, Push.

Without pressed-glass diffuser.

Personalization options available

- Configuration layout at vibia.com
 - LED 3000 K / 4000 K.
 - Dimming: Casambi.
- Min. quantity, upcharge and extra lead time apply.

Materials

Diffuser: Polycarbonate.
 Horizontal rods: Steel.
 Body: Aluminum.
 Canopy: Steel.

Packaging

2 Boxes.
 Total vol. 0,3245 m³.
 Gross weight 20,20 Kg.
 Net weight 8,95 Kg.

0400 04 /1A Black

(RAL 9005)



0401

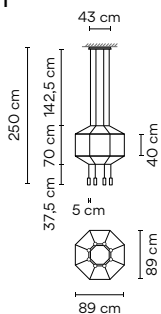

Light Source

Ⓢ
 8 x LED 4,5W 350mA.
LED 2700 K. CRI >80. 3922 lm. 109 lm/W.
Driver Constant Current 350mA.
 100-240V. 50/60Hz.
Dimming: DALI, 1-10V, Push.

Without pressed-glass diffuser.

Personalization options available

- Configuration layout at vibia.com
 - LED 3000 K / 4000 K.
 - Dimming: Casambi.
- Min. quantity, upcharge and extra lead time apply.

Materials

Diffuser: Polycarbonate.
 Horizontal rods: Steel.
 Body: Aluminum.
 Canopy: Steel.

Packaging

2 Boxes.
 Total vol. 0,2100 m³.
 Gross weight 17,75 Kg.
 Net weight 8,75 Kg..

0401 04 /1A Black

(RAL 9005)

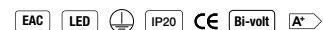

0402

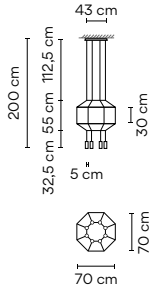

Light Source



8 x LED 4,5W 350mA.
LED 2700 K. CRI >80. 3922 lm. 109 lm/W.
Driver Constant Current 350mA.
 100-240V. 50/60Hz.
Dimming: DALI, 1-10V, Push.

Without pressed-glass diffuser.

Personalization options available

- Configuration layout at vibia.com
 - LED 3000 K / 4000 K.
 - Dimming: Casambi.
- Min. quantity, upcharge and extra lead time apply.

Materials

Diffuser: Polycarbonate.
 Horizontal rods: Steel.
 Body: Aluminum.
 Canopy: Steel.

Packaging

2 Boxes.
 Total vol. 0,1558 m³.
 Gross weight 16,95 Kg.
 Net weight 8,6 Kg.

0402 04 /1A Black
 (RAL 9005)



0403

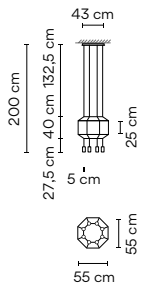

Light Source



8 x LED 4,5W 350mA.
LED 2700 K. CRI >80. 3922 lm. 109 lm/W.
Driver Constant Current 350mA.
 100-240V. 50/60Hz.
Dimming: DALI, 1-10V, Push.

Without pressed-glass diffuser.

Personalization options available

- Configuration layout at vibia.com
 - LED 3000 K / 4000 K.
 - Dimming: Casambi.
- Min. quantity, upcharge and extra lead time apply.

Materials

Diffuser: Polycarbonate.
 Horizontal rods: Steel.
 Body: Aluminum.
 Canopy: Steel.

Packaging

2 Boxes.
 Total vol. 0,1558 m³.
 Gross weight 16,65 Kg.
 Net weight 8,5 Kg.

0403 04 /1A Black
 (RAL 9005)



0404

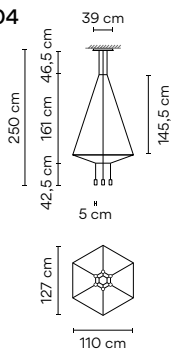

Light Source



6 x LED 4,5W 350mA.
LED 2700 K. CRI >80. 2942 lm. 109 lm/W.
Driver Constant Current 350mA.
 100-240V. 50/60Hz.
Dimming: DALI, 1-10V, Push.

Without pressed-glass diffuser.

Personalization options available

- Configuration layout at vibia.com
 - LED 3000 K / 4000 K.
 - Dimming: Casambi.
- Min. quantity, upcharge and extra lead time apply.

Materials

Diffuser: Polycarbonate.
 Horizontal rods: Steel.
 Body: Aluminum.
 Canopy: Steel.

Packaging

2 Boxes.
 Total vol. 0,3245 m³.
 Gross weight 13,1 Kg.
 Net weight 5,65 Kg.

0404 04 /1A Black
 (RAL 9005)



0405

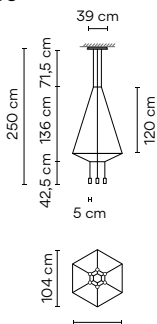

Light Source



6 x LED 4,5W 350mA.
LED 2700 K. CRI >80. 2942 lm. 109 lm/W.
Driver Constant Current 350mA.
 100-240V. 50/60Hz.
Dimming: DALI, 1-10V, Push.

Without pressed-glass diffuser.

Personalization options available

- Configuration layout at vibia.com
 - LED 3000 K / 4000 K.
 - Dimming: Casambi.
- Min. quantity, upcharge and extra lead time apply.

Materials

Diffuser: Polycarbonate.
 Horizontal rods: Steel.
 Body: Aluminum.
 Canopy: Steel.

Packaging

2 Boxes.
 Total vol. 0,3245 m³.
 Gross weight 13,1 Kg.
 Net weight 5,65 Kg.

0405 04 /1A Black
 (RAL 9005)



0406

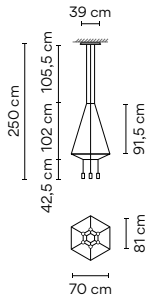

Light Source

Ⓜ
6 x LED 4,5W 350mA.
LED 2700 K. CRI >80. 2942 lm. 109 lm/W.
Driver Constant Current 350mA.
100-240V. 50/60Hz.
Dimming: DALI, 1-10V, Push.

Without pressed-glass diffuser.

Personalization options available

- Configuration layout at vibia.com
 - LED 3000 K / 4000 K.
 - Dimming: Casambi.
- Min. quantity, upcharge and extra lead time apply.

Materials

Diffuser: Polycarbonate.
Horizontal rods: Steel.
Body: Aluminum.
Canopy: Steel.

Packaging

2 Boxes.
Total vol. 0,2100 m³.
Gross weight 11,7 Kg.
Net weight 5,2 Kg

0406 04 /1A Black
(RAL 9005)



0407

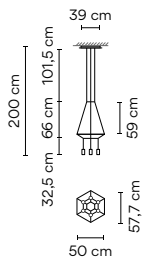

Light Source

Ⓜ
6 x LED 4,5W 350mA.
LED 2700 K. CRI >80. 2942 lm. 109 lm/W.
Driver Constant Current 350mA.
100-240V. 50/60Hz.
Dimming: DALI, 1-10V, Push.

Without pressed-glass diffuser.

Personalization options available

- Configuration layout at vibia.com
 - LED 3000 K / 4000 K.
 - Dimming: Casambi.
- Min. quantity, upcharge and extra lead time apply.

Materials

Diffuser: Polycarbonate.
Horizontal rods: Steel.
Body: Aluminum.
Canopy: Steel.

Packaging

2 Boxes.
Total vol. 0,2100 m³.
Gross weight 11,7 Kg.
Net weight 5,2 Kg

0407 04 /1A Black
(RAL 9005)



0408

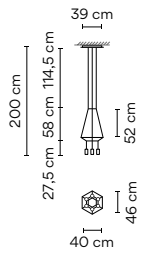

Light Source

Ⓜ
6 x LED 4,5W 350mA.
LED 2700 K. CRI >80. 2942 lm. 109 lm/W.
Driver Constant Current 350mA.
100-240V. 50/60Hz.
Dimming: DALI, 1-10V, Push.

Without pressed-glass diffuser.

Personalization options available

- Configuration layout at vibia.com
 - LED 3000 K / 4000 K.
 - Dimming: Casambi.
- Min. quantity, upcharge and extra lead time apply.

Materials

Diffuser: Polycarbonate.
Horizontal rods: Steel.
Body: Aluminum.
Canopy: Steel.

Packaging

2 Boxes.
Total vol. 0,1238 m³.
Gross weight 8,4 Kg.
Net weight 5 Kg

0408 04 /1A Black
(RAL 9005)



0409

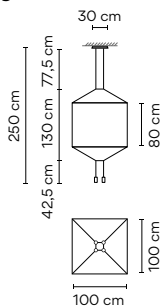

Light Source

Ⓜ
4 x LED 4,5W 350mA.
LED 2700 K. CRI >80. 1961 lm. 109 lm/W.
Driver Constant Current 350mA.
100-240V. 50/60Hz.
Dimming: DALI, 1-10V, Push.

Without pressed-glass diffuser.

Personalization options available

- Configuration layout at vibia.com
 - LED 3000 K / 4000 K.
 - Dimming: Casambi.
- Min. quantity, upcharge and extra lead time apply.

Materials

Diffuser: Polycarbonate.
Horizontal rods: Steel.
Body: Aluminum.
Canopy: Steel.

Packaging

2 Boxes.
Total vol. 0,2100 m³.
Gross weight 12,3 Kg.
Net weight 5,3 Kg

0409 04 /1A Black
(RAL 9005)



O410

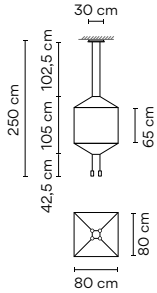

Light Source

Ⓢ
 4 x LED 4,5W 350mA.
LED 2700 K. CRI >80. 1961 lm. 109 lm/W.
Driver Constant Current 350mA.
 100-240V. 50/60Hz.
Dimming: DALI, 1-10V, Push.

Without pressed-glass diffuser.

Personalization options available

- Configuration layout at vibia.com
 - LED 3000 K / 4000 K.
 - Dimming: Casambi.
- Min. quantity, upcharge and extra lead time apply.

Materials

Diffuser: Polycarbonate.
 Horizontal rods: Steel.
 Body: Aluminum.
 Canopy: Steel.

Packaging

2 Boxes.
 Total vol. 0,2100 m³.
 Gross weight 11,8 Kg.
 Net weight 4,8 Kg

O410 O4 /1A Black
 (RAL 9005)



O411

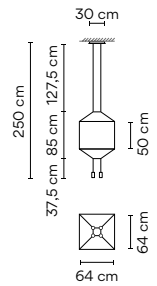

Light Source

Ⓢ
 4 x LED 4,5W 350mA.
LED 2700 K. CRI >80. 1961 lm. 109 lm/W.
Driver Constant Current 350mA.
 100-240V. 50/60Hz.
Dimming: DALI, 1-10V, Push.

Without pressed-glass diffuser.

Personalization options available

- Configuration layout at vibia.com
 - LED 3000 K / 4000 K.
 - Dimming: Casambi.
- Min. quantity, upcharge and extra lead time apply.

Materials

Diffuser: Polycarbonate.
 Horizontal rods: Steel.
 Body: Aluminum.
 Canopy: Steel.

Packaging

2 Boxes.
 Total vol. 0,1558 m³.
 Gross weight 11,4 Kg.
 Net weight 4,7 Kg

O411 O4 /1A Black
 (RAL 9005)



O412

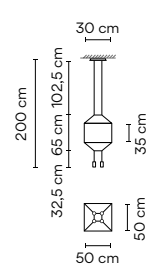

Light Source

Ⓢ
 4 x LED 4,5W 350mA.
LED 2700 K. CRI >80. 1961 lm. 109 lm/W.
Driver Constant Current 350mA.
 100-240V. 50/60Hz.
Dimming: DALI, 1-10V, Push.

Without pressed-glass diffuser.

Personalization options available

- Configuration layout at vibia.com
 - LED 3000 K / 4000 K.
 - Dimming: Casambi.
- Min. quantity, upcharge and extra lead time apply.

Materials

Diffuser: Polycarbonate.
 Horizontal rods: Steel.
 Body: Aluminum.
 Canopy: Steel.

Packaging

2 Boxes.
 Total vol. 0,1558 m³.
 Gross weight 11,2 Kg.
 Net weight 4,6 Kg

O412 O4 /1A Black
 (RAL 9005)



O413

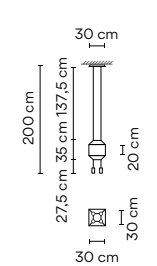

Light Source

Ⓢ
 4 x LED 4,5W 350mA.
LED 2700 K. CRI >80. 1961 lm. 109 lm/W.
Driver Constant Current 350mA.
 100-240V. 50/60Hz.
Dimming: DALI, 1-10V, Push.

Without pressed-glass diffuser.

Personalization options available

- Configuration layout at vibia.com
 - LED 3000 K / 4000 K.
 - Dimming: Casambi.
- Min. quantity, upcharge and extra lead time apply.

Materials

Diffuser: Polycarbonate.
 Horizontal rods: Steel.
 Body: Aluminum.
 Canopy: Steel.

Packaging

2 Boxes.
 Total vol. 0,1238 m³.
 Gross weight 7 Kg.
 Net weight 4,5 Kg

O413 O4 /1A Black
 (RAL 9005)

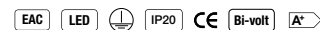

Wireflow Lineal

Design by Arik Levy

Crafted of black, electrical cables and lacquered metal rods, Lineal traces an airy, two-dimensional outline that lends it a powerful graphic presence. The slim cables are tipped with LED terminals and can be customised.

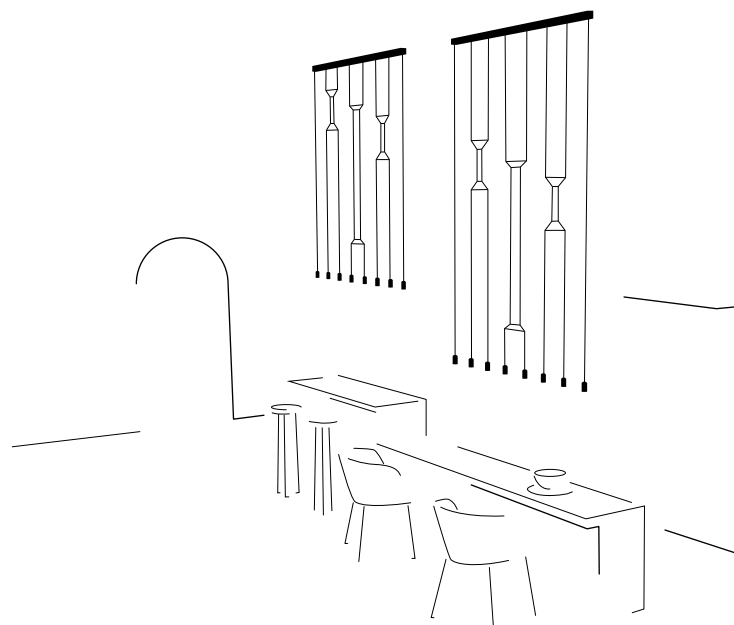
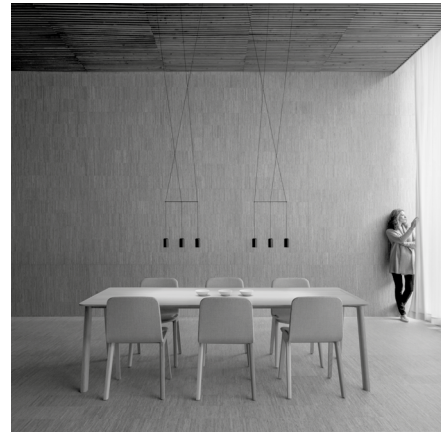
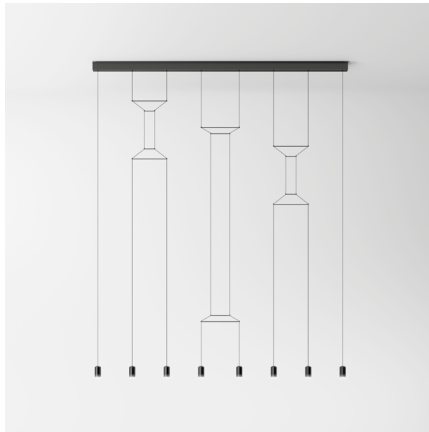

Without pressed-glass diffuser.

Create your product configuration quickly and easily at vibia.com

Go to vibia.com and discover the quickest, most effective way to configure a unique Wireflow design.

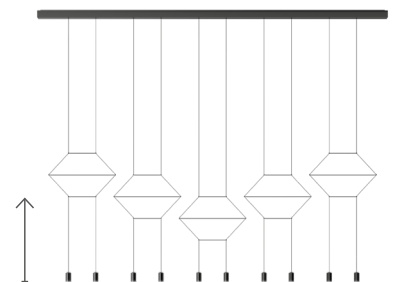
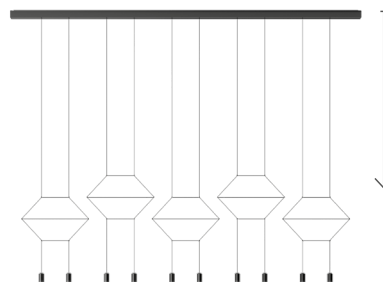

Wireflow Lineal

Pendants

0320

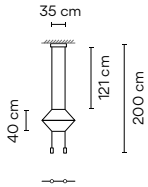

Light Source

2 x LED 4,5W 350mA.
LED 2700 K. CRI >80. 980,5 lm. 109 lm/W.
Driver Constant Current 350mA.
 110-240V. 50/60Hz.
Dimming: 1-10V, Push.

Linear canopy.

Personalization options available

- Configuration layout at vibia.com
 - LED 3000 K / 4000 K.
 - Dimming: DALI.
- Min. quantity, upcharge and extra lead time apply.

Materials

Diffuser: Polycarbonate.
 Horizontal rods: Steel.
 Body: Aluminum.
 Canopy: Aluminum.

Packaging

1 Box.
 0,20 x 0,075 x 0,70 m.
 Vol. 0,0150 m³.
 Gross weight 5,1 Kg.
 Net weight 2,6 Kg.

0320 04 /1B Black
 (RAL 9005)



0325

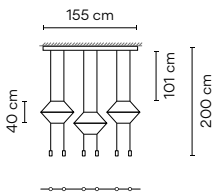

Light Source

6 x LED 4,5W 350mA.
LED 2700 K. CRI >80. 2942 lm. 109 lm/W.
Driver Constant Current 350mA.
 110-240V. 50/60Hz.
Dimming: 1-10V, Push.

Linear canopy.

Personalization options available

- Configuration layout at vibia.com
 - LED 3000 K / 4000 K.
 - Dimming: DALI.
- Min. quantity, upcharge and extra lead time apply.

Materials

Diffuser: Polycarbonate.
 Horizontal rods: Steel.
 Body: Aluminum.
 Canopy: Aluminum.

Packaging

1 Box.
 0,20 x 0,075 x 2,30 m.
 Vol. 0,0345 m³.
 Gross weight 8 Kg.
 Net weight 4,5 Kg.

0325 04 /1B Black
 (RAL 9005)



0330

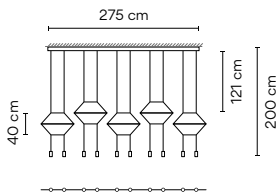

Light Source

10 x LED 4,5W 350mA.
LED 2700 K. CRI >80. 4902,7 lm. 109 lm/W.
Driver Constant Current 350mA.
 220-240V. 50/60Hz.
Dimming: 1-10V, Push.

Linear canopy.

Personalization options available

- Configuration layout at vibia.com
 - LED 3000 K / 4000 K.
 - Dimming: DALI.
- Min. quantity, upcharge and extra lead time apply.

Materials

Diffuser: Polycarbonate.
 Horizontal rods: Steel.
 Body: Aluminum.
 Canopy: Aluminum.

Packaging

1 Box.
 0,20 x 0,075 x 3,30 m.
 Vol. 0,0495 m³.
 Gross weight 9,5 Kg.
 Net weight 5,0 Kg.

0330 04 /1B Black
 (RAL 9005)



Wireflow Lineal

0332

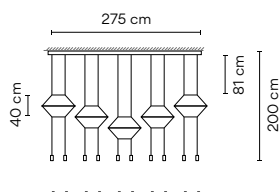

Light Source

10 x LED 4,5W 350mA.
LED 2700 K. CRI >80. 4902,7 lm. 109 lm/W.
Driver Constant Current 350mA.
 220-240V. 50/60Hz.
Dimming: 1-10V, Push.

Linear canopy.

Personalization options available

- Configuration layout at vibia.com
 - LED 3000 K / 4000 K.
 - Dimming: DALI.
- Min. quantity, upcharge and extra lead time apply.

Materials

Diffuser: Polycarbonate.
 Horizontal rods: Steel.
 Body: Aluminum.
 Canopy: Aluminum.

Packaging

1 Box.
 0,20 x 0,075 x 3,30 m.
 Vol. 0,0495 m³.
 Gross weight 9,5 Kg.
 Net weight 5,0 Kg.

0332 04 /1B Black
 (RAL 9005)



0338

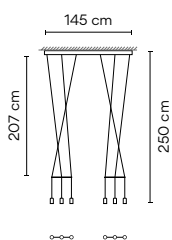

Light Source

6 x LED 4,5W 350mA.
LED 2700 K. CRI >80. 2942 lm. 109 lm/W.
Driver Constant Current 350mA.
 110-240V. 50/60Hz.
Dimming: 1-10V, Push.

Linear canopy.

Personalization options available

- Configuration layout at vibia.com
 - LED 3000 K / 4000 K.
 - Dimming: DALI.
- Min. quantity, upcharge and extra lead time apply.

Materials

Diffuser: Polycarbonate.
 Horizontal rods: Steel.
 Body: Aluminum.
 Canopy: Aluminum.

Packaging

1 Box.
 0,20 x 0,075 x 2,30 m.
 Vol. 0,0345 m³.
 Gross weight 9,2 Kg.
 Net weight 8,3 Kg.

0338 04 /1B Black
 (RAL 9005)



0340

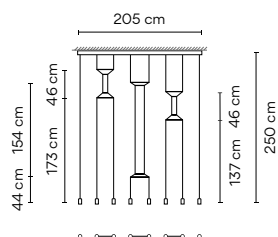

Light Source

8 x LED 4,5W 350mA.
LED 2700 K. CRI >80. 3922 lm. 109 lm/W.
Driver Constant Current 350mA.
 220-240V. 50/60Hz.
Dimming: 1-10V, Push.

Linear canopy.

Personalization options available

- Configuration layout at vibia.com
 - LED 3000 K / 4000 K.
 - Dimming: DALI.
- Min. quantity, upcharge and extra lead time apply.

Materials

Diffuser: Polycarbonate.
 Horizontal rods: Steel.
 Body: Aluminum.
 Canopy: Aluminum.

Packaging

1 Box.
 0,20 x 0,075 x 2,30 m.
 Vol. 0,0345 m³.
 Gross weight 10,2 Kg.
 Net weight 9,3 Kg.

0340 04 /1B Black
 (RAL 9005)



Wireflow FreeForm

Design by Arik Levy

Crafted of lean, electrical cables that trace airy, geometric outlines, Free Form is equal parts light and fluidity. The customisable fixture features endlessly adjustable shapes and heights, LED light points, and a wall or ceiling canopy to suit any space.

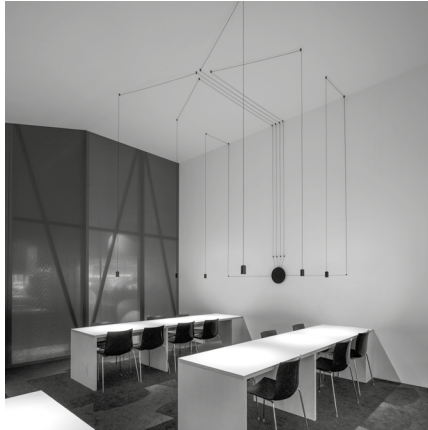

Pressed-glass diffuser.
Without pressed-glass diffuser.

Create your product configuration quickly and easily at vibia.com

Go to vibia.com and discover the quickest, most effective way to configure a unique Wireflow design.

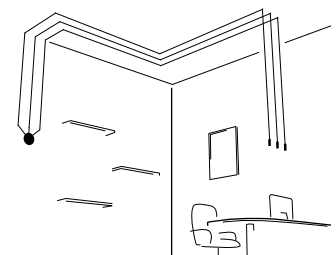
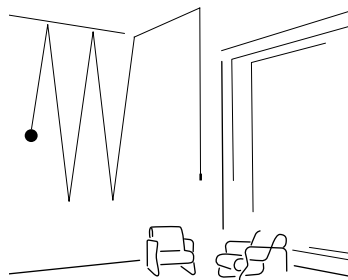
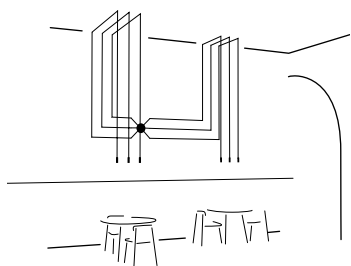
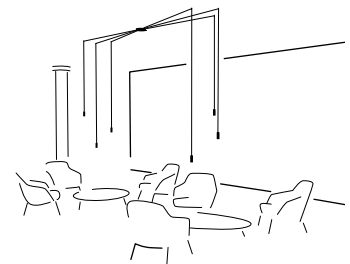
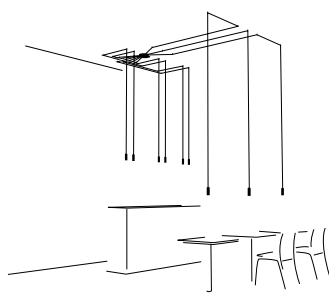
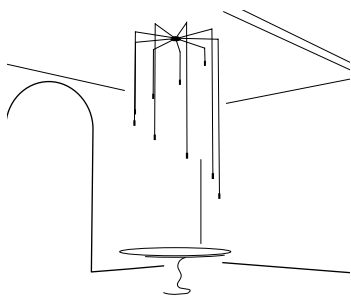

Wireflow FreeForm

Pendants

0345

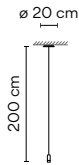

Light Source

 1 x LED 4,5W 350mA.
LED 2700 K. CRI >80. 490 lm. 109 lm/W.
Driver Constant Current 350mA.
100-240V. 50/60Hz.
Dimming: 1-10V, Push.

Pressed-glass diffuser.

Personalization options available

- Configuration layout at vibia.com
- LED 3000 K / 4000 K.
- Dimming: DALI or Casambi.

Min. quantity, upcharge and extra lead time apply.

Materials

Diffuser: Pressed-glass.
Body: Aluminum.
Canopy: Steel.

Packaging

1 Box.
0,25 x 0,42 x 0,42 m.
Vol. 0,0441 m³.
Gross weight 2,6 Kg.
Net weight 2,34 Kg.

0345 04 /1B Black
(RAL 9005)



0347

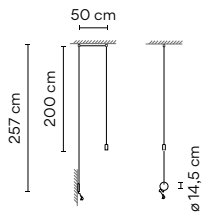

Light Source

 1 x LED 4,5W 350mA.
LED 2700 K. CRI >80. 490 lm. 109 lm/W.
Driver Constant Current 350mA.
100-240V. 50/60Hz.
Dimming: Push.

With plug.
Dimmer push button on the wall plate.
Without pressed-glass diffuser.

Personalization options available

- Configuration layout at vibia.com
- LED 3000 K / 4000 K.

Min. quantity, upcharge and extra lead time apply.

Materials

Diffuser: Polycarbonate.
Body: Aluminum.
Canopy: Steel.

Packaging

1 Box.
0,13 x 0,20 x 0,20 m.
Vol. 0,0055 m³.
Gross weight 1,5 Kg.
Net weight 1,35 Kg.

0347 04 /15 Black
(RAL 9005)



0348

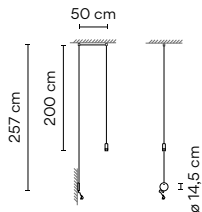

Light Source

 1 x LED 4,5W 350mA.
LED 2700 K. CRI >80. 490 lm. 109 lm/W.
Driver Constant Current 350mA.
100-240V. 50/60Hz.
Dimming: Push.

With plug.
Dimmer push button on the wall plate.
Pressed-glass diffuser.

Personalization options available

- Configuration layout at vibia.com
- LED 3000 K / 4000 K.

Min. quantity, upcharge and extra lead time apply.

Materials

Diffuser: Pressed-glass.
Body: Aluminum.
Canopy: Steel.

Packaging

1 Box.
0,26 x 0,26 x 0,26 m.
Vol. 0,0175 m³.
Gross weight 1,9 Kg.
Net weight 1,71 Kg.

0348 04 /15 Black
(RAL 9005)

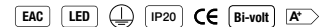

0349

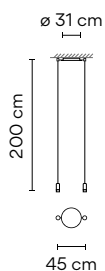

Light Source

 2x LED 4,5W 350mA.
LED 2700 K. CRI >80. 980 lm. 109 lm/W.
Driver Constant Current 350mA.
100-240V. 50/60Hz.
Dimming: DALI, 1-10V, Push.

Pressed-glass diffuser.

Personalization options available

- Configuration layout at vibia.com
- LED 3000 K / 4000 K.
- Dimming: Casambi.

Min. quantity, upcharge and extra lead time apply.

Materials

Diffuser: Pressed-glass.
Body: Aluminum.
Canopy: Steel.

Packaging

1 Box.
0,27 x 0,60 x 0,60 m.
Vol. 0,0972 m³.
Gross weight 4,6 Kg.
Net weight 4,14 Kg.

0349 04 /1A Black
(RAL 9005)



Wireflow FreeForm

0350

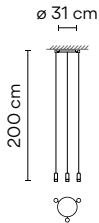

Light Source

3 x LED 4,5W 350mA.
LED 2700 K. CRI >80. 1471 lm. 109 lm/W.
Driver Constant Current 350mA.
 100-240V. 50/60Hz.
Dimming: DALI, 1-10V, Push.

Pressed-glass diffuser.

Personalization options available

- Configuration layout at vibia.com
 - LED 3000 K / 4000 K.
 - Dimming: Casambi.
- Min. quantity, upcharge and extra lead time apply.

Materials

Diffuser: Pressed-glass.
 Body: Aluminum.
 Canopy: Steel.

Packaging

1 Box.
 0,27 x 0,60 x 0,60 m.
 Vol. 0,0972 m³.
 Gross weight 5,2 Kg.
 Net weight 4,68 Kg.

0350 04 /1A Black
 (RAL 9005)



0351

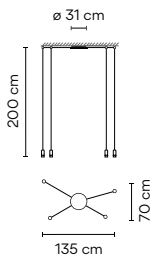

Light Source

4 x LED 4,5W 350mA.
LED 2700 K. CRI >80. 1961 lm. 109 lm/W.
Driver Constant Current 350mA.
 100-240V. 50/60Hz.
Dimming: DALI, 1-10V, Push.

Pressed-glass diffuser.

Personalization options available

- Configuration layout at vibia.com
 - LED 3000 K / 4000 K.
 - Dimming: Casambi.
- Min. quantity, upcharge and extra lead time apply.

Materials

Diffuser: Pressed-glass.
 Body: Aluminum.
 Canopy: Steel.

Packaging

1 Box.
 0,27 x 0,60 x 0,60 m.
 Vol. 0,0972 m³.
 Gross weight 5,6 Kg.
 Net weight 5,04 Kg.

0351 04 /1A Black
 (RAL 9005)



0353

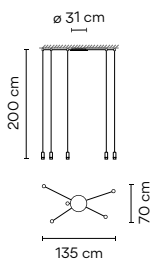

Light Source

5 x LED 4,5W 350mA.
LED 2700 K. CRI >80. 2451 lm. 109 lm/W.
Driver Constant Current 350mA.
 100-240V. 50/60Hz.
Dimming: DALI, 1-10V, Push.

Pressed-glass diffuser.

Personalization options available

- Configuration layout at vibia.com
 - LED 3000 K / 4000 K.
 - Dimming: Casambi.
- Min. quantity, upcharge and extra lead time apply.

Materials

Diffuser: Pressed-glass.
 Body: Aluminum.
 Canopy: Steel.

Packaging

1 Box.
 0,27 x 0,60 x 0,60 m.
 Vol. 0,0972 m³.
 Gross weight 6,1 Kg.
 Net weight 5,49 Kg.

0353 04 /1A Black
 (RAL 9005)



0355

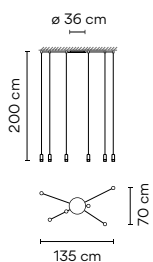

Light Source

6x LED 4,5W 350mA.
LED 2700 K. CRI >80. 2942 lm. 109 lm/W.
Driver Constant Current 350mA.
 100-240V. 50/60Hz.
Dimming: DALI, 1-10V, Push.

Pressed-glass diffuser.

Personalization options available

- Configuration layout at vibia.com
 - LED 3000 K / 4000 K.
 - Dimming: Casambi.
- Min. quantity, upcharge and extra lead time apply.

Materials

Diffuser: Pressed-glass.
 Body: Aluminum.
 Canopy: Steel.

Packaging

1 Box.
 0,27 x 0,60 x 0,60 m.
 Vol. 0,0972 m³.
 Gross weight 6,7 Kg.
 Net weight 6,03 Kg.

0355 04 /1A Black
 (RAL 9005)

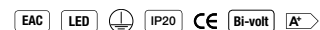

Wireflow FreeForm

0356

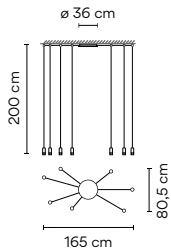

Light Source

7x LED 4,5W 350mA.
LED 2700 K. CRI >80. 3432 lm. 109 lm/W.
Driver Constant Current 350mA.
 100-240V. 50/60Hz.
Dimming: DALI, 1-10V, Push.

Pressed-glass diffuser.

Personalization options available

- Configuration layout at vibia.com
 - LED 3000 K / 4000 K.
 - Dimming: Casambi.
- Min. quantity, upcharge and extra lead time apply.

Materials

Diffuser: Pressed-glass.
 Body: Aluminum.
 Canopy: Steel.

Packaging

1 Box.
 0,27 x 0,60 x 0,60 m.
 Vol. 0,0972 m³.
 Gross weight 7,9 Kg.
 Net weight 7,11 Kg.

0356 04 /1A Black

(RAL 9005)

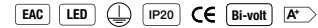

0358

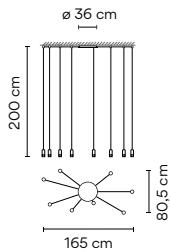

Light Source

8x LED 4,5W 350mA.
LED 2700 K. CRI >80. 3922 lm. 109 lm/W.
Driver Constant Current 350mA.
 100-240V. 50/60Hz.
Dimming: DALI, 1-10V, Push.

Pressed-glass diffuser.

Personalization options available

- Configuration layout at vibia.com
 - LED 3000 K / 4000 K.
 - Dimming: Casambi.
- Min. quantity, upcharge and extra lead time apply.

Materials

Diffuser: Pressed-glass.
 Body: Aluminum.
 Canopy: Steel.

Packaging

1 Box.
 0,27 x 0,60 x 0,60 m.
 Vol. 0,0972 m³.
 Gross weight 8,4 Kg.
 Net weight 7,56 Kg.

0358 04 /1A Black

(RAL 9005)



0360

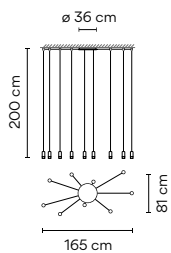

Light Source

9x LED 4,5W 350mA.
LED 2700 K. CRI >80. 4412 lm. 109 lm/W.
Driver Constant Current 350mA.
 100-240V. 50/60Hz.
Dimming: DALI, 1-10V, Push.

Pressed-glass diffuser.

Personalization options available

- Configuration layout at vibia.com
 - LED 3000 K / 4000 K.
 - Dimming: Casambi.
- Min. quantity, upcharge and extra lead time apply.

Materials

Diffuser: Pressed-glass.
 Body: Aluminum.
 Canopy: Steel.

Packaging

1 Box.
 0,27 x 0,60 x 0,60 m.
 Vol. 0,0972 m³.
 Gross weight 9,1 Kg.
 Net weight 8,19 Kg.

0360 04 /1A Black

(RAL 9005)



0361

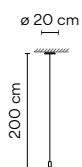

Light Source

1x LED 4,5W 350mA.
LED 2700 K. CRI >80. 490 lm. 109 lm/W.
Driver Constant Current 350mA.
 100-240V. 50/60Hz.
Dimming: 1-10V, Push.

Without pressed-glass diffuser.

Personalization options available

- Configuration layout at vibia.com
 - LED 3000 K / 4000 K.
 - Dimming: DALI or Casambi.
- Min. quantity, upcharge and extra lead time apply.

Materials

Diffuser: Polycarbonate.
 Body: Aluminum.
 Canopy: Steel.

Packaging

1 Box.
 0,25 x 0,42 x 0,42 m.
 Vol. 0,0441 m³.
 Gross weight 2,6 Kg.
 Net weight 2,34 Kg.

0361 04 /1B Black

(RAL 9005)



Wireflow FreeForm

0362

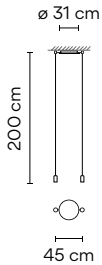

Light Source

2x LED 4,5W 350mA.
LED 2700 K. CRI >80. 980 lm. 109 lm/W.
Driver Constant Current 350mA.
100-240V. 50/60Hz.
Dimming: DALI, 1-10V, Push.

Without pressed-glass diffuser.

Personalization options available

- Configuration layout at vibia.com
 - LED 3000 K / 4000 K.
 - Dimming: Casambi.
- Min. quantity, upcharge and extra lead time apply.

Materials

Diffuser: Polycarbonate.
Body: Aluminum.
Canopy: Steel.

Packaging

1 Box.
0,27 x 0,60 x 0,60 m.
Vol. 0,0972 m³.
Gross weight 4,6 Kg.
Net weight 4,14 Kg.

0362 04 /1A Black
(RAL 9005)



0363

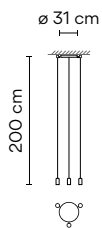

Light Source

3x LED 4,5W 350mA.
LED 2700 K. CRI >80. 1471 lm. 109 lm/W.
Driver Constant Current 350mA.
100-240V. 50/60Hz.
Dimming: DALI, 1-10V, Push.

Without pressed-glass diffuser.

Personalization options available

- Configuration layout at vibia.com
 - LED 3000 K / 4000 K.
 - Dimming: Casambi.
- Min. quantity, upcharge and extra lead time apply.

Materials

Diffuser: Polycarbonate.
Body: Aluminum.
Canopy: Steel.

Packaging

1 Box.
0,27 x 0,60 x 0,60 m.
Vol. 0,0972 m³.
Gross weight 5,2 Kg.
Net weight 4,68 Kg.

0363 04 /1A Black
(RAL 9005)



0364

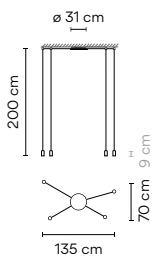

Light Source

4x LED 4,5W 350mA.
LED 2700 K. CRI >80. 1471 lm. 109 lm/W.
Driver Constant Current 350mA.
100-240V. 50/60Hz.
Dimming: DALI, 1-10V, Push.

Without pressed-glass diffuser.

Personalization options available

- Configuration layout at vibia.com
 - LED 3000 K / 4000 K.
 - Dimming: Casambi.
- Min. quantity, upcharge and extra lead time apply.

Materials

Diffuser: Polycarbonate.
Body: Aluminum.
Canopy: Steel.

Packaging

1 Box.
0,27 x 0,60 x 0,60 m.
Vol. 0,0972 m³.
Gross weight 5,6 Kg.
Net weight 5,04 Kg.

0364 04 /1A Black
(RAL 9005)

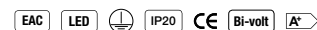

0365

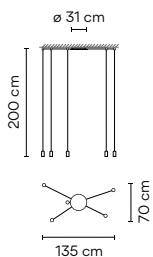

Light Source

5x LED 4,5W 350mA.
LED 2700 K. CRI >80. 2451 lm. 109 lm/W.
Driver Constant Current 350mA.
100-240V. 50/60Hz.
Dimming: DALI, 1-10V, Push.

Without pressed-glass diffuser.

Personalization options available

- Configuration layout at vibia.com
 - LED 3000 K / 4000 K.
 - Dimming: Casambi.
- Min. quantity, upcharge and extra lead time apply.

Materials

Diffuser: Polycarbonate.
Body: Aluminum.
Canopy: Steel.

Packaging

1 Box.
0,27 x 0,60 x 0,60 m.
Vol. 0,0972 m³.
Gross weight 5,04 Kg.
Net weight 5,49 Kg.

0365 04 /1A Black
(RAL 9005)



Wireflow FreeForm

0366

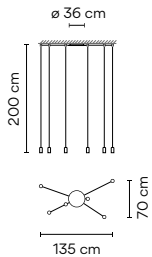

Light Source

6x LED 4,5W 350mA.
LED 2700 K. CRI >80. 2942 lm. 109 lm/W.
Driver Constant Current 350mA.
100-240V. 50/60Hz.
Dimming: DALI, 1-10V, Push.

Without pressed-glass diffuser.

Personalization options available

- Configuration layout at vibia.com
- LED 3000 K / 4000 K.
- Dimming: Casambi.
Min. quantity, upcharge and extra lead time apply.

Materials

Diffuser: Polycarbonate.
Body: Aluminum.
Canopy: Steel.

Packaging

1 Box.
0,27 x 0,60 x 0,60 m.
Vol. 0,0972 m³.
Gross weight 6,7 Kg.
Net weight 6,03 Kg

0366 04 /1A Black
(RAL 9005)



0367

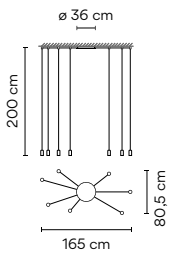

Light Source

7x LED 4,5W 350mA.
LED 2700 K. CRI >80. 3432 lm. 109 lm/W.
Driver Constant Current 350mA.
100-240V. 50/60Hz.
Dimming: DALI, 1-10V, Push.

Without pressed-glass diffuser.

Personalization options available

- Configuration layout at vibia.com
- LED 3000 K / 4000 K.
- Dimming: Casambi.
Min. quantity, upcharge and extra lead time apply.

Materials

Diffuser: Polycarbonate.
Body: Aluminum.
Canopy: Steel.

Packaging

1 Box.
0,27 x 0,60 x 0,60 m.
Vol. 0,0972 m³.
Gross weight 7,9 Kg.
Net weight 7,11 Kg

0367 04 /1A Black
(RAL 9005)



0368

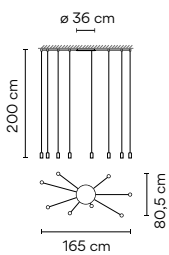

Light Source

8x LED 4,5W 350mA.
LED 2700 K. CRI >80. 3922 lm. 109 lm/W.
Driver Constant Current 350mA.
100-240V. 50/60Hz.
Dimming: DALI, 1-10V, Push.

Without pressed-glass diffuser.

Personalization options available

- Configuration layout at vibia.com
- LED 3000 K / 4000 K.
- Dimming: Casambi.
Min. quantity, upcharge and extra lead time apply.

Materials

Diffuser: Polycarbonate.
Body: Aluminum.
Canopy: Steel.

Packaging

1 Box.
0,27 x 0,60 x 0,60 m.
Vol. 0,0972 m³.
Gross weight 8,4 Kg.
Net weight 7,56 Kg

0368 04 /1A Black
(RAL 9005)



0369

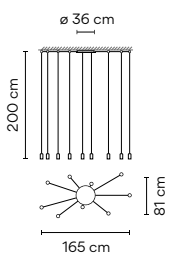

Light Source

9x LED 4,5W 350mA.
LED 2700 K. CRI >80. 4412 lm. 109 lm/W.
Driver Constant Current 350mA.
100-240V. 50/60Hz.
Dimming: DALI, 1-10V, Push.

Without pressed-glass diffuser.

Personalization options available

- Configuration layout at vibia.com
- LED 3000 K / 4000 K.
- Dimming: Casambi.
Min. quantity, upcharge and extra lead time apply.

Materials

Diffuser: Polycarbonate.
Body: Aluminum.
Canopy: Steel.

Packaging

1 Box.
0,27 x 0,60 x 0,60 m.
Vol. 0,0972 m³.
Gross weight 9,1 Kg.
Net weight 8,19 Kg

0369 04 /1A Black
(RAL 9005)

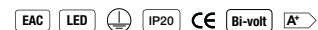

Wireflow Chandelier

Design by Arik Levy

Wireflow is a collection of hanging lights that are at once presence and absence. Featuring slender black, electrical cables tipped with LED light terminals, its three-dimensional forms represent a contemporary reinterpretation of the traditional chandelier.



Create your product configuration quickly and easily at vibia.com

Go to vibia.com and discover the quickest, most effective way to configure a unique Wireflow design.

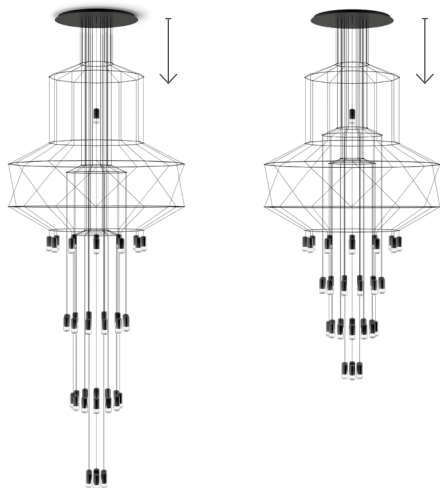

For configurations longer than 9 m, please ask Vibia customer service.

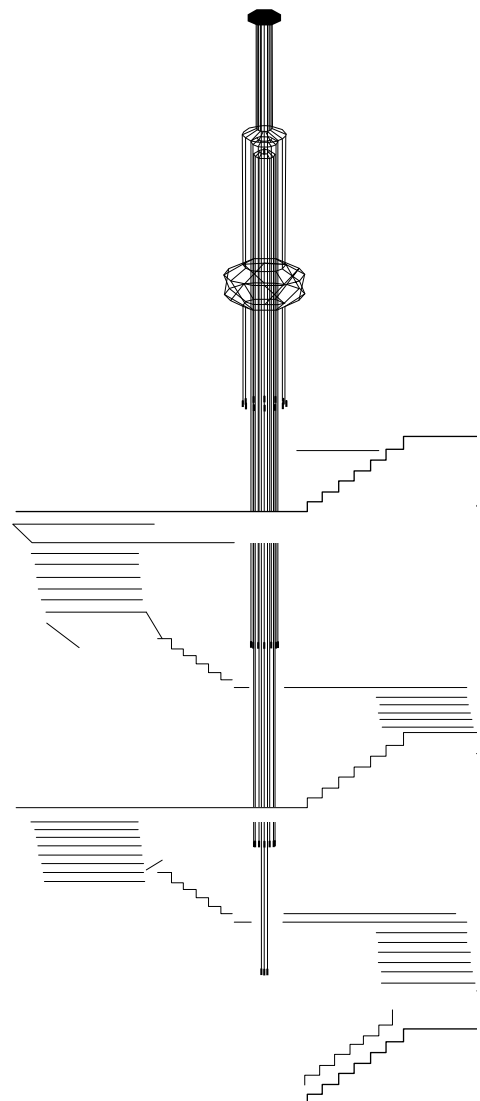

Wireflow Chandelier

Pendants

0315

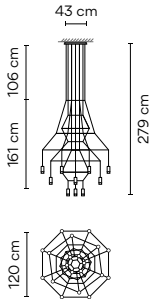

Light Source

20 x LED 4,5W 700mA.
LED 2700 K. CRI >80. 9805 lm. 109 lm/W.
Driver Constant Current 700mA.
 100-240V. 50/60Hz.
Dimming: DALI, 1-10, Push.

Personalization options available

- Configuration layout at vibia.com
 - LED 3000 K / 4000 K.
 - Dimming: Casambi.
 Min. quantity, upcharge and extra lead time apply.

Materials

Diffuser: Pressed-glass.
 Body: Aluminum.
 Canopy and horizontal rods: Steel.

Packaging

2 Boxes.
 Total vol. 0,3832 m³.
 Gross weight 32 Kg.
 Net weight 18 Kg.

0315 04 /1A Black
 (RAL 9005)



0374

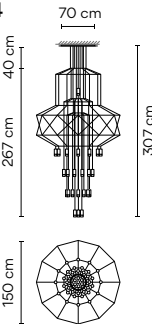

Light Source

43 x LED 4,5W 700mA.
LED 2700 K. CRI >80. 21082 lm. 109 lm/W.
Driver Constant Current 700mA.
 100-240V. 50/60Hz.
Dimming: DALI, 1-10, Push.

Personalization options available

- Configuration layout at vibia.com
 - LED 3000 K / 4000 K.
 - Dimming: Casambi.
 Min. quantity, upcharge and extra lead time apply.

Materials

Diffuser: Pressed-glass.
 Body: Aluminum.
 Canopy and horizontal rods: Steel.

Packaging

2 Boxes.
 Total vol. 0,5000 m³.
 Gross weight 57 Kg.
 Net weight 47 Kg.

0374 04 /1A Black
 (RAL 9005)



0375

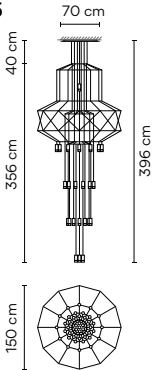

Light Source

43 x LED 4,5W 700mA.
LED 2700 K. CRI >80. 21082 lm. 109 lm/W.
Driver Constant Current 700mA.
 100-240V. 50/60Hz.
Dimming: DALI, 1-10, Push.

Personalization options available

- Configuration layout at vibia.com
 - LED 3000 K / 4000 K.
 - Dimming: Casambi.
 Min. quantity, upcharge and extra lead time apply.

Materials

Diffuser: Pressed-glass.
 Body: Aluminum.
 Canopy and horizontal rods: Steel.

Packaging

2 Boxes
 Total vol. 0,5000 m³.
 Gross weight 57 Kg.
 Net weight 47 Kg.

0375 04 /1A Black
 (RAL 9005)



0376

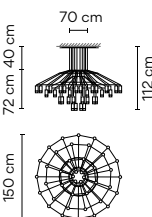

Light Source

42 x LED 4,5W 700mA.
LED 2700 K. CRI >80. 20591 lm. 109 lm/W.
Driver Constant Current 700mA.
 100-240V. 50/60Hz.
Dimming: DALI, 1-10, Push.

Personalization options available

- Configuration layout at vibia.com
 - LED 3000 K / 4000 K.
 - Dimming: Casambi.
 Min. quantity, upcharge and extra lead time apply.

Materials

Diffuser: Pressed-glass.
 Body: Aluminum.
 Canopy and horizontal rods: Steel.

Packaging

2 Boxes.
 Total vol. 0,5000 m³.
 Gross weight 56 Kg.
 Net weight 46 Kg.

0376 04 /1A Black
 (RAL 9005)



Wireflow Chandelier

0377

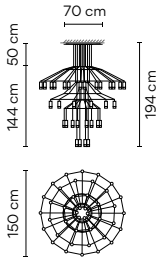

Light Source

Ⓟ
 42 x LED 4,5W 700mA.
 LED 2700 K. CRI >80. 20591 lm. 109 lm/W.
 Driver Constant Current 700mA.
 100-240V. 50/60Hz.
 Dimming: DALI, 1-10, Push.

Personalization options available

- Configuration layout at vibia.com
 - LED 3000 K / 4000 K.
 - Dimming: Casambi.
 Min. quantity, upcharge and extra lead time apply.

Materials

Diffuser: Pressed-glass.
 Body: Aluminum.
 Canopy and horizontal rods: Steel.

Packaging

2 Boxes.
 Total vol. 0,5000 m³.
 Gross weight 56 Kg.
 Net weight 46 Kg.

0377 04 /1A Black
 (RAL 9005)



0378

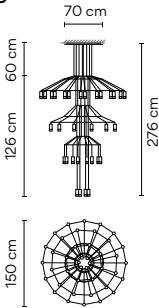

Light Source

Ⓟ
 42 x LED 4,5W 700mA.
 LED 2700 K. CRI >80. 20591 lm. 109 lm/W.
 Driver Constant Current 700mA.
 100-240V. 50/60Hz.
 Dimming: DALI, 1-10, Push.

Personalization options available

- Configuration layout at vibia.com
 - LED 3000 K / 4000 K.
 - Dimming: Casambi.
 Min. quantity, upcharge and extra lead time apply.

Materials

Diffuser: Pressed-glass.
 Body: Aluminum.
 Canopy and horizontal rods: Steel.

Packaging

2 Boxes.
 Total vol. 0,5000 m³.
 Gross weight 56 Kg.
 Net weight 46 Kg.

0378 04 /1A Black
 (RAL 9005)



Swing

Design by Lievore, Altherr, Molina

Simple and timeless in sensibility, Swing features a traditional design with a distinctive articulated arm that offers 180 degrees in motion.



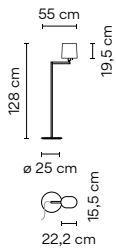

Floor

0503



Light Source

 Or  Or 
 1 x Core Pro LEDbulb E27 230V 9W.
 Or
 1 x COMPACT FLUORESCENT
 E27 230V 15W Max.
 Or
 1 x E27 230V 70W Eco Max.

Switch on the lampholder.
Electric cable 2,5 m.

Personalization options available
 - Finish customization.
 (Available options: Vibia color palette).
 Min. quantity, upcharge and extra lead time apply.

Materials

Shade: Screen.
Vertical tube: Steel.
Base: Steel.

Packaging

1 Box.
1,7 x 0,36 x 0,38 m.
Vol. 0,2325 m³.
Gross weight 10,2 Kg.
Net weight 9,18 Kg.

0503 01 Chrome
(Metallic finish).

0503 18 Graphite
(RAL 7016).

0503 93 White
(RAL 9016).



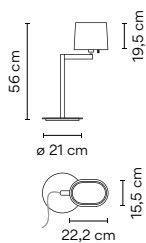

Table

0507



Light Source

 Or  Or 
 1 x Core Pro LEDbulb E27 230V 9W.
 Or
 1 x COMPACT FLUORESCENT
 E27 230V 15W Max.
 Or
 1 x E27 230V 70W Eco Max.

Switch on the lampholder.
Electric cable 2,5 m.

Personalization options available
 - Finish customization.
 (Available options: Vibia color palette).
 Min. quantity, upcharge and extra lead time apply.

Materials

Shade: Screen.
Vertical tube: Steel.
Base: Steel.

Packaging

1 Box.
0,27 x 0,60 x 0,60 m.
Vol. 0,0972 m³.
Gross weight 6,3 Kg.
Net weight 4,3 Kg.

0507 01 Chrome
(Metallic finish).

0507 18 Graphite
(RAL 7016).

0507 93 White
(RAL 9016).



Swing

Wall

0509

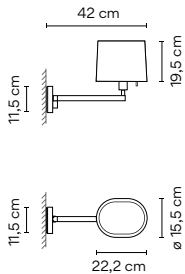

Light Source

Or Or
 1 x Core Pro LEDbulb E27 230V 9W.
 Or
 1 x COMPACT FLUORESCENT E27 230V 15W Max.
 Or
 1 x E27 230V 70W Eco Max.

Switch on the lampholder.

Personalization options available

- Finish customization.
 (Available options: Vibia color palette).
 Min. quantity, upcharge and extra lead time apply.

Materials

Horizontal tube: Steel.
 Shade: Screen.
 Wall plate: Aluminum.

Packaging

2 Boxes.
 Total vol. 0,353 m³.
 Gross weight 2,21 Kg.
 Net weight 1,5 Kg.

0509 01 Chrome
 (Metallic finish).

0509 18 Graphite
 (RAL 7016).

0509 93 White
 (RAL 9016).



0514

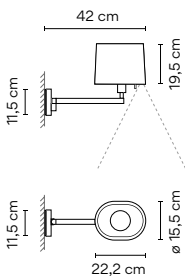

Light Source

Or Or
 1 x Core Pro LEDbulb E27 230V 9W.
 Or
 1 x COMPACT FLUORESCENT E27 230V 15W Max.
 Or
 1 x E27 230V 70W Eco Max.
 And
 1 x LED 2,1W 700mA.
LED 2700 K. CRI >80. 413,72 lm. 95 lm/W.
Driver Constant Current 700mA.
 100-240V. 50/60Hz.

Switch on the diffuser/ under the shade.
 Double switch: general light and LED reading light.

Personalization options available

- Finish customization.
 (Available options: Vibia color palette).
 Min. quantity, upcharge and extra lead time apply.

Materials

Horizontal tube: Steel.
 Diffuser: Methacrylate.
 Shade: Screen.
 Wall plate: Aluminum.

Packaging

2 Boxes.
 Total vol. 0,0442 m³.
 Gross weight 2,21 Kg.
 Net weight 1 Kg.

0514 01 /10 Chrome
 (Metallic finish).

0514 18 /10 Graphite
 (RAL 7016).

0514 93 /10 White
 (RAL 9016).



Big

Design by Lievore, Altherr, Molina

Big breaks new ground in terms of scale and technology, revolutionising the ceiling light fitting.



Easy-to-install and replace bulb system.

Ceiling

0530

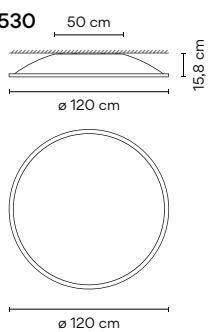

Light Source

2 x 2G11 230V 36W.
2 x 2G11 230V 24W.
Dimming: DALI, Push.

Easy-to-install and replace bulb system.

Personalization options available
- Finish customization.
(Available options: Vibia color palette).
Min. quantity, upcharge and extra lead time apply.

Materials

Shade: Aluminum.
Diffuser: Methacrylate.
Ring: Steel.

Packaging

1 Box.
0,38 x 1,37 x 1,37 m.
Vol. 0,7080 m³.
Gross weight 21 Kg.
Net weight 18,9 Kg.

0530 01 Chrome
(Metallic finish).

0530 93 White
(RAL 9010).



0531

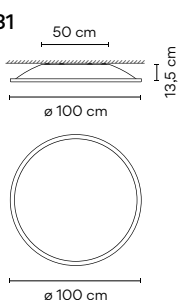

Light Source

2 x 2G11 230V 36W.
2 x 2G11 230V 24W.
Dimming: DALI, Push.

Easy-to-install and replace bulb system.

Personalization options available
- Finish customization.
(Available options: Vibia color palette).
Min. quantity, upcharge and extra lead time apply.

Materials

Shade: Aluminum.
Diffuser: Methacrylate.
Ring: Steel.

Packaging

1 Box.
0,34 x 1,14 x 1,14 m.
Vol. 0,4420 m³.
Gross weight 15,2 Kg.
Net weight 13,68 Kg.

0531 01 Chrome
(Metallic finish).

0531 93 White
(RAL 9010).

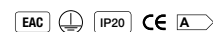

0532

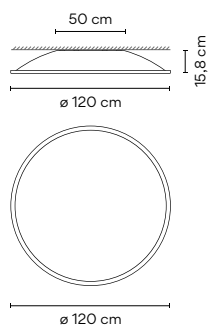

Light Source

4 x LED Quadrant 18,9W 500mA.
 / **2B:** **A**⁺
LED 3000 K. CRI >90. 8944 lm. 132 lm/W.
 / **4B:** **A**⁺⁺
LED 4000 K. CRI >80. 9544 lm. 141 lm/W.
Driver Constant Current 500mA.
 220-240V. 50/60Hz.
Dimming: 1-10V, Push.

Personalization options available

- Finish customization.
 (Available options: Vibia color palette).
 - Dimming: DALI or Casambi.
 Min. quantity, upcharge and extra lead time apply.

Materials

Shade: Aluminum.
 Diffuser: Methacrylate.
 Ring: Steel.

Packaging

1 Box.
 0,38 x 1,36 x 1,36 m.
 Vol. 0,7080 m³.
 Gross weight 21 Kg.
 Net weight 18,9 Kg.

0532 01 /2B Chrome
 (Metallic finish)

0532 01 /4B Chrome
 (Metallic finish)

0532 93 /2B White
 (RAL 9010)

0532 93 /4B White
 (RAL 9010)



0533

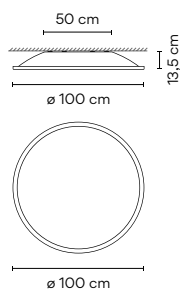

Light Source

4 x LED Quadrant 18,9W 500mA.
 / **2B:** **A**⁺
LED 3000 K. CRI >90. 8944 lm. 132 lm/W.
 / **4B:** **A**⁺⁺
LED 4000 K. CRI >80. 9544 lm. 141 lm/W.
Driver Constant Current 500mA.
 220-240V. 50/60Hz.
Dimming: 1-10V, Push.

Personalization options available

- Finish customization.
 (Available options: Vibia color palette).
 - Dimming: DALI or Casambi.
 Min. quantity, upcharge and extra lead time apply.

Materials

Shade: Aluminum.
 Diffuser: Methacrylate.
 Ring: Steel.

Packaging

1 Box.
 0,34 x 1,14 x 1,14 m.
 Vol. 0,4420 m³.
 Gross weight 15,2 Kg.
 Net weight 13,68 Kg.

0533 01 /2B Chrome
 (Metallic finish)

0533 01 /4B Chrome
 (Metallic finish)

0533 93 /2B White
 (RAL 9010)

0533 93 /4B White
 (RAL 9010)



Pendants

0535

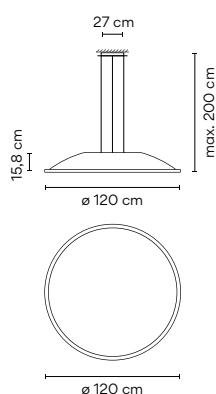

Light Source

2 x 2G11 230V 36W.
 2 x 2G11 230V 24W.
Dimming: DALI, Push.

Easy-to-install and replace bulb system.

Personalization options available

- Finish customization.
 (Available options: Vibia color palette).
 - Extra cable length.
 Min. quantity, upcharge and extra lead time apply.

Materials

Shade: Aluminum.
 Diffuser: Methacrylate.
 Ring: Steel.
 Canopy: Steel.

Packaging

1 Box.
 0,38 x 1,37 x 1,37 m.
 Vol. 0,7080 m³.
 Gross weight 25,6 Kg.
 Net weight 23,04 Kg.

0535 01 Chrome
 (Metallic finish).

0535 93 White
 (RAL 9010).

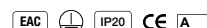

0536

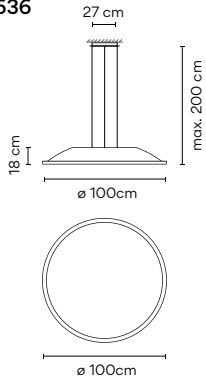

Light Source



2 x 2G11 230V 36W.
2 x 2G11 230V 24W.
Dimming: DALI, Push.

Easy-to-install and replace bulb system.

Personalization options available

- Finish customization.
(Available options: Vibia color palette).
 - Extra cable length.
- Min. quantity, upcharge and extra lead time apply.

Materials

Shade: Aluminum.
Diffuser: Methacrylate.
Ring: Steel.
Canopy: Steel.

Packaging

1 Box.
0,34 x 1,14 x 1,14 m.
Vol. 0,4420 m³.
Gross weight 19,6 Kg.
Net weight 17,64 Kg.

0536 01 Chrome
(Metallic finish).

0536 93 White
(RAL 9010).



0537

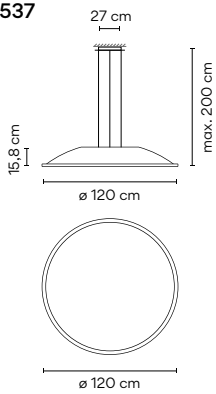

Light Source



4 x LED Quadrant 18,9W 500mA.
/ **2B:**
LED 3000 K. CRI >90. 8944 lm.132 lm/W.
/ **4B:**
LED 4000 K. CRI >80. 9544 lm. 141 lm/W.
Driver Constant Current 500mA.
220-240V. 50/60Hz.
Dimming: 1-10V, Push.

Personalization options available

- Finish customization.
(Available options: Vibia color palette).
 - Dimming: DALI or Casambi.
 - Extra cable length.
- Min. quantity, upcharge and extra lead time apply.

Materials

Shade: Aluminum.
Diffuser: Methacrylate.
Ring: Steel.
Canopy: Steel.

Packaging

1 Box.
0,38 x 1,36 x 1,36 m.
Vol. 0,7080 m³.
Gross weight 25,6 Kg.
Net weight 23,04 Kg.

0537 01 /2B Chrome
(Metallic finish)

0537 01 /4B Chrome
(Metallic finish)

0537 93 /2B White
(RAL 9010)

0537 93 /4B White
(RAL 9010)



0538

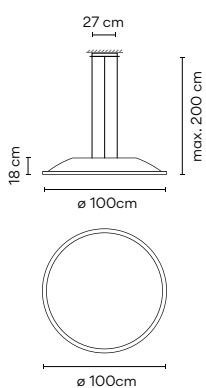

Light Source



4 x LED Quadrant 18,9W 500mA.
/ **2B:**
LED 3000 K. CRI >90. 8944 lm.132 lm/W.
/ **4B:**
LED 4000 K. CRI >80. 9544 lm. 141 lm/W.
Driver Constant Current 500mA.
220-240V. 50/60Hz.
Dimming: 1-10V, Push.

Personalization options available

- Finish customization.
(Available options: Vibia color palette).
 - Dimming: DALI or Casambi.
 - Extra cable length.
- Min. quantity, upcharge and extra lead time apply.

Materials

Shade: Aluminum.
Diffuser: Methacrylate.
Ring: Steel.
Canopy: Steel.

Packaging

1 Box.
0,38 x 1,36 x 1,36 m.
Vol. 0,7080 m³.
Gross weight 19,6 Kg.
Net weight 17,64 Kg.

0538 01 /2B Chrome
(Metallic finish)

0538 01 /4B Chrome
(Metallic finish)

0538 93 /2B White
(RAL 9010)

0538 93 /4B White
(RAL 9010)



Big Built-in

Design by Lievore, Altherr, Molina

Big reimagines the utilitarian ceiling light with an enlarged diffuser that covers nearly the entire chrome fitting. The simple, oversized shape evokes a glowing orb overhead, its pure, geometric silhouette mimicking the effect of a skylight.



Chrome ring.
Easy-to-install and
replace bulb system.

Ceiling

0540

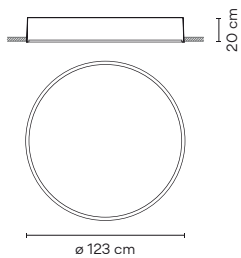

Light Source

2 x G5 230V 24W (T5).
2 x G5 230V 39W (T5).
2 x G5 230V 54W (T5).

Dimming: DALI, Push.

Built-in.

Personalization options available

- Finish customization.
(Available options: Vibia color palette).
Min. quantity, upcharge and extra lead
time apply.

Materials

Diffuser: Methacrylate.
Built-in body: Aluminum.
Ring: Steel.

Packaging

1 Box.
0,38 x 1,37 x 1,37 m.
Vol. 0,7080 m³.
Gross weight 23 Kg.
Net weight 15 Kg.

0540 01 Chrome
(Metallic finish).

0540 93 White
(RAL 9010).



0543

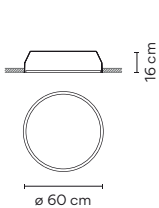

Light Source

2 x 2G11 230V 24W.
2 x 2G11 230V 36W.

Dimming: DALI, Push.

Built-in.

Personalization options available

- Finish customization.
(Available options: Vibia color palette).
Min. quantity, upcharge and extra lead
time apply.

Materials

Diffuser: Methacrylate.
Built-in body: Aluminum.
Ring: Steel.

Packaging

1 Box.
0,27 x 0,76 x 0,76 m.
Vol. 0,1550 m³.
Gross weight 7 Kg.
Net weight 4,50 Kg.

0543 01 Chrome
(Metallic finish).

0543 93 White
(RAL 9010).



Big Built-in

0544

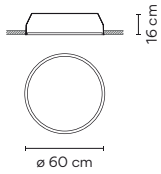

Light Source

 2 x 2G11 230V 24W.
 2 x 2G11 230V 36W.

Built-in.

Personalization options available

- Finish customization.
 (Available options: Vibia color palette).
 Min. quantity, upcharge and extra lead time apply.

Materials

Diffuser: Methacrylate.
 Built-in body: Aluminum.
 Ring: Steel.

Packaging

1 Box.
 0,27 x 0,76 x 0,76 m.
 Vol. 0,1550 m³.
 Gross weight 8 Kg.
 Net weight 5 Kg.

0544 01 Chrome
 (Metallic finish).

0544 93 White
 (RAL 9010).



0546

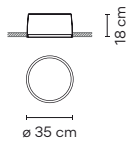

Light Source

 1 x 2GX13 230V 55W (T5C).
Dimming: DALI, Push.

Built-in.

Personalization options available

- Finish customization.
 (Available options: Vibia color palette).
 Min. quantity, upcharge and extra lead time apply.

Materials

Diffuser: Methacrylate.
 Built-in body: Aluminum.
 Ring: Steel.

Packaging

1 Box.
 0,25 x 0,42 x 0,42 m.
 Vol. 0,0440 m³.
 Gross weight 2,5 Kg.
 Net weight 2 Kg.

0546 01 Chrome
 (Metallic finish).

0546 93 White
 (RAL 9010).



0547

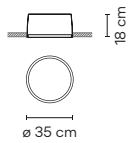

Light Source

 1 x 2GX13 230V 55W (T5C).

Built-in.

Personalization options available

- Finish customization.
 (Available options: Vibia color palette).
 Min. quantity, upcharge and extra lead time apply.

Materials

Diffuser: Methacrylate.
 Built-in body: Aluminum.
 Ring: Steel.

Packaging

1 Box.
 0,25 x 0,42 x 0,42 m.
 Vol. 0,0440 m³.
 Gross weight 2,5 Kg.
 Net weight 2 Kg.

0547 01 Chrome
 (Metallic finish).

0547 93 White
 (RAL 9010).



Plus

Design by X. Claramunt & M. de Mas

Adopting the form and function of a skylight, Plus' streamlined, spherical design integrates seamlessly into the ceiling architecture. Its diffuser lends the dimmable light an ambient, uniform quality.



Easy-to-install-
and replace bulb system.

Ceiling

0605

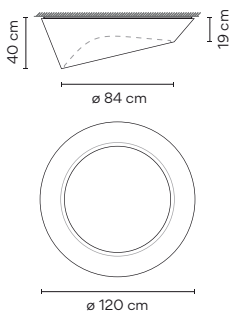

Light Source

2 x G5 230V 24W (T5).
4 x G5 230V 39W (T5).
Dimming: DALI, Push.

Easy-to-install and replace bulb system.

Materials

Body: Polyurethane foam.
Ceiling support: Steel.
Diffuser: Methacrylate.

Packaging

1 Box.
0,49 x 1,37 x 1,37 m.
Vol. 0,9129 m³.
Gross weight 37,6 Kg.
Net weight 33,89 Kg.

0605 03 White
(RAL 9010)

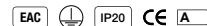

0607

New

Light Source



6 x LED PLATE 20W 1050mA.
/ 2A: .
LED 3000 K. CRI>90. 13465 lm. 112 lm/W.
/ 4A: .
LED 4000 K. CRI>80. 14214 lm. 118 lm/W.
Driver Constant Current 1050mA.
110-240V. 50/60Hz.
Dimming: DALI, 1-10V, Push.

Personalization options available

- Dimming: Casambi.
Min. quantity, upcharge and extra lead
time apply.

Materials

Body: Polyurethane foam.
Ceiling support: Steel.
Diffuser: Methacrylate.

Packaging

1 Box.
0,49 x 1,37 x 1,37 m.
Vol. 0,9129 m³.
Gross weight 37,6 Kg.
Net weight 33,89 Kg.

0607 03/2A White
(RAL 9016)

0607 03/4A White
(RAL 9016)



0615

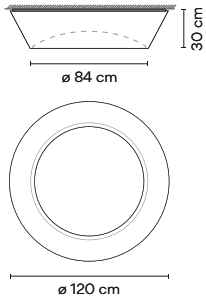

Light Source

2 x G5 230V 24W (T5).
4 x G5 230V 39W (T5).
Dimming: DALI, Push.

Easy-to-install and replace bulb system.

Materials

Body: Polyurethane foam.
Ceiling support: Steel.
Diffuser: Methacrylate.

Packaging

1 Box.
0,38 x 1,37 x 1,37 m.
Vol. 0,7080 m³.
Gross weight 32,5 Kg
Net weight: 29,25 Kg

0615 03 White
(RAL 9010)



0617

New

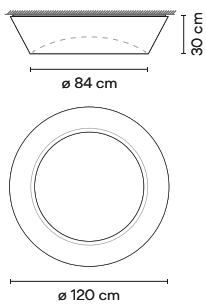

Light Source

6 x LED PLATE 20W 1050mA.
/ 2A: **LED** 3000 K. CRI>90. 13465 lm. 112 lm/W.
/ 4A: **LED** 4000 K. CRI>80. 14214 lm. 118 lm/W.
Driver Constant Current 1050mA.
110-240V. 50/60Hz.
Dimming: DALI, 1-10V, Push.

Personalization options available

- Dimming: Casambi.
Min. quantity, upcharge and extra lead time apply.

Materials

Body: Polyurethane foam.
Ceiling support: Steel.
Diffuser: Methacrylate.

Packaging

1 Box.
0,49 x 1,37 x 1,37 m.
Vol. 0,0913 m³.
Gross weight 37,6 Kg.
Net weight 33,89 Kg.

0617 03/2A White
(RAL 9016)

0617 03/4A White
(RAL 9016)



0620

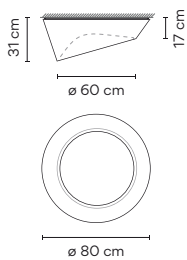

Light Source

4 x G5 230V 24W (T5).
Dimming: DALI, Push.

Easy-to-install and replace bulb system.

Materials

Body: Polyurethane foam.
Ceiling support: Steel.
Diffuser: Methacrylate.

Packaging

1 Box.
0,45 x 0,95 x 0,95 m.
Vol. 0,4151 m³.
Gross weight 16,8 Kg.
Net weight 15,12 Kg.

0620 03 White
(RAL 9010)



0622

New

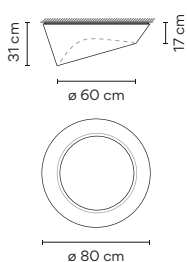

Light Source

4 x LED PLATE 20W 1050mA.
/ 2A: **LED** 3000 K. CRI>90. 2625 lm. 112 lm/W.
/ 4A: **LED** 4000 K. CRI>80. 10556 lm. 131 lm/W.
Driver Constant Current 1050mA.
110-240V. 50/60Hz.
Dimming: DALI, 1-10V, Push.

Personalization options available

- Dimming: Casambi.
Min. quantity, upcharge and extra lead time apply.

Materials

Body: Polyurethane foam.
Ceiling support: Steel.
Diffuser: Methacrylate.

Packaging

1 Box.
0,49 x 1,365 x 1,365 m.
Vol. 0,4151 m³.
Gross weight 16,8 Kg.
Net weight 15,12 Kg.

0622 03/2A White
(RAL 9016)

0622 03/4A White
(RAL 9016)



0625

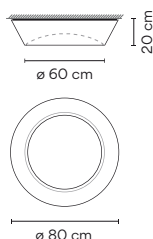

Light Source

4 x G5 230V 24W (T5).
Dimming: DALI, Push.

Easy-to-install and replace bulb system.

Materials

Body: Polyurethane foam.
 Ceiling support: Steel.
 Diffuser: Methacrylate.

0625 03 White
 (RAL 9010)



Packaging

1 Box.
 0,27 x 0,96 x 0,96 m.
 Vol. 0,2488 m³.
 Gross weight 15,1 Kg.
 Net weight 13,59 Kg.

0627

New

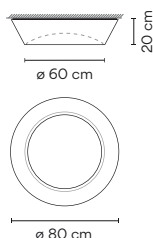

Light Source

4 x LED PLATE 20W 1050mA.
 / **2A:**
 LED 3000 K. CRI>90. 3049 lm. 112 lm/W.
 / **4A:**
 LED 4000 K. CRI>80. 10556 lm. 131 lm/W.
Driver Constant Current 1050mA.
 110-240V. 50/60Hz.
Dimming: DALI, 1-10V, Push.

Personalization options available

- Dimming: Casambi.
 Min. quantity, upcharge and extra lead time apply.

Materials

Body: Polyurethane foam.
 Ceiling support: Steel.
 Diffuser: Methacrylate.

0627 03/2A White
 (RAL 9016)

0627 03/4A White
 (RAL 9016)



Packaging

1 Box.
 0,49 x 1,365 x 1,365 m.
 Vol. 0,415 m³.
 Gross weight 16,9 Kg.
 Net weight 15,21 Kg.

Ceiling Outdoor

0630

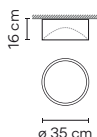

Light Source

1 x 2GX13 230V 55W (T5C).
Dimming: DALI, Push.

Surface.

Materials

Body: Polyurethane foam.
 Diffuser: Methacrylate.

0630 03 White
 (RAL 9010)



Packaging

1 Box.
 0,35 x 0,49 x 0,49 m.
 Vol. 0,0840 m³.
 Gross weight 3,8 Kg.
 Net weight 3,42 Kg.

0632

New

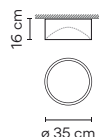

Light Source

1 x LED PLATE 20W 1050mA.
 / **2A:**
 LED 3000 K. CRI>90. 1019 lm. 112 lm/W.
 / **4A:**
 LED 4000 K. CRI>80. 2639 lm. 131 lm/W.
Driver Constant Current 1050mA.
 110-240V. 50/60Hz.
Dimming: DALI, 1-10V, Push.

Personalization options available

- Dimming: Casambi.
 Min. quantity, upcharge and extra lead time apply.

Materials

Body: Polyurethane foam.
 Ceiling support: Steel.
 Diffuser: Methacrylate.

0632 03/2A White
 (RAL 9016)

0632 03/4A White
 (RAL 9016)



Packaging

1 Box.
 0,49 x 1,365 x 1,365 m.
 Vol. 0,0840 m³.
 Gross weight 3,8 Kg.
 Net weight 3,42 Kg.

I.Cono

Design by Lievore, Altherr, Molina

Exuding a poised, Scandinavian presence, I.Cono is distinguished by its signature visor-shaped shade that's sleekly angled for a stylish look. Ideal for precision lighting or reading, its pure and clean design conceals its rotation mechanisms.



Table Floor

0700

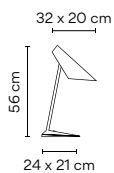

Light Source

1 x LED STAR CLASSIC P40 E14 230V 6W.
 Or
 1 x COMPACT FLUORESCENT E14 230V 15W.
 (MEGAMAN LILIPUT PLUS o similar) Max.
 Or
 1 x E14 230V 46W Eco Max.

Switch on the base.
Electric cable 2 m.

Materials

Shade: Polycarbonate.
Base: Zamak.
Vertical tube: Steel.

Packaging

1 Box.
0,27 x 0,60 x 0,60 m.
Vol. 0,0972 m³.
Gross weight 5,2 Kg.
Net weight 3,2 Kg.

0700 10 White
(NCS S 0300-N).

0700 21 Grey D1
(NCS S 7000-N).

0700 25 Beige D1
(NCS S 4005-Y50R).

0700 37 Terra Red
(NCS S 4040-Y70R).

0700 42 Blue M1
(NCS S 5010-B10G).

EAC IP20 CE

0712

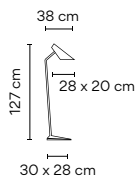

Light Source

1 x LED STAR CLASSIC P40 E14 230V 6W.
 Or
 1 x COMPACT FLUORESCENT E14 230V 15W.
 (MEGAMAN LILIPUT PLUS o similar) Max.
 Or
 1 x E14 230V 46W Eco Max.

Switch on the cable.
Electric cable 2 m.

Materials

Shade: Polycarbonate.
Base: Zamak.
Vertical tube: Steel.

Packaging

1 Box.
0,38 x 1,71 x 0,36m.
Vol. 0,2340 m³.
Gross weight 16 Kg.
Net weight 11,8 Kg.

0712 10 White
(NCS S 0300-N).

0712 21 Grey D1
(NCS S 7000-N).

0712 25 Beige D1
(NCS S 4005-Y50R).

0712 37 Terra Red
(NCS S 4040-Y70R).

0712 42 Blue M1
(NCS S 5010-B10G).

EAC IP20 CE

I.Cono

Wall

0720

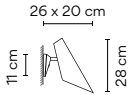

Light Source



1 x LED STAR CLASSIC P40 E14 230V 6W.
Or
1 x COMPACT FLUORESCENT E14 230V 15W.
(MEGAMAN LILIPUT PLUS o similar) Max.
Or
1 x E14 230V 46W Eco Max.

On/off switch on the wall plate.

Materials

Shade: Polycarbonate.
Wall plate: Zamak.

Packaging

1 Box.
0,25 x 0,42 x 0,42m.
Vol. 0,0441 m³.
Gross weight 2,2 Kg.
Net weight 1 Kg.

0720 10 White
(NCS S 0300-N).

0720 21 Grey D1
(NCS S 7000-N).

0720 25 Beige D1
(NCS S 4005-Y50R).

0720 37 Terra Red
(NCS S4040-Y70R).

0720 42 Blue M1
(NCS S 5010-B10G).



0725

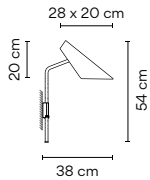

Light Source



1 x LED STAR CLASSIC P40 E14 230V 6W.
Or
1 x COMPACT FLUORESCENT E14 230V 15W.
(MEGAMAN LILIPUT PLUS o similar) Max.
Or
1 x E14 230V 46W Eco Max.

On/off switch on the cable.
Electric cable 1,5 m.

Materials

Shade: Polycarbonate.
Wall plate: Zamak.
Tube: Steel.

Packaging

1 Box.
0,26 x 0,51 x 0,51m.
Vol. 0,0676 m³.
Gross weight 2,5 Kg.
Net weight 1 Kg.

0725 10 White
(NCS S 0300-N).

0725 21 Grey D1
(NCS S 7000-N).

0725 25 Beige D1
(NCS S 4005-Y50R).

0725 37 Terra Red
(NCS S4040-Y70R).

0725 42 Blue M1
(NCS S 5010-B10G).



Flex

Design by Ramos & Bassols

Inspired by the smooth arc of the Bézier curve, Flex exemplifies the principle of “form follows function.” The LED table lamp features a sturdy steel base and an articulated, fully adjustable aluminum arm.



Table

0750

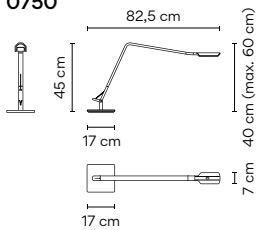

Light Source

 1 x LED PLATE 24V 8W.
LED 3000 K. CRI >80. 339,2 lm. 42,4 lm/W.
Driver Constant Voltage 24V.
100-240V. 50/60Hz.
Dimming: Optical Sensor.
Electric cable 2 m.

Materials

Head and Arm:
Aluminum.
Base: Steel.

Packaging

1 Box.
0,12 x 0,49 x 0,85 m.
Vol. 0,0479 m³.
Gross weight 5 Kg.
Net weight 3,6 Kg.

0750 03 Gloss white
(RAL 9016).

0750 18 Gloss graphite
(RAL 7016).



0751

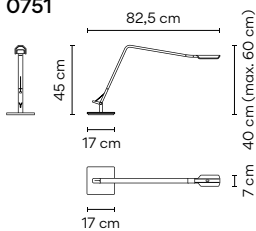

Light Source

 1 x LED PLATE 24V 8W.
LED 3000 K. CRI >80. 339,2 lm. 42,4 lm/W.
Driver Constant Voltage 24V.
100-240V. 50/60Hz.
Dimming: Optical Sensor.
Electric cable 2 m.

Materials

Head and Arm:
Aluminum.
Base: Steel.

Packaging

1 Box.
0,12 x 0,49 x 0,85 m.
Vol. 0,0479 m³.
Gross weight 5 Kg.
Net weight 3,6 Kg.

0751 03 White
(RAL 9006)

0751 18 Graphite
(RAL 7016)



0755

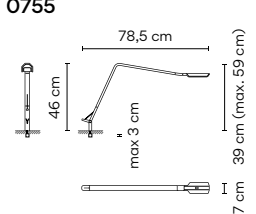

Light Source

 1 x LED PLATE 24V 8W.
LED 3000 K. CRI >80. 339,2 lm. 42,4 lm/W.
Driver Constant Voltage 24V.
100-240V. 50/60Hz.
Dimming: Optical Sensor.
Electric cable 2 m.

Materials

Head and Arm:
Aluminum.
Base: Steel.

Packaging

1 Box.
0,12 x 0,49 x 0,85 m.
Vol. 0,0479 m³.
Gross weight 3,7 Kg.
Net weight 2,3Kg.

0755 03 Gloss white
(RAL 9016).

0755 18 Gloss graphite
(RAL 7016).



0756

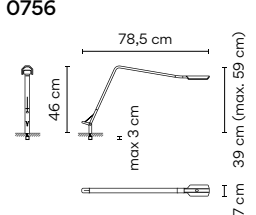

Light Source

 1 x LED PLATE 24V 8W.
LED 3000 K. CRI >80. 339,2 lm. 42,4 lm/W.
Driver Constant Voltage 24V.
100-240V. 50/60Hz.
Dimming: Optical Sensor.
Electric cable 2 m.

Materials

Head and Arm:
Aluminum.
Base: Steel.

Packaging

1 Box.
0,12 x 0,49 x 0,85 m.
Vol. 0,0479 m³.
Gross weight 3,7 Kg.
Net weight 2,3 Kg.

0756 03 White
(RAL 9006)

0756 18 Graphite
(RAL 7016)



Algorithm

Design by Toan Nguyen

Like a cloud of frozen rain, this collection brings together beauty and geometry. Mathematical order provides a magical harmony with an astonishing range of permutations and compositions. Can be customized to suit any space.

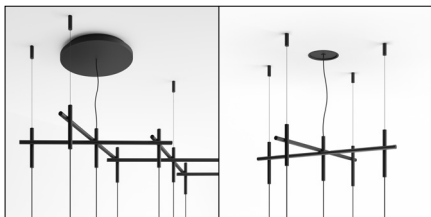
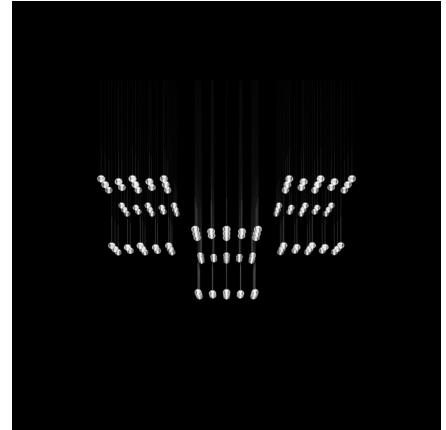
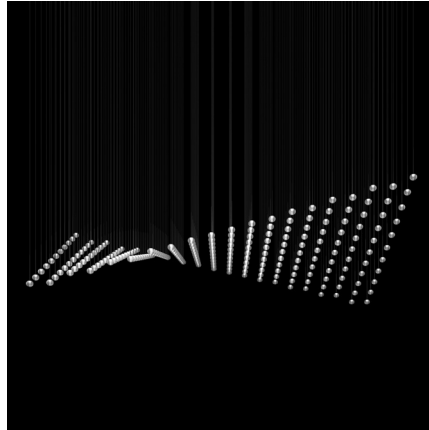

Surface canopy.

Request built-in canopy at vibia.com. 11,5 cm Die-cut diameter, 12 cm minimum height in ceiling.



Adjustable cable installation.

Rigid stem installation. Fixed at 25 cm.

Create your product configuration quickly and easily at vibia.com

Choose a type to work with:

A - Adjust height of standard model or change to built-in (recessed) canopy

To personalize luminaire height, without adjusting diffusers layout.

The steel cables that go from the structure to the ceiling are the only ones that allow the height of the lamp to be adjusted. The installation manual describes how to do this and how to cut the cables.

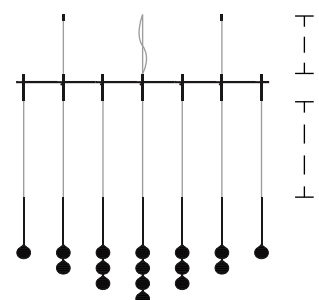

B - Create your product configuration

Create compositions to desired scale and customize light point layout to adapt it to the needs of your project.

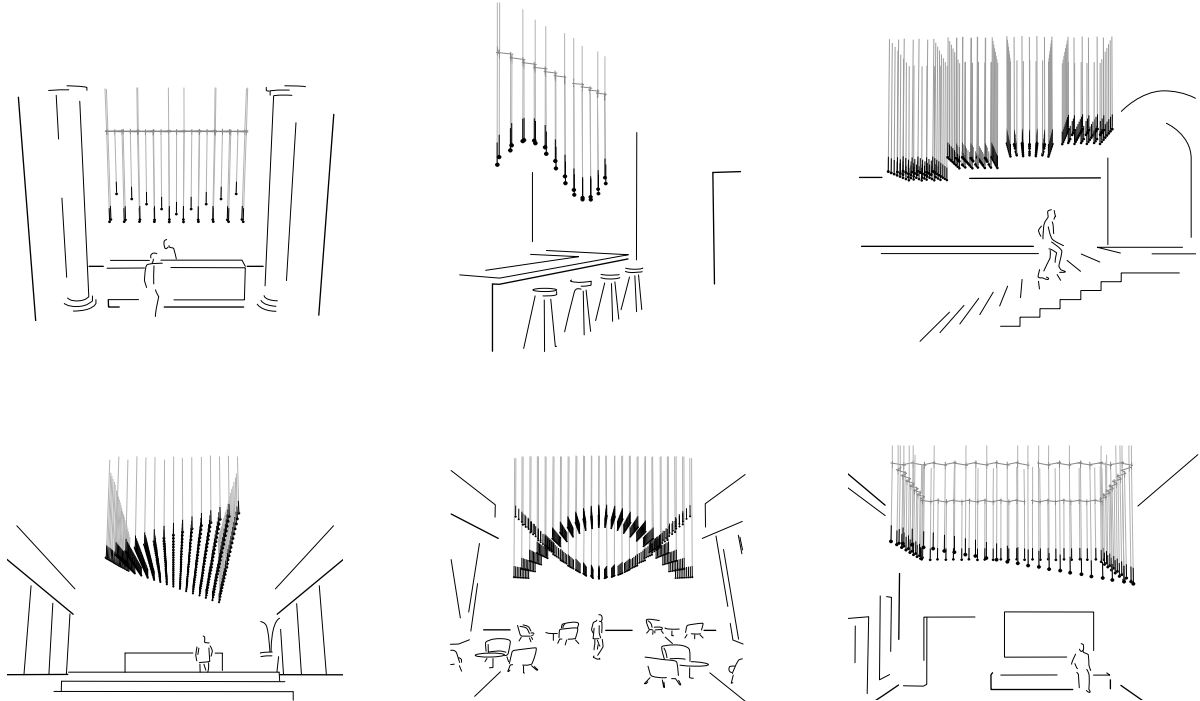

Pendants

0820

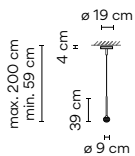

Light Source

 1 x LED 3,15W 1050mA.
LED 2700 K. CRI >80. 312 lm. 99 lm/W.
Driver Constant Current 1050mA.
100-240V. 50/60Hz.
Dimming: DALI, 1-10V, Push.

Surface.

Personalization options available

- Configuration layout at vibia.com
- LED 3000 K / 4000 K.
- Dimming: Casambi.
- Min. quantity, upcharge and extra lead time apply.

Materials

Ball: Blowed glass.
Glass fixation: Aluminum.
Ceiling rose: Steel.
Diffuser: PC.
Hanging structure: Steel.

Packaging

1 Box.
0,18 x 0,55 x 0,55 m.
Vol. 0,0131 m³.
Gross weight 2,17 Kg.
Net weight 1,57 Kg.

0820 18 /1A Graphite
(ADAPTA RF9913WX).

0820 93 /1A White
(RAL 9016).

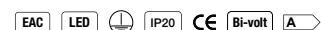

0822

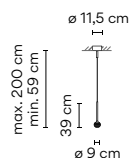

Light Source

 1 x LED 3,15W 1050mA.
LED 2700 K. CRI >80. 312 lm. 99 lm/W.
Driver Constant Current 1050mA.
100-240V. 50/60Hz.
Dimming: DALI, 1-10V, Push.

Built-in.

Personalization options available

- Configuration layout at vibia.com
- LED 3000 K / 4000 K.
- Dimming: Casambi.
- Min. quantity, upcharge and extra lead time apply.

Materials

Ball: Blowed glass.
Glass fixation: Aluminum.
Ceiling rose: Steel.
Diffuser: PC.
Hanging structure: Steel.

Packaging

1 Box.
0,18 x 0,55 x 0,55 m.
Vol. 0,0131 m³.
Gross weight 2,17 Kg.
Net weight 1,57 Kg.

0822 18 /1A Graphite
(ADAPTA RF9913WX).

0822 93 /1A White
(RAL 9016).

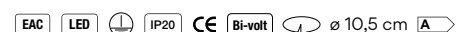

0825

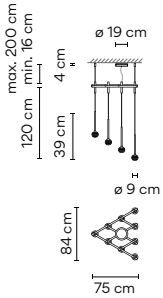

Light Source

10 x LED 3,15W 1050mA.
LED 2700 K. CRI >80. 3123 lm. 99 lm/W.
Driver Constant Current 1050mA.
 100-240V. 50/60Hz.
Dimming: DALI, 1-10V, Push.

Surface.

Personalization options available

- Configuration layout at vibia.com
 - LED 3000 K / 4000 K.
 - Dimming: Casambi.
- Min. quantity, upcharge and extra lead time apply.

Materials

Ball: Blowed glass.
 Glass fixation: Aluminum.
 Ceiling rose: Steel.
 Diffuser: PC.
 Hanging structure: Steel.

Packaging

2 Boxes.
 Total vol. 0,324 m³.
 Gross weight 15,5 Kg.
 Net weight 10,5 Kg.

0825 18 /1A Graphite
 (ADAPTA RF9913WX).

0825 93 /1A White
 (RAL 9016).



0827

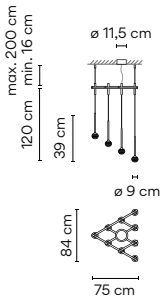

Light Source

10 x LED 3,15W 1050mA.
LED 2700 K. CRI >80. 3123 lm. 99 lm/W.
Driver Constant Current 1050mA.
 100-240V. 50/60Hz.
Dimming: DALI, 1-10V, Push.

Built-in.

Personalization options available

- Configuration layout at vibia.com
 - LED 3000 K / 4000 K.
 - Dimming: Casambi.
- Min. quantity, upcharge and extra lead time apply.

Materials

Ball: Blowed glass.
 Glass fixation: Aluminum.
 Ceiling rose: Steel.
 Diffuser: PC.
 Hanging structure: Steel.

Packaging

2 Boxes.
 Total vol. 0,324 m³.
 Gross weight 15,5 Kg.
 Net weight 10,5 Kg.

0827 18 /1A Graphite
 (ADAPTA RF9913WX).

0827 93 /1A White
 (RAL 9016).



0830

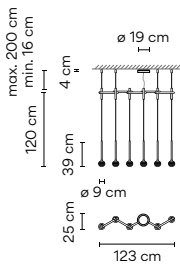

Light Source

6 x LED 3,15W 1050mA.
LED 2700 K. CRI >80. 1873 lm. 99 lm/W.
Driver Constant Current 1050mA.
 100-240V. 50/60Hz.
Dimming: DALI, 1-10V, Push.

Surface.

Personalization options available

- Configuration layout at vibia.com
 - LED 3000 K / 4000 K.
 - Dimming: Casambi.
- Min. quantity, upcharge and extra lead time apply.

Materials

Ball: Blowed glass.
 Glass fixation: Aluminum.
 Ceiling rose: Steel.
 Diffuser: PC.
 Hanging structure: Steel.

Packaging

2 Boxes.
 Total vol. 0,1705 m³.
 Gross weight 3,5 Kg.
 Net weight 5,8 Kg.

0830 18 /1A Graphite
 (ADAPTA RF9913WX).

0830 93 /1A White
 (RAL 9016).

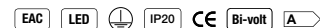

0832

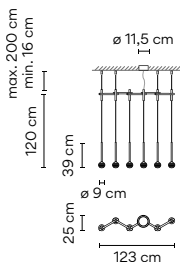

Light Source

6 x LED 3,15W 1050mA.
LED 2700 K. CRI >80. 1873 lm. 99 lm/W.
Driver Constant Current 1050mA.
 100-240V. 50/60Hz.
Dimming: DALI, 1-10V, Push.

Built-in.

Personalization options available

- Configuration layout at vibia.com
 - LED 3000 K / 4000 K.
 - Dimming: Casambi.
- Min. quantity, upcharge and extra lead time apply.

Materials

Ball: Blowed glass.
 Glass fixation: Aluminum.
 Ceiling rose: Steel.
 Diffuser: PC.
 Hanging structure: Steel.

Packaging

2 Boxes.
 Total vol. 0,1705 m³.
 Gross weight 3,5 Kg.
 Net weight 5,8 Kg.

0832 18 /1A Graphite
 (ADAPTA RF9913WX).

0832 93 /1A White
 (RAL 9016).



0835

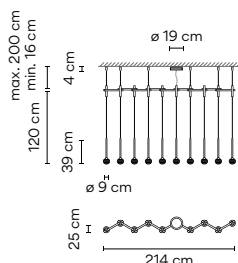

Light Source



10 x LED 3,15W 1050mA.
LED 2700 K. CRI >80. 3123 lm. 99 lm/W.
Driver Constant Current 1050mA.
 100-240V. 50/60Hz.
Dimming: DALI, 1-10V, Push.

Surface.

Personalization options available

- Configuration layout at vibia.com
- LED 3000 K / 4000 K.
- Dimming: Casambi.

Min. quantity, upcharge and extra lead time apply.

Materials

Ball: Blowed glass.
 Glass fixation:
 Aluminum.
 Ceiling rose: Steel.
 Diffuser: PC.
 Hanging structure:
 Steel.

Packaging

2 Boxes.
 Total vol. 0,3220 m³.
 Gross weight 15,5 Kg.
 Net weight 10,5 Kg.

0835 18 /1A Graphite
 (ADAPTA RF9913WX).

0835 93 /1A White
 (RAL 9016).

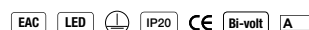

0837

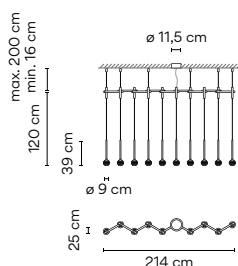

Light Source



10 x LED 3,15W 1050mA.
LED 2700 K. CRI >80. 3123 lm. 99 lm/W.
Driver Constant Current 1050mA.
 100-240V. 50/60Hz.
Dimming: DALI, 1-10V, Push.

Built-in.

Personalization options available

- Configuration layout at vibia.com
- LED 3000 K / 4000 K.
- Dimming: Casambi.

Min. quantity, upcharge and extra lead time apply.

Materials

Ball: Blowed glass.
 Glass fixation:
 Aluminum.
 Ceiling rose: Steel.
 Diffuser: PC.
 Hanging structure:
 Steel.

Packaging

2 Boxes.
 Total vol. 0,3220 m³.
 Gross weight 15,5 Kg.
 Net weight 10,5 Kg.

0837 18 /1A Graphite
 (ADAPTA RF9913WX).

0837 93 /1A White
 (RAL 9016).



0840

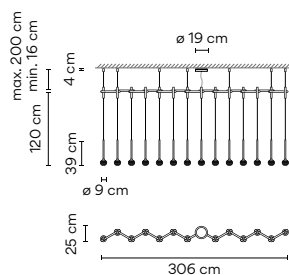

Light Source



14 x LED 3,15W 1050mA.
LED 2700 K. CRI >80. 4372 lm. 99 lm/W.
Driver Constant Current 1050mA.
 100-240V. 50/60Hz.
Dimming: DALI, 1-10V, Push.

Surface.

Personalization options available

- Configuration layout at vibia.com
- LED 3000 K / 4000 K.
- Dimming: Casambi.

Min. quantity, upcharge and extra lead time apply.

Materials

Ball: Blowed glass.
 Glass fixation:
 Aluminum.
 Ceiling rose: Steel.
 Diffuser: PC.
 Hanging structure:
 Steel.

Packaging

3 Boxes.
 Total vol. 0,5275 m³.
 Gross weight 17,3 Kg.
 Net weight 11,3 Kg.

0840 18 /1A Graphite
 (ADAPTA RF9913WX).

0840 93 /1A White
 (RAL 9016).



0842

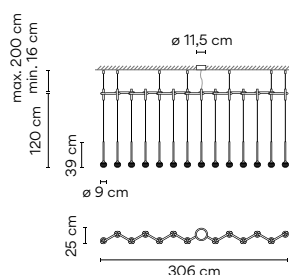

Light Source



14 x LED 3,15W 1050mA.
LED 2700 K. CRI >80. 4372 lm. 99 lm/W.
Driver Constant Current 1050mA.
 100-240V. 50/60Hz.
Dimming: DALI, 1-10V, Push.

Built-in.

Personalization options available

- Configuration layout at vibia.com
- LED 3000 K / 4000 K.
- Dimming: Casambi.

Min. quantity, upcharge and extra lead time apply.

Materials

Ball: Blowed glass.
 Glass fixation:
 Aluminum.
 Ceiling rose: Steel.
 Diffuser: PC.
 Hanging structure:
 Steel.

Packaging

3 Boxes.
 Total vol. 0,5275 m³.
 Gross weight 17,3 Kg.
 Net weight 11,3 Kg.

0842 18 /1A Graphite
 (ADAPTA RF9913WX).

0842 93 /1A White
 (RAL 9016).



0845

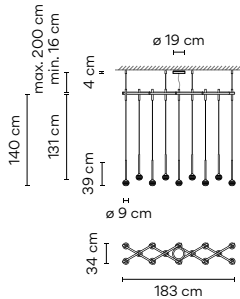

Light Source



14 x LED 3,15W 1050mA.
LED 2700 K. CRI >80.
 4372 lm. 99 lm/W.
Driver Constant Current 1050mA.
 100-240V. 50/60Hz.
Dimming: DALI, 1-10V, Push.

Surface.

Personalization options available
 - Configuration layout at vibia.com
 - LED 3000 K / 4000 K.
 - Dimming: Casambi.
 Min. quantity, upcharge and extra lead time apply.

Materials

Ball: Blowed glass.
 Glass fixation:
 Aluminum.
 Ceiling rose: Steel.
 Diffuser: PC.
 Hanging structure:
 Steel.

Packaging

2 Boxes.
 Total vol. 0,3220 m³.
 Gross weight 18,3 Kg.
 Net weight 13,3Kg.

0845 18 /1A Graphite
 (ADAPTA RF9913WX).

0845 93 /1A White
 (RAL 9016).



0847

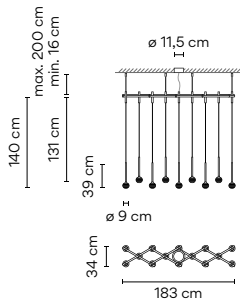

Light Source



14 x LED 3,15W 1050mA.
LED 2700 K. CRI >80.
 4372 lm. 99 lm/W.
Driver Constant Current 1050mA.
 100-240V. 50/60Hz.
Dimming: DALI, 1-10V, Push.

Built-in.

Personalization options available
 - Configuration layout at vibia.com
 - LED 3000 K / 4000 K.
 - Dimming: Casambi.
 Min. quantity, upcharge and extra lead time apply.

Materials

Ball: Blowed glass.
 Glass fixation:
 Aluminum.
 Ceiling rose: Steel.
 Diffuser: PC.
 Hanging structure:
 Steel.

Packaging

2 Boxes.
 Total vol. 0,3220 m³.
 Gross weight 18,3 Kg.
 Net weight 13,3Kg.

0847 18 /1A Graphite
 (ADAPTA RF9913WX).

0847 93 /1A White
 (RAL 9016).



0850

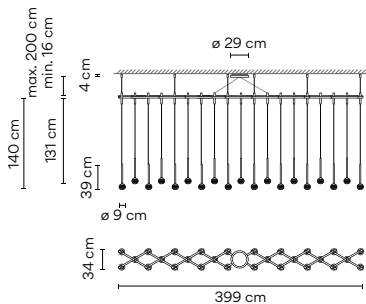

Light Source



29 x LED 3,15W 1050mA.
LED 2700 K. CRI >80.
 9056 lm. 99 lm/W.
Driver Constant Current 1050mA.
 100-240V. 50/60Hz.
Dimming: DALI, 1-10V, Push.

Surface.

Personalization options available
 - Configuration layout at vibia.com
 - LED 3000 K / 4000 K.
 - Dimming: Casambi.
 Min. quantity, upcharge and extra lead time apply.

Materials

Ball: Blowed glass.
 Glass fixation:
 Aluminum.
 Ceiling rose: Steel.
 Diffuser: PC.
 Hanging structure:
 Steel.

Packaging

2 Boxes.
 Total vol. 0,6260 m³.
 Gross weight 26 Kg.
 Net weight 20 Kg.

0850 18 /1A Graphite
 (ADAPTA RF9913WX).

0850 93 /1A White
 (RAL 9016).

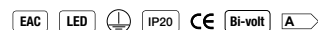

0852

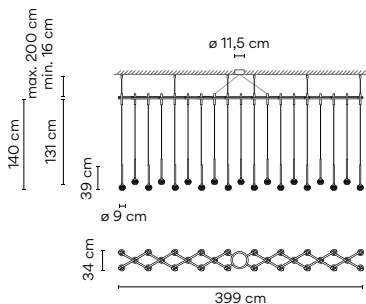

Light Source



29 x LED 3,15W 1050mA.
LED 2700 K. CRI >80.
 9056 lm. 99 lm/W.
Driver Constant Current 1050mA.
 100-240V. 50/60Hz.
Dimming: DALI, 1-10V, Push.

Built-in.

Personalization options available
 - Configuration layout at vibia.com
 - LED 3000 K / 4000 K.
 - Dimming: Casambi.
 Min. quantity, upcharge and extra lead time apply.

Materials

Ball: Blowed glass.
 Glass fixation:
 Aluminum.
 Ceiling rose: Steel.
 Diffuser: PC.
 Hanging structure:
 Steel.

Packaging

2 Boxes.
 Total vol. 0,6260 m³.
 Gross weight 26 Kg.
 Net weight 20 Kg.

0852 18 /1A Graphite
 (ADAPTA RF9913WX).

0852 93 /1A White
 (RAL 9016).

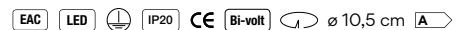

0855

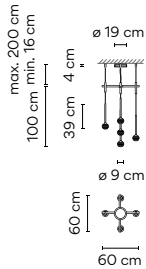

Light Source

5 x LED 3,15W 1050mA.
LED 2700 K. CRI >80. 1 562 lm. 99 lm/W.
Driver Constant Current 1050mA.
100-240V. 50/60Hz.
Dimming: DALI, 1-10V, Push.

Surface.

Personalization options available

- Configuration layout at vibia.com
- LED 3000 K / 4000 K.
- Dimming: Casambi.
Min. quantity, upcharge and extra lead time apply.

Materials

Ball: Blowed glass.
Glass fixation: Aluminum.
Ceiling rose: Steel.
Diffuser: PC.
Hanging structure: Steel.

Packaging

2 Boxes.
Total vol. 0,115 m³.
Gross weight 8,5 Kg.
Net weight 5.8 Kg.

0855 18 /1A Graphite
(ADAPTA RF9913WX).

0855 93 /1A White
(RAL 9016).



0857

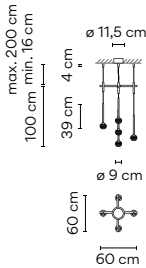

Light Source

5 x LED 3,15W 1050mA.
LED 2700 K. CRI >80. 1 562 lm. 99 lm/W.
Driver Constant Current 1050mA.
100-240V. 50/60Hz.
Dimming: DALI, 1-10V, Push.

Built-in.

Personalization options available

- Configuration layout at vibia.com
- LED 3000 K / 4000 K.
- Dimming: Casambi.
Min. quantity, upcharge and extra lead time apply.

Materials

Ball: Blowed glass.
Glass fixation: Aluminum.
Ceiling rose: Steel.
Diffuser: PC.
Hanging structure: Steel.

Packaging

2 Boxes.
Total vol. 0,115 m³.
Gross weight 8,5 Kg.
Net weight 5.8 Kg.

0857 18 /1A Graphite
(ADAPTA RF9913WX).

0857 93 /1A White
(RAL 9016).



0860

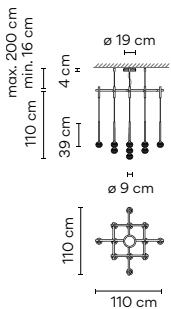

Light Source

13 x LED 3,15W 1050mA.
LED 2700 K. CRI >80. 4059 lm. 99 lm/W.
Driver Constant Current 1050mA.
100-240V. 50/60Hz.
Dimming: DALI, 1-10V, Push.

Surface.

Personalization options available

- Configuration layout at vibia.com
- LED 3000 K / 4000 K.
- Dimming: Casambi.
Min. quantity, upcharge and extra lead time apply.

Materials

Ball: Blowed glass.
Glass fixation: Aluminum.
Ceiling rose: Steel.
Diffuser: PC.
Hanging structure: Steel.

Packaging

2 Boxes.
Total vol. 0,3290 m³.
Gross weight 17,35 Kg.
Net weight 11,85 Kg.

0860 18 /1A Graphite
(ADAPTA RF9913WX).

0860 93 /1A White
(RAL 9016).



0862

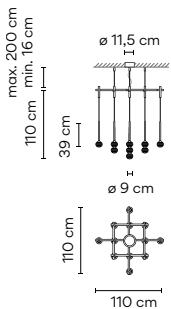

Light Source

13 x LED 3,15W 1050mA.
LED 2700 K. CRI >80. 4059 lm. 99 lm/W.
Driver Constant Current 1050mA.
100-240V. 50/60Hz.
Dimming: DALI, 1-10V, Push.

Built-in.

Personalization options available

- Configuration layout at vibia.com
- LED 3000 K / 4000 K.
- Dimming: Casambi.
Min. quantity, upcharge and extra lead time apply.

Materials

Ball: Blowed glass.
Glass fixation: Aluminum.
Ceiling rose: Steel.
Diffuser: PC.
Hanging structure: Steel.

Packaging

2 Boxes.
Total vol. 0,3290 m³.
Gross weight 17,35 Kg.
Net weight 11,85 Kg.

0862 18 /1A Graphite
(ADAPTA RF9913WX).

0862 93 /1A White
(RAL 9016).

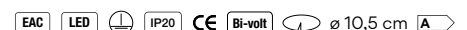

0865

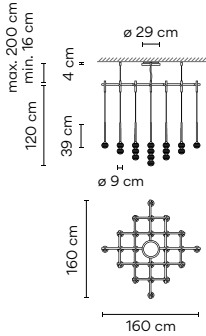

Light Source



25 x LED 3,15W 1050mA.
LED 2700 K. CRI >80. 4059 lm. 99 lm/W.
Driver Constant Current 1050mA.
 100-240V. 50/60Hz.
Dimming: DALI, 1-10V, Push.

Surface.

Personalization options available

- Configuration layout at vibia.com
 - LED 3000 K / 4000 K.
 - Dimming: Casambi.
- Min. quantity, upcharge and extra lead time apply.

Materials

Ball: Blowed glass.
 Glass fixation:
 Aluminum.
 Ceiling rose: Steel.
 Diffuser: PC.
 Hanging structure: Steel.

Packaging

2 Boxes.
 Total vol. 0,7280 m³.
 Gross weight 25,25 Kg.
 Net weight 20,25 Kg.

0865 18 /1A Graphite
 (ADAPTA RF9913WX).

0865 93 /1A White
 (RAL 9016).



0867

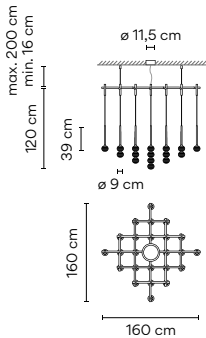

Light Source



25 x LED 3,15W 1050mA.
LED 2700 K. CRI >80. 4059 lm. 99 lm/W.
Driver Constant Current 1050mA.
 100-240V. 50/60Hz.
Dimming: DALI, 1-10V, Push.

Built-in.

Personalization options available

- Configuration layout at vibia.com
 - LED 3000 K / 4000 K.
 - Dimming: Casambi.
- Min. quantity, upcharge and extra lead time apply.

Materials

Ball: Blowed glass.
 Glass fixation:
 Aluminum.
 Ceiling rose: Steel.
 Diffuser: PC.
 Hanging structure: Steel.

Packaging

2 Boxes.
 Total vol. 0,7280 m³.
 Gross weight 25,25 Kg.
 Net weight 20,25 Kg.

0867 18 /1A Graphite
 (ADAPTA RF9913WX).

0867 93 /1A White
 (RAL 9016).



0870

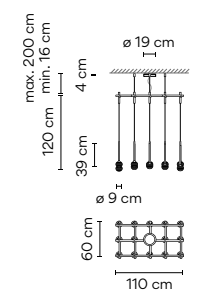

Light Source



15 x LED 3,15W 1050mA.
LED 2700 K. CRI >80. 4684 lm. 99 lm/W.
Driver Constant Current 1050mA.
 100-240V. 50/60Hz.
Dimming: DALI, 1-10V, Push.

Surface.

Personalization options available

- Configuration layout at vibia.com
 - LED 3000 K / 4000 K.
 - Dimming: Casambi.
- Min. quantity, upcharge and extra lead time apply.

Materials

Ball: Blowed glass.
 Glass fixation: Aluminum.
 Ceiling rose: Steel.
 Diffuser: PC.
 Hanging structure: Steel.

Packaging

2 Boxes.
 Total vol. 0,2679 m³.
 Gross weight 18,25 Kg.
 Net weight 13,75 Kg.

0870 18 /1A Graphite
 (ADAPTA RF9913WX).

0870 93 /1A White
 (RAL 9016).

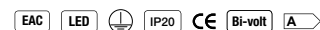

0872

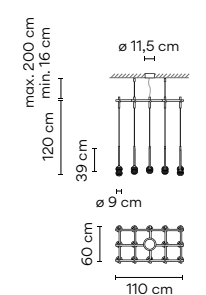

Light Source



15 x LED 3,15W 1050mA.
LED 2700 K. CRI >80. 4684 lm. 99 lm/W.
Driver Constant Current 1050mA.
 100-240V. 50/60Hz.
Dimming: DALI, 1-10V, Push.

Built-in.

Personalization options available

- Configuration layout at vibia.com
 - LED 3000 K / 4000 K.
 - Dimming: Casambi.
- Min. quantity, upcharge and extra lead time apply.

Materials

Ball: Blowed glass.
 Glass fixation: Aluminum.
 Ceiling rose: Steel.
 Diffuser: PC.
 Hanging structure: Steel.

Packaging

2 Boxes.
 Total vol. 0,2679 m³.
 Gross weight 18,25 Kg.
 Net weight 13,75 Kg.

0872 18 /1A Graphite
 (ADAPTA RF9913WX).

0872 93 /1A White
 (RAL 9016).

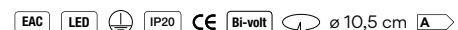

0875

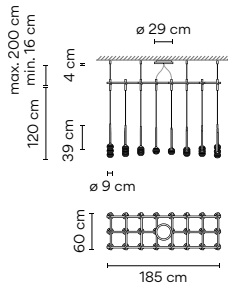

Light Source

24 x LED 3,15W 1050mA.
LED 2700 K. CRI >80. 7495 lm. 99 lm/W.
Driver Constant Current 1050mA.
100-240V. 50/60Hz.
Dimming: DALI, 1-10V, Push.

Surface.

Personalization options available

- Configuration layout at vibia.com
- LED 3000 K / 4000 K.
- Dimming: Casambi.
Min. quantity, upcharge and extra lead time apply.

Materials

Ball: Blowed glass.
Glass fixation: Aluminum.
Ceiling rose: Steel.
Diffuser: PC.
Hanging structure: Steel.

Packaging

2 Boxes.
Total vol. 0,4500 m³.
Gross weight 25,8 Kg.
Net weight 19,8Kg.

0875 18 /1A Graphite
(ADAPTA RF9913WX).

0875 93 /1A White
(RAL 9016).



0877

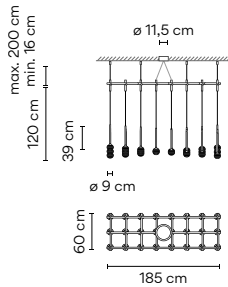

Light Source

24 x LED 3,15W 1050mA.
LED 2700 K. CRI >80. 7495 lm. 99 lm/W.
Driver Constant Current 1050mA.
100-240V. 50/60Hz.
Dimming: DALI, 1-10V, Push.

Built-in.

Personalization options available

- Configuration layout at vibia.com
- LED 3000 K / 4000 K.
- Dimming: Casambi.
Min. quantity, upcharge and extra lead time apply.

Materials

Ball: Blowed glass.
Glass fixation: Aluminum.
Ceiling rose: Steel.
Diffuser: PC.
Hanging structure: Steel.

Packaging

2 Boxes.
Total vol. 0,4500 m³.
Gross weight 25,8 Kg.
Net weight 19,8Kg.

0877 18 /1A Graphite
(ADAPTA RF9913WX).

0877 93 /1A White
(RAL 9016).

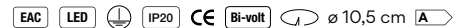

0880

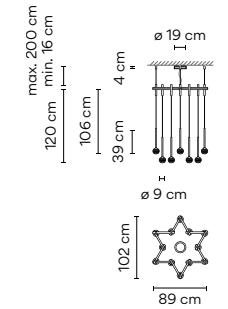

Light Source

12 x LED 3,15W 1050mA.
LED 2700 K. CRI >80. 3747 lm. 99 lm/W.
Driver Constant Current 1050mA.
100-240V. 50/60Hz.
Dimming: DALI, 1-10V, Push.

Surface.

Personalization options available

- Configuration layout at vibia.com
- LED 3000 K / 4000 K.
- Dimming: Casambi.
Min. quantity, upcharge and extra lead time apply.

Materials

Ball: Blowed glass.
Glass fixation: Aluminum.
Ceiling rose: Steel.
Diffuser: PC.
Hanging structure: Steel.

Packaging

2 Boxes.
Total vol. 0,3290 m³.
Gross weight 16,5 Kg.
Net weight 11,4 Kg.

0880 18 /1A Graphite
(ADAPTA RF9913WX).

0880 93 /1A White
(RAL 9016).

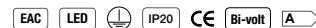

0882

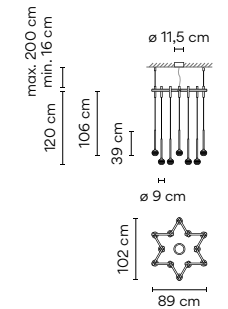

Light Source

12 x LED 3,15W 1050mA.
LED 2700 K. CRI >80. 3747 lm. 99 lm/W.
Driver Constant Current 1050mA.
100-240V. 50/60Hz.
Dimming: DALI, 1-10V, Push.

Built-in.

Personalization options available

- Configuration layout at vibia.com
- LED 3000 K / 4000 K.
- Dimming: Casambi.
Min. quantity, upcharge and extra lead time apply.

Materials

Ball: Blowed glass.
Glass fixation: Aluminum.
Ceiling rose: Steel.
Diffuser: PC.
Hanging structure: Steel.

Packaging

2 Boxes.
Total vol. 0,3290 m³.
Gross weight 16,5 Kg.
Net weight 11,4 Kg.

0882 18 /1A Graphite
(ADAPTA RF9913WX).

0882 93 /1A White
(RAL 9016).

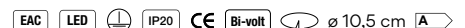

Algorithm

0885

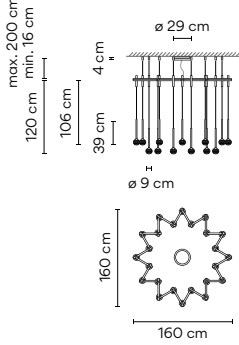

Light Source

24 x LED 3,15W 1050mA.
LED 2700 K. CRI >80. 7495 lm. 99 lm/W.
Driver Constant Current 1050mA.
 100-240V. 50/60Hz.
Dimming: DALI, 1-10V, Push.

Surface.

Personalization options available

- Configuration layout at vibia.com
 - LED 3000 K / 4000 K.
 - Dimming: Casambi.
- Min. quantity, upcharge and extra lead time apply.

Materials

Ball: Blowed glass.
 Glass fixation: Aluminum.
 Ceiling rose: Steel.
 Diffuser: PC.
 Hanging structure: Steel.

Packaging

2 Boxes.
 Total vol. 0,7280 m³.
 Gross weight 25,25 Kg.
 Net weight 20,25 Kg.

0885 18 /1A Graphite
 (ADAPTA RF9913WX).

0885 93 /1A White
 (RAL 9016).



0887

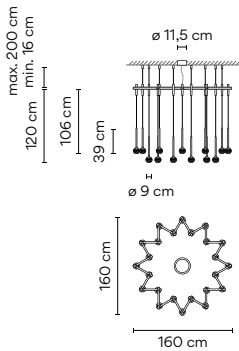

Light Source

24 x LED 3,15W 1050mA.
LED 2700 K. CRI >80. 7495 lm. 99 lm/W.
Driver Constant Current 1050mA.
 100-240V. 50/60Hz.
Dimming: DALI, 1-10V, Push.

Built-in.

Personalization options available

- Configuration layout at vibia.com
 - LED 3000 K / 4000 K.
 - Dimming: Casambi.
- Min. quantity, upcharge and extra lead time apply.

Materials

Ball: Blowed glass.
 Glass fixation: Aluminum.
 Ceiling rose: Steel.
 Diffuser: PC.
 Hanging structure: Steel.

Packaging

2 Boxes.
 Total vol. 0,7280 m³.
 Gross weight 25,25 Kg.
 Net weight 20,25 Kg.

0887 18 /1A Graphite
 (ADAPTA RF9913WX).

0887 93 /1A White
 (RAL 9016).

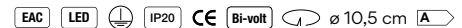

Slim

Design by Jordi Vilardell

Elegant and magical, like drops of light falling from the sky, Slim's long, slender strands are suspended by fibre cords to draw the eye upwards.



Pendants

0914

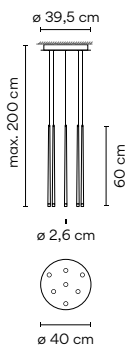

Light Source

7 x LED 2,1W 700mA.
LED 2700 K. CRI >80. 1395 lm. 95 lm/W.
Driver Constant Current 700mA.
110-240V. 50/60Hz.
Dimming: 1-10V, Push.

Surface.

Personalization options available

- LED 3000 K / 4000 K.
- Dimming: DALI or Casambi.
- Extra cable length.

Min. quantity, upcharge and extra lead time apply.

Materials

Diffuser: Glass.
Body: Fiberglass / Carbon fiber.
Canopy Plate: Steel.

Packaging

1 Box.
0,27 x 0,76 x 0,76 m.
Vol. 0,1560 m³.
Gross weight 10,2 Kg.
Net weight 6,8 Kg.

0914 03 /1B White fiber
(RAL 9016).

0914 04 /1B Black carbon fiber
(Natural finish).



0915

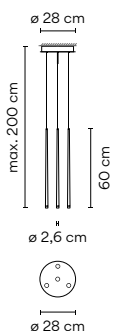

Light Source

4 x LED 2,1W 700mA.
LED 2700 K. CRI >80. 797,2 lm. 95 lm/W.
Driver Constant Current 700mA.
110-240V. 50/60Hz.
Dimming: 1-10V, Push.

Surface.

Personalization options available

- LED 3000 K / 4000 K.
- Dimming: DALI or Casambi.
- Extra cable length.

Min. quantity, upcharge and extra lead time apply.

Materials

Diffuser: Glass.
Body: Fiberglass / Carbon fiber.
Canopy Plate: Steel.

Packaging

1 Box.
0,27 x 0,76 x 0,76 m.
Vol. 0,1560 m³.
Gross weight 6,4 Kg.
Net weight 3,6 Kg.

0915 03 /1B White fiber
(RAL 9016).

0915 04 /1B Black carbon fiber
(Natural finish).

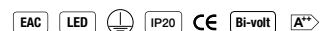

Slim

0916

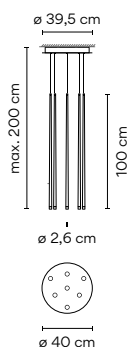

Light Source



 7 x LED 2,1W 700mA.
LED 2700 K. CRI >80. 1268,5 lm. 95 lm/W.
Driver Constant Current 700mA.
 110-240V. 50/60Hz.
Dimming: 1-10V, Push.

Surface.

Personalization options available

- LED 3000 K / 4000 K.
- Dimming: DALI or Casambi.
- Extra cable length.

Min. quantity, upcharge and extra lead time apply.

Materials

Diffuser: Glass.
 Body: Fiberglass / Carbon fiber.
 Canopy Plate: Steel.

Packaging

1 Box.
 0,22 x 0,48 x 1,20 m.
 Vol. 0,1278 m³.
 Gross weight 13 Kg.
 Net weight 9,6 Kg.

0916 03 /1B White fiber
 (RAL 9016).

0916 04 /1B Black carbon fiber
 (Natural finish).

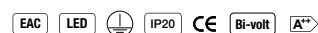

0917

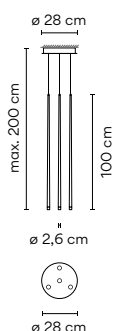

Light Source



 4 x LED 2,1W 700mA.
LED 2700 K. CRI >80. 797,2 lm. 95 lm/W.
Driver Constant Current 700mA.
 110-240V. 50/60Hz.
Dimming: 1-10V, Push.

Surface.

Personalization options available

- LED 3000 K / 4000 K.
- Dimming: DALI or Casambi.
- Extra cable length.

Min. quantity, upcharge and extra lead time apply.

Materials

Diffuser: Glass.
 Body: Fiberglass / Carbon fiber.
 Canopy Plate: Steel.

Packaging

1 Box.
 0,22 x 0,48 x 1,20 m.
 Vol. 0,1278m³.
 Gross weight 8 Kg.
 Net weight 5,2 Kg.

0917 03 /1B White fiber
 (RAL 9016).

0917 04 /1B Black carbon fiber
 (Natural finish).



0920

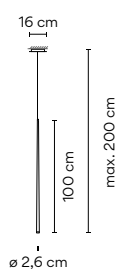

Light Source



 1 x LED 2,1W 700mA.
LED 2700 K. CRI >80. 199,3 lm. 95 lm/W.
Driver Constant Current 700mA.
 100-240V. 50/60Hz.
 / **10:** Dimming: No. (100-240V).
 / **1B:** Dimming: 1-10V, Push. (110-240V).

Surface.

Personalization options available

- LED 3000 K./ 4000 K.
- Dimming: DALI or Casambi.
- Extra cable length.

Min. quantity, upcharge and extra lead time apply.

Materials

Diffuser: Glass.
 Body: Fiberglass / Carbon fiber.
 Canopy Plate: Steel.

Packaging

1 Box.
 0,07 x 0,19 x 1,20 m.
 Vol. 0,0155 m³.
 Gross weight 2,14 Kg.
 Net weight 1,2 Kg.

0920 03 /10 White fiber
 (RAL 9016).

0920 03 /1B White fiber
 (RAL 9016).

0920 04 /10 Black carbon fiber
 (Natural finish).

0920 04 /1B Black carbon fiber
 (Natural finish).

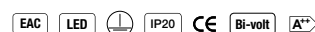

Slim

0925

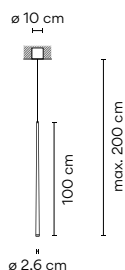

Light Source



1 x LED 2,1W 700mA.
LED 2700 K. CRI >80. 199,3 lm. 95 lm/W.
Driver Constant Current 700mA.
100-240V. 50/60Hz.
/ **10**: Dimming: No. (100-240V).
/ **1B**: Dimming: 1-10V, Push. (110-240V).

Built-in.

Personalization options available

- LED 3000 K / 4000 K.
- Dimming: DALI or Casambi.
- Extra cable length.

Min. quantity, upcharge and extra lead time apply.

Materials

Diffuser: Glass.
Body: Fiberglass / Carbon fiber.
Canopy Plate: Steel.

Packaging

1 Box.
0,17 x 0,19 x 1,21 m.
Vol. 0,0370 m³.
Gross weight 2,48 Kg.
Net weight 1,35 Kg.

0925 03 /10 White fiber
(RAL 9016).

0925 03 /1B White fiber
(RAL 9016).

0925 04 /10 Black carbon fiber
(Natural finish).

0925 04 /1B Black carbon fiber
(Natural finish).



0931

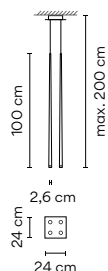

Light Source



4 x LED 2,1W 700mA.
LED 2700 K. CRI >80. 797,2 lm. 95 lm/W.
Driver Constant Current 700mA.
100-240V. 50/60Hz.
Dimming: 1-10V, Push.

Surface.

Personalization options available

- LED 3000 K / 4000 K.
- Dimming: DALI or Casambi.
- Extra cable length.

Min. quantity, upcharge and extra lead time apply.

Materials

Diffuser: Glass.
Body: Fiberglass / Carbon fiber.
Canopy Plate: Steel.

Packaging

1 Box.
0,22 x 0,48 x 1,20 m.
Vol. 0,1267 m³.
Gross weight 8 Kg.
Net weight 5,2 Kg.

0931 03 /1B White fiber
(RAL 9016).

0931 04 /1B Black carbon fiber
(Natural finish).



0933

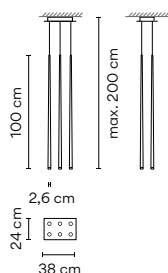

Light Source



6 x LED 2,1W 700mA.
LED 2700 K. CRI >80. 1195,7 lm. 95 lm/W.
Driver Constant Current 700mA.
110-240V. 50/60Hz.
Dimming: 1-10V, Push.

Surface.

Personalization options available

- LED 3000 K / 4000 K.
- Dimming: DALI or Casambi.
- Extra cable length.

Min. quantity, upcharge and extra lead time apply.

Materials

Diffuser: Glass.
Body: Fiberglass / Carbon fiber.
Canopy Plate: Steel.

Packaging

1 Box.
0,22 x 0,48 x 1,20 m.
Vol. 0,1267 m³.
Gross weight 12,5 Kg.
Net weight 9,1 Kg.

0933 03 /1B White fiber
(RAL 9016).

0933 04 /1B Black carbon fiber
(Natural finish).



Slim

0935

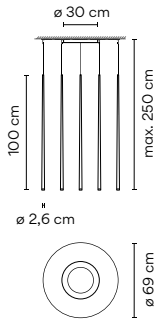

Light Source

 10 x LED 1W 350mA.
LED 2700 K. CRI >80. 1217,2 lm. 122 lm/W.
Driver Constant Current 350mA.
 110-240V. 50/60Hz.
Dimming: 1-10V, Push.

Surface.

Personalization options available

- LED 3000 K / 4000 K.
- Dimming: DALI or Casambi.
- Extra cable length.

Min. quantity, upcharge and extra lead time apply.

Materials

Diffuser: Glass.
 Body: Fiberglass / Carbon fiber.
 Canopy Plate: Steel.

Packaging

1 Box.
 1,14 x 1,14 x 0,34 m.
 Vol. 0,4410 m³.
 Gross weight 19,2 Kg.
 Net weight 14,2 Kg.

0935 03 /1B White fiber
 (RAL 9016).

0935 04 /1B Black carbon fiber
 (Natural finish).



0937

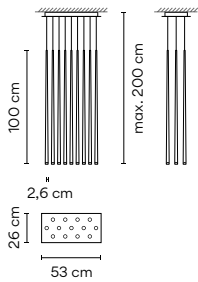

Light Source

 13 x LED 2,1W 700mA.
LED 2700 K. CRI >80. 2590,8 lm. 95 lm/W.
Driver Constant Current 700mA.
 110-240V. 50/60Hz.
Dimming: DALI, 1-10V, Push.

Surface.

Personalization options available

- LED 3000 K / 4000 K.
- Dimming: DALI or Casambi.
- Extra cable length.

Min. quantity, upcharge and extra lead time apply.

Materials

Diffuser: Glass.
 Body: Fiberglass / Carbon fiber.
 Canopy Plate: Steel.

Packaging

1 Box.
 0,22 x 0,48 x 1,20 m.
 Vol. 0,1267 m³.
 Gross weight 12,5 Kg.
 Net weight 18,46 Kg.

0937 03 /1A White fiber
 (RAL 9016).

0937 04 /1A Black carbon fiber
 (Natural finish).



0940

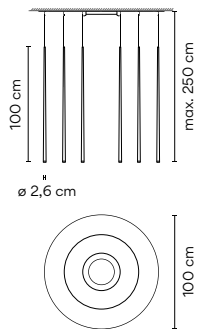

Light Source

 22 x LED 1W 350mA.
LED 2700 K. CRI >80. 2677,8 lm. 122 lm/W.
Driver Constant Current 350mA.
 110-240V. 50/60Hz.
Dimming: 1-10V, Push.

Surface.

Personalization options available

- LED 3000 K / 4000 K.
- Dimming: DALI or Casambi.
- Extra cable length.

Min. quantity, upcharge and extra lead time apply.

Materials

Diffuser: Glass.
 Body: Fiberglass / Carbon fiber.
 Canopy Plate: Steel.

Packaging

1 Box.
 1,14 x 1,14 x 0,34 m.
 Vol. 0,4420 m³.
 Gross weight 29,9 Kg.
 Net weight 21,9 Kg.

0940 03 /1B White fiber
 (RAL 9016).

0940 04 /1B Black carbon fiber
 (Natural finish).



Scotch

Design by Oscar & Sergi Devesa

Evoking a sleek ice sculpture, Scotch is at once strong and subtle. Crafted of a thick, pressed-glass diffuser with a frosted-glass interior, its spherical design provides an understated accent and a warm glow.



Ceiling Wall Outdoor

0960

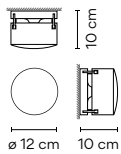

Light Source

 1 x G9 230V 33W Eco Max.

Materials

Diffuser: Glass.
Body: Zamak.

0960 01 Chrome
(Metallic finish).



Packaging

1 Box.
0,26 x 0,26 x 0,26 m.
Vol. 0,0175 m³.
Gross weight 2,5 Kg.
Net weight 1,7 Kg.

0962

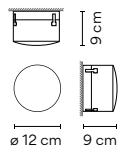

Light Source

 1 x LED 3W 350mA.
LED 2700 K, CRI >80. 352,1 lm. 117,3 lm/W.
Driver Constant Current 350mA.
100-240V. 50/60Hz.

Materials

Diffuser: Glass.
Body: Zamak.

0962 01/10 Chrome
(Metallic finish).



Packaging

1 Box.
0,26 x 0,26 x 0,26 m.
Vol. 0,0175 m³.
Gross weight 2,5 Kg.
Net weight 1,7 Kg.

Personalization options available

- LED 3000 K / 4000 K.
Min. quantity, upcharge and extra lead time apply.

Quadra Ice

Classic and timeless silhouette.
Minimal presence. Integrates readily.

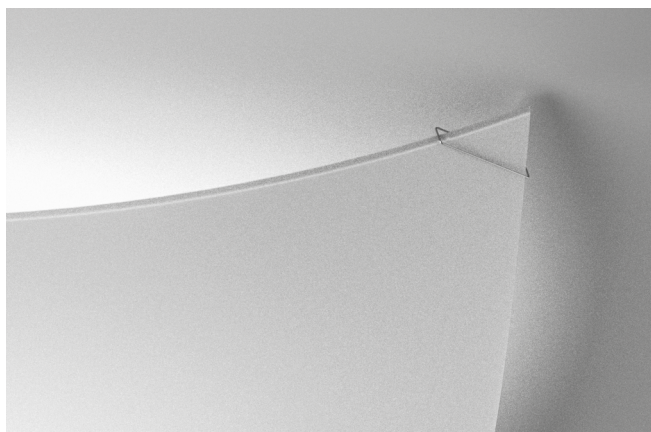

Ceiling

1128

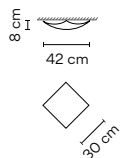

Light Source



1 x R7s 80mm 230V 120W Eco Max.

Materials

Ceiling support: Steel.
Diffuser: Glass.

Packaging

1 Box.
0,21 x 0,41 x 0,41 m.
Vol. 0,0353 m³.
Gross weight 2,24 Kg.
Net weight 1,44 Kg.

1128 00 White glass
(RAL 9016)



1129

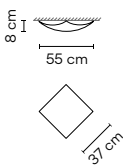

Light Source



1 x R7s 117mm 230V 230W Eco Max.

Materials

Ceiling support: Steel.
Diffuser: Glass.









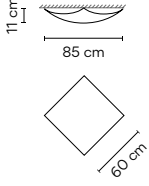

Packaging

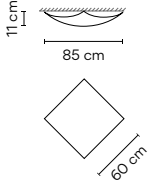
1 Box.
0,22 x 0,46 x 0,46 m.
Vol. 0,0465 m³.
Gross weight 3 Kg.
Net weight 2,95 Kg.

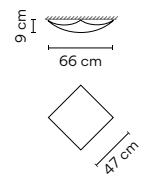
1129 00 White glass
(RAL 9016)

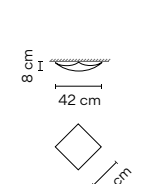

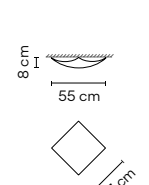
Quadra Ice

<p>1132</p> 	<p>Light Source</p>  <p>1 x 2GX13 230V 22W (T5C) 1 x 2GX13 230V 40W (T5C)</p>	<p>Materials Ceiling support: Steel. Diffuser: Glass.</p> <p>Packaging 1 Box. 0,27 x 0,76 x 0,76 m. Vol. 0,1560 m³. Gross weight 8,4 Kg. Net weight 5,5 Kg.</p>	<p>1132 00 White glass (RAL 9016)</p> 
<p>1133</p> 	<p>Light Source</p>  <p>1 x R7s 117mm 230V 230W Eco Max.</p>	<p>Materials Ceiling support: Steel. Diffuser: Glass.</p> <p>Packaging 1 Box. 0,27 x 0,76 x 0,76 m. Vol. 0,1560 m³. Gross weight 7,6 Kg. Net weight 4,5 Kg.</p>	<p>1133 00 White glass (RAL 9016)</p> 
<p>1134</p> 	<p>Light Source</p>  <p>1 x R7s 117mm 230V 230W Eco Max.</p>	<p>Materials Ceiling support: Steel. Diffuser: Glass.</p> <p>Packaging 1 Box. 0,27 x 0,60 x 0,60 m. Vol. 0,0972 m³. Gross weight 6,2 Kg. Net weight 4,2 Kg.</p>	<p>1134 00 White glass (RAL 9016)</p> 
<p>1138</p> 	<p>Light Source</p>  <p>1 x LED PLATE 16,5W 500mA Led 2700 K. CRI >80. 1637 lm. 99,2 lm/W. Driver Constant Current 500mA. 110-240V. 50/60Hz. Dimming: 1-10V, Push.</p> <p>Personalization options available - LED 3000 K / 4000 K. - Dimming: DALI or Casambi. Min. quantity, upcharge and extra lead time apply.</p>	<p>Materials Ceiling support: Steel. Diffuser: Glass.</p> <p>Packaging 1 Box. 0,21 x 0,41 x 0,41 m. Vol. 0,0353 m³. Gross weight 2,24 Kg. Net weight 1,65 Kg.</p>	<p>1138 00 /1B White glass (RAL 9016)</p> 
<p>1139</p> 	<p>Light Source</p>  <p>1 x LED PLATE 23,1W 700mA Led 2700 K. CRI >80. 2203 lm. 95 lm/W. Driver Constant Current 700mA. 110-240V. 50/60Hz. Dimming: 1-10V, Push.</p> <p>Personalization options available - LED 3000 K / 4000 K. - Dimming: DALI or Casambi. Min. quantity, upcharge and extra lead time apply.</p>	<p>Materials Ceiling support: Steel. Diffuser: Glass.</p> <p>Packaging 1 Box. 0,22 x 0,46 x 0,46 m. Vol. 0,0465 m³. Gross weight 3 Kg. Net weight 2,3 Kg.</p>	<p>1139 00 /1B White glass (RAL 9016)</p> 

Jazz

Design by Diego Fortunato

Sculptural design with a marked sensual but strong character.
Ancestral forms converted into modern design icons.



Floor

1330

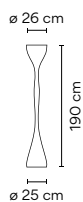

Light Source



1 x R7s 117mm 230V 400W Eco.

Dimmer on the cable.
Electric cable 2,5 m.

Personalization options available

-Finish customization
(Available options: Vibia color palette).
Min. quantity, upcharge and extra lead time apply.

Materials

Body: Polyurethane.
Diffuser: Glass.

Packaging

2 Boxes
Total Vol. 0,1880 m³.
Gross weight 19,8 Kg.
Net weight 15 Kg.

1330 10 White

(NCS S 0300-N).

1330 25 Beige D1

(NCS S 4005-Y50R).

1330 45 Blue D1

(NCS S 7010-B10G).



Table

1332

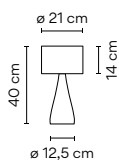

Light Source



3 x LED G9 230V 3W 2800K MEGAMAN.

Or
3 x COMPACT FLUORESCENT
G9 230V 7W Max.

Or
3 x G9 230V 40W Max.

Switch on the cable.
Electric cable 2,5 m.

Personalization options available

-Finish customization
(Available options: Vibia color palette).
Min. quantity, upcharge and extra lead time apply.

Materials

Body: Polyurethane.
Diffuser: Optical-glass.
Shade: Aluminum.

Packaging

1 Box.
0,26 x 0,51 x 0,51 m.
Vol. 0,0676 m³.
Gross weight 3,074 Kg.
Net weight 1,9 Kg.

1332 10 White

(NCS S 0300-N).

1332 25 Beige D1

(NCS S 4005-Y50R).

1332 45 Blue D1



(NCS S 7010-B10G).

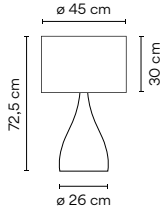

1333



Light Source

-  Or  Or 
- 4 x Core Pro LEDbulb E27 230V 10W.
- Or
- 4 x COMPACT FLUORESCENT E27 230V 11W Max.
- Or
- 4 x E27 230V 46W Eco Max.

Switch on the cable.
Electric cable 1,5 m.

Personalization options available
-Finish customization
(Available options: Vibia color palette).
Min. quantity, upcharge and extra lead time apply.

Materials

Body: Polyurethane.
Diffuser: Optical-glass.
Shade: Aluminum.

Packaging

1 Box.
0,51 x 0,51 x 1,14 m.
Vol. 0,2960 m³.
Gross weight 10 Kg.
Net weight 7,9 Kg.

1333 10 White
(NCS S 0300-N).

1333 25 Beige D1
(NCS S 4005-Y50R).

1333 45 Blue D1
(NCS S 7010-B10G).



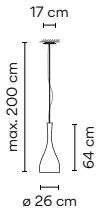

Pendants

1336



Light Source

-  Or  Or 
- 1 x LEDSpot PAR30S E27 230V 9,5W.
- Or
- 1 x COMPACT FLUORESCENT E27 230V 30W Max.
- Or
- 1 x PAR 30 E27 230V 75W Max.

Personalization options available
-Finish customization
(Available options: Vibia color palette).
- Extra cable length.
Min. quantity, upcharge and extra lead time apply.

Materials

Body: Polyurethane.
Diffuser: Glass.
Canopy: Steel.
Reflector: Aluminum.

Packaging

1 Box.
0,39 x 0,37 x 1,11 m.
Vol. 0,1601 m³.
Gross weight 6 Kg.
Net weight 4,5 Kg.

1336 10 White
(NCS S 0300-N).

1336 25 Beige D1
(NCS S 4005-Y50R).



1336 45 Blue D1
(NCS S 7010-B10G).

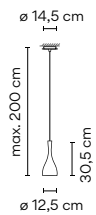

1338



Light Source

-  Or 
- 1 x LEDSpot PAR30S E27 230V 9,5W.
- Or
- 1 x PAR 30 E27 230V 75W Max.

Personalization options available
-Finish customization
(Available options: Vibia color palette).
- Extra cable length.
Min. quantity, upcharge and extra lead time apply.

Materials

Body: Polyurethane.
Reflector: Aluminum.
Canopy: Steel.

Packaging

1 Box.
0,21 x 0,21 x 0,48 m.
Vol. 0,0212 m³.
Gross weight 1,702 Kg.
Net weight 0,9 Kg.

1338 10 White
(NCS S 0300-N).

1338 25 Beige D1
(NCS S 4005-Y50R).

1338 45 Blue D1
(NCS S 7010-B10G).



Flamingo

Design by Antoni Arola

Displaying the elegant poise of the bird that inspired it, Flamingo projects a feeling of weightlessness hovering overhead. The deconstructed design separates the LED light source from its translucent shades, producing gradations of diffuse illumination.

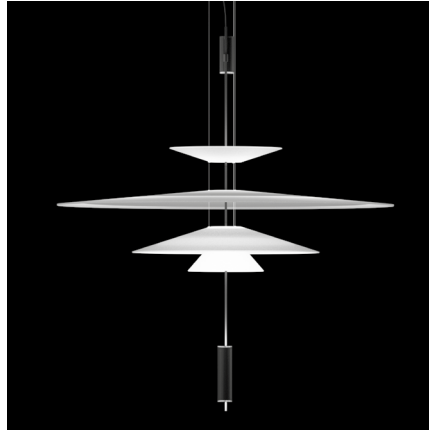
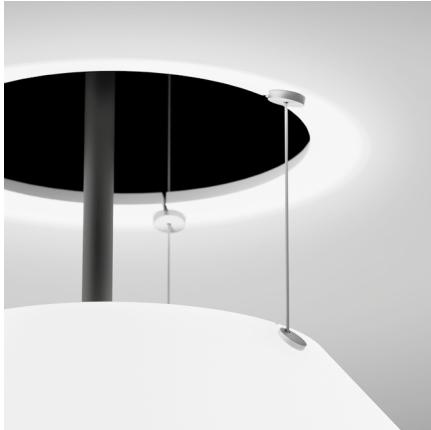

Pendants

<p>1510</p>	<p>Light Source</p> <p>2 x LED 5,6W 500mA. Led 2700 K. CRI >80. 1389 lm. 124 lm/W. Driver Constant Current 500mA. 110-240V. 50/60Hz. Dimming: 1-10V, Push.</p> <p>Personalization options available</p> <ul style="list-style-type: none"> - LED 3000 K / 4000 K. - Dimming: DALI or Casambi. - Extra cable length. <p>Min. quantity, upcharge and extra lead time apply.</p>	<p>Materials</p> <p>Diffuser: Methacrylate. Shade: Acrylic. Body: Aluminum. Canopy and rods: Steel.</p> <p>Packaging</p> <p>2 Boxes. Total Vol. 0,0620 m³. Gross weight 6,7 Kg. Net weight 4,7 Kg.</p>	<p>1510 18 /1B Graphite (RAL 7016)</p> <p>1510 20 /1B Gold (Gold)</p> <p>1510 67 /1B Copper (Copper)</p> <p>1510 93 /1B White (RAL 9016)</p> <p>EAC LED IP20 CE Bi-volt A**</p>
<p>1515</p>	<p>Light Source</p> <p>2 x LED 5,6W 500mA. Led 2700 K. CRI >80. 1389 lm. 124 lm/W. Driver Constant Current 500mA. 110-240V. 50/60Hz.</p> <p>Dimmer on the cable. Electric cable 2,5 m.</p> <p>Personalization options available</p> <ul style="list-style-type: none"> - LED 3000 K / 4000 K. - Extra cable length. <p>Min. quantity, upcharge and extra lead time apply.</p>	<p>Materials</p> <p>Diffuser: Methacrylate. Shade: Acrylic. Body: Aluminum. Canopy and rods: Steel.</p> <p>Packaging</p> <p>2 Boxes. Total Vol. 0,0620 m³. Gross weight 7,2 Kg. Net weight 5,2 Kg.</p>	<p>1515 18 /15 Graphite (RAL 7016)</p> <p>1515 20 /15 Gold (Gold)</p> <p>1515 67 /15 Copper (Copper)</p> <p>1515 93 /15 White (RAL 9016)</p> <p>EAC LED IP20 CE Bi-volt A**</p>
<p>1527</p> <p>New</p>	<p>Light Source</p> <p>2 x LED 5,6W 500mA. Led 2700 K. CRI >80. 1389 lm. 124 lm/W. Driver Constant Current 500mA. 110-240V. 50/60Hz. Dimming: 1-10V, Push.</p> <p>Personalization options available</p> <ul style="list-style-type: none"> - LED 3000 K / 4000 K. - Dimming: DALI or Casambi. - Extra cable length. <p>Min. quantity, upcharge and extra lead time apply.</p>	<p>Materials</p> <p>Diffuser: Methacrylate. Shade: Acrylic. Body: Aluminum. Canopy and rods: Steel.</p> <p>Packaging</p> <p>1 Box. 0,12 x 0,80 x 0,79 m. Vol. 0,0634 m³. Gross weight 4,1 Kg. Net weight 3,69 Kg.</p>	<p>1527 18 /1B Graphite (RAL 7016)</p> <p>1527 20 /1B Gold (Gold)</p> <p>1527 67 /1B Copper (Copper)</p> <p>1527 93 /1B White (RAL 9016)</p> <p>EAC LED IP20 CE Bi-volt A**</p>

Flamingo

1530

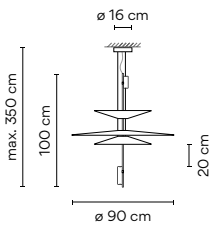

Light Source

3 x LED 5,6W 500mA.
Led 2700 K. CRI >80. 2083,3 lm. 124 lm/W.
Driver Constant Current 500mA.
 220-240V. 50/60Hz.
Dimming: 1-10V, Push.

Personalization options available

- LED 3000 K / 4000 K.
 - Dimming: DALI or Casambi.
 - Extra cable length.
 Min. quantity, upcharge and extra lead time apply.

Materials

Diffuser: Methacrylate.
 Shade: Acrylic.
 Body: Aluminum.
 Canopy and rods: Steel.

Packaging

3 Boxes.
 Total Vol. 0,1520 m³.
 Gross weight 10 Kg.
 Net weight 7 Kg.

1530 18 /1B Graphite
 (RAL 7016)

1530 20 /1B Gold
 (Gold)

1530 67 /1B Copper
 (Copper)

1530 93 /1B White
 (RAL 9016)



1540

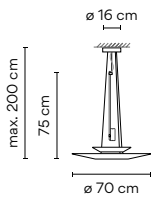

Light Source

1 x LED 5,6W 500mA.
Led 2700 K. CRI >80. 694,4 lm. 124 lm/W.
Driver Constant Current 500mA.
 110-240V. 50/60Hz.
Dimming: 1-10V, Push.

Personalization options available

- LED 3000 K / 4000 K.
 - Dimming: DALI or Casambi.
 - Extra cable length.
 Min. quantity, upcharge and extra lead time apply.

Materials

Diffuser: Methacrylate.
 Shade: Acrylic.
 Body: Aluminum.
 Canopy and rods: Steel.

Packaging

2 Boxes.
 Total Vol. 0,0620 m³.
 Gross weight 6 Kg.
 Net weight 4 Kg.

1540 18 /1B Graphite
 (RAL 7016)

1540 20 /1B Gold
 (Gold)

1540 67 /1B Copper
 (Copper)

1540 93 /1B White
 (RAL 9016)

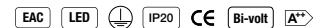

1550

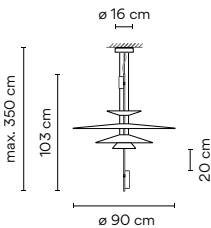

Light Source

3 x LED 5,6W 500mA.
Led 2700 K. CRI >80. 2083,3 lm. 124 lm/W.
Driver Constant Current 500mA.
 220-240V. 50/60Hz.
Dimming: 1-10V, Push.

Personalization options available

- LED 3000 K / 4000 K.
 - Dimming: DALI or Casambi.
 - Extra cable length.
 Min. quantity, upcharge and extra lead time apply.

Materials

Diffuser: Methacrylate.
 Shade: Acrylic.
 Body: Aluminum.
 Canopy and rods: Steel.

Packaging

3 Boxes.
 Total Vol. 0,1520 m³.
 Gross weight 11,3 Kg.
 Net weight 8,8 Kg.

1550 18 /1B Graphite
 (RAL 7016)

1550 20 /1B Gold
 (Gold)

1550 67 /1B Copper
 (Copper)

1550 93 /1B White
 (RAL 9016)



1560

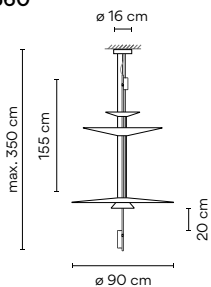

Light Source

3 x LED 5,6W 500mA.
Led 2700 K. CRI >80. 2083,3 lm. 124 lm/W.
Driver Constant Current 500mA.
 220-240V. 50/60Hz.
Dimming: 1-10V, Push.

Personalization options available

- LED 3000 K / 4000 K.
 - Dimming: DALI or Casambi.
 - Extra cable length.
 Min. quantity, upcharge and extra lead time apply.

Materials

Diffuser: Methacrylate.
 Shade: Acrylic.
 Body: Aluminum.
 Canopy and rods: Steel.

Packaging

3 Boxes.
 Total Vol. 0,1860 m³.
 Gross weight 12,7 Kg.
 Net weight 10,2 Kg.

1560 18 /1B Graphite
 (RAL 7016)

1560 20 /1B Gold
 (Gold)

1560 67 /1B Copper
 (Copper)

1560 93 /1B White
 (RAL 9016)



1570

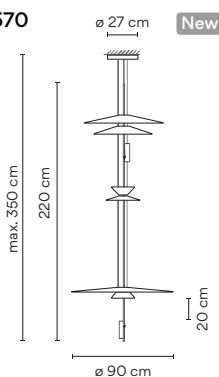

Light Source

4 x LED 5,6W 500mA.
Led 2700 K. CRI >80. 2777 lm. 124 lm/W.
Driver Constant Current 500mA.
 110-240V. 50/60Hz.
Dimming: 1-10V, Push.

Personalization options available

- LED 3000 K / 4000 K.
 - Dimming: DALI or Casambi.
 - Extra cable length.
 Min. quantity, upcharge and extra lead time apply.

Materials

Diffuser: Methacrylate.
 Shade: Acrylic.
 Body: Aluminum.
 Canopy and rods: Steel.

Packaging

2 Boxes.
 Total Vol. 0,1633 m³.
 Gross weight 10 Kg.
 Net weight 8,64 Kg.

1570 18 /1B Graphite
 (RAL 7016)

1570 20 /1B Gold
 (Gold)

1570 67 /1B Copper
 (Copper)

1570 93 /1B White
 (RAL 9016)



Pin

Design by Ichiro Iwasaki

Through the exploration of “eternal comfort” in lighting environments PIN aims to provide something new and original yet in harmony with both the old and the contemporary.

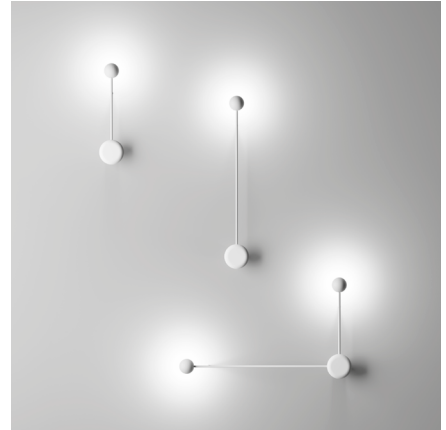

Table

<p>1650</p>	<p>Light Source</p> <p>1 x LED 4,5W 350mA. Led 2700 K. CRI >80. 490 lm. 109 lm/W. Driver Constant Current 350mA. 100-240V. 50/60Hz.</p> <p>Switch on the base. Electric cable 3 m.</p> <p>Personalization options available - Finish customization. (Available options: Vibia color palette). Min. quantity, upcharge and extra lead time apply.</p>	<p>Materials Head: Aluminum. Base: Zamak. Diffuser: Polycarbonate. Rod: Steel.</p> <p>Packaging 1 Box. 0,174 x 0,212 x 0,713 m. Vol. 0,0212 m³. Gross weight 2,94 Kg. Net weight 2 Kg.</p>	<p>1650 04 /10 Black (NCS 9000N)</p> <hr/> <p>1650 58 /10 Cream (NCS S 2005-Y20R)</p> <hr/> <p>1650 62 /10 Green (NCS S 3010-G20Y)</p> <hr/> <p>1650 93 /10 White (NCS S 0502-Y)</p> <hr/> <p>EAC LED IP20 CE Bi-volt A*</p>
<p>1655</p>	<p>Light Source</p> <p>1 x LED 4,5W 350mA. Led 2700 K. CRI >80. 490 lm. 109 lm/W. Driver Constant Current 350mA. 100-240V. 50/60Hz.</p> <p>Switch on the base. Electric cable 3 m.</p> <p>Personalization options available - Finish customization. (Available options: Vibia color palette). Min. quantity, upcharge and extra lead time apply.</p>	<p>Materials Head: Aluminum. Base: Zamak. Diffuser: Polycarbonate. Rod: Steel.</p> <p>Packaging 1 Box. 0,20 x 0,357 x 0,67 m. Vol. 0,0480 m³. Gross weight 3,68 Kg. Net weight 2,2 Kg.</p>	<p>1655 04 /10 Black (NCS 9000N)</p> <hr/> <p>1655 58 /10 Cream (NCS S 2005-Y20R)</p> <hr/> <p>1655 62 /10 Green (NCS S 3010-G20Y)</p> <hr/> <p>1655 93 /10 White (NCS S 0502-Y)</p> <hr/> <p>EAC LED IP20 CE Bi-volt A*</p>
<p>1660</p>	<p>Light Source</p> <p>1 x LED 4,5W 350mA. Led 2700 K. CRI >80. 490 lm. 109 lm/W. Driver Constant Current 350mA. 100-240V. 50/60Hz.</p> <p>Switch on the base. Electric cable 3 m.</p> <p>Personalization options available - Finish customization. (Available options: Vibia color palette). Min. quantity, upcharge and extra lead time apply.</p>	<p>Materials Head: Aluminum. Base: Zamak. Diffuser: Polycarbonate. Rod: Steel.</p> <p>Packaging 1 Box. 0,149 x 0,265 x 0,33 m. Vol. 0,1310 m³. Gross weight 7,45 Kg. Net weight 3,8 Kg.</p>	<p>1660 04 /10 Black (NCS 9000N)</p> <hr/> <p>1660 58 /10 Cream (NCS S 2005-Y20R)</p> <hr/> <p>1660 62 /10 Green (NCS S 3010-G20Y)</p> <hr/> <p>1660 93 /10 White (NCS S 0502-Y)</p> <hr/> <p>EAC LED IP20 CE Bi-volt A*</p>

Floor

1665

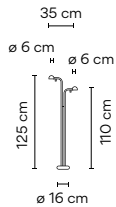

Light Source



1 x LED 4,5W 350mA.
Led 2700 K. CRI >80. 980,5 lm. 109 lm/W.
Driver Constant Current 350mA.
 100-240V. 50/60Hz.

Switch on the base. Electric cable 3 m.

Personalization options available
 - Finish customization.
 (Available options: Vibia color palette).
 Min. quantity, upcharge and extra lead time apply.

Materials

Head: Aluminum.
 Base: Zamak.
 Diffuser: Polycarbonate.
 Rod: Steel.

Packaging

1 Box.
 1,496 x 0,265 x 0,33 m.
 Vol. 0,1310 m³.
 Gross weight 8,25 Kg.
 Net weight 4,6 Kg.

1665 04 /10 Black
 (NCS 9000N)

1665 58 /10 Cream
 (NCS S 2005-Y20R)

1665 62 /10 Green
 (NCS S 3010-G20Y)

1665 93 /10 White
 (NCS S 0502-Y)



1670

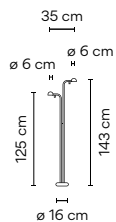

Light Source



2 x LED 4,5W 350mA.
Led 2700 K. CRI >80. 980,5 lm. 109 lm/W.
Driver Constant Current 350mA.
 100-240V. 50/60Hz.

Switch on the base. Electric cable 3 m.

Personalization options available
 - Finish customization.
 (Available options: Vibia color palette).
 Min. quantity, upcharge and extra lead time apply.

Materials

Head: Aluminum.
 Base: Zamak.
 Diffuser: Polycarbonate.
 Rod: Steel.

Packaging

1 Box.
 1,496 x 0,265 x 0,33 m.
 Vol. 0,1310 m³.
 Gross weight 8,45 Kg.
 Net weight 4,8 Kg.

1670 04 /10 Black
 (NCS 9000N)

1670 58 /10 Cream
 (NCS S 2005-Y20R)

1670 62 /10 Green
 (NCS S 3010-G20Y)

1670 93 /10 White
 (NCS S 0502-Y)

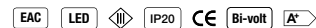

Wall

1675

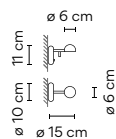

Light Source



1 x LED 4,5W 350mA.
Led 2700 K. CRI >80. 490 lm. 109 lm/W.
Driver Constant Current 350mA.
 100-240V. 50/60Hz.

Switch on the wall plate.

Personalization options available
 - Finish customization.
 (Available options: Vibia color palette).
 Min. quantity, upcharge and extra lead time apply.

Materials

Head: Aluminum.
 Base: Zamak.
 Diffuser: Polycarbonate.
 Rod: Steel.

Packaging

1 Box.
 0,193 x 0,148 x 0,161 m.
 Vol. 0,0046 m³.
 Gross weight 0,85 Kg.
 Net weight 0,6 Kg.

1675 04 /10 Black
 (NCS 9000N)

1675 58 /10 Cream
 (NCS S 2005-Y20R)

1675 62 /10 Green
 (NCS S 3010-G20Y)

1675 93 /10 White
 (NCS S 0502-Y)

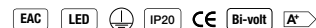

1680

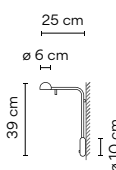

Light Source



1 x LED 4,5W 350mA.
Led 2700 K. CRI >80. 490 lm. 109 lm/W.
Driver Constant Current 350mA.
 100-240V. 50/60Hz.

Switch on the wall plate.

Personalization options available
 - Finish customization.
 (Available options: Vibia color palette).
 Min. quantity, upcharge and extra lead time apply.

Materials

Head: Aluminum.
 Base: Zamak.
 Diffuser: Polycarbonate.
 Rod: Steel.

Packaging

1 Box.
 0,146 x 0,355 x 0,473 m.
 Vol. 0,0250 m³.
 Gross weight 1,745 Kg.
 Net weight 1 Kg.

1680 04 /10 Black
 (NCS 9000N)

1680 58 /10 Cream
 (NCS S 2005-Y20R)

1680 62 /10 Green
 (NCS S 3010-G20Y)

1680 93 /10 White
 (NCS S 0502-Y)

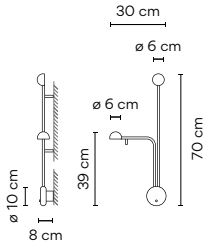
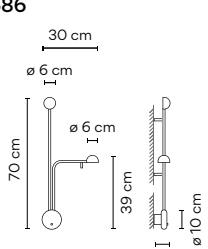
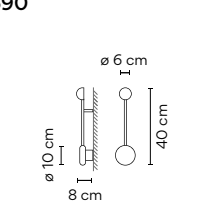
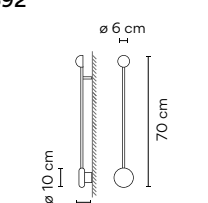
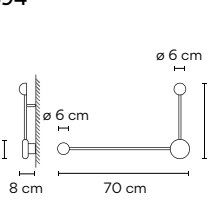

<p>1685</p> 	<p>Light Source</p> <p>2 x LED 4,5W 350mA. Led 2700 K. CRI >80. 980,5 lm. 109 lm/W. Driver Constant Current 350mA. 100-240V. 50/60Hz.</p> <p>Switch on the wall plate.</p> <p>Personalization options available - Finish customization. (Available options: Vibia color palette). Min. quantity, upcharge and extra lead time apply.</p>	<p>Materials Head: Aluminum. Base: Zamak. Diffuser: Polycarbonate. Rod: Steel.</p> <p>Packaging 1 Box. 0,177 x 0,445 x 0,792 m. Vol. 0,0620 m³. Gross weight 2,64 Kg. Net weight 1,2 Kg.</p>	<p>1685 04 /10 Black (NCS 9000N)</p> <p>1685 58 /10 Cream (NCS S 2005-Y20R)</p> <p>1685 62 /10 Green (NCS S 3010-G20Y)</p> <p>1685 93 /10 White (NCS S 0502-Y)</p> <p>EAC LED IP20 CE Bi-volt A*</p>
<p>1686</p> 	<p>Light Source</p> <p>2 x LED 4,5W 350mA. Led 2700 K. CRI >80. 980,5 lm. 109 lm/W. Driver Constant Current 350mA. 100-240V. 50/60Hz.</p> <p>Switch on the wall plate.</p> <p>Personalization options available - Finish customization. (Available options: Vibia color palette). Min. quantity, upcharge and extra lead time apply.</p>	<p>Materials Head: Aluminum. Base: Zamak. Diffuser: Polycarbonate. Rod: Steel.</p> <p>Packaging 1 Box. 0,177 x 0,445 x 0,792 m. Vol. 0,0620 m³. Gross weight 2,64 Kg. Net weight 1,2 Kg.</p>	<p>1686 04 /10 Black (NCS 9000N)</p> <p>1686 58 /10 Cream (NCS S 2005-Y20R)</p> <p>1686 62 /10 Green (NCS S 3010-G20Y)</p> <p>1686 93 /10 White (NCS S 0502-Y)</p> <p>EAC LED IP20 CE Bi-volt A*</p>
<p>1690</p> 	<p>Light Source</p> <p>1 x LED 4,5W 350mA. Led 2700 K. CRI >80. 490 lm. 109 lm/W. Driver Constant Current 350mA. 100-240V. 50/60Hz.</p> <p>Personalization options available - Finish customization. (Available options: Vibia color palette). Min. quantity, upcharge and extra lead time apply.</p>	<p>Materials Head: Aluminum. Base: Zamak. Diffuser: Polycarbonate. Rod: Steel.</p> <p>Packaging 1 Box. 0,146 x 0,355 x 0,473 m. Vol. 0,0250 m³. Gross weight 1,545 Kg. Net weight 0,8 Kg.</p>	<p>1690 04 /10 Black (NCS 9000N)</p> <p>1690 58 /10 Cream (NCS S 2005-Y20R)</p> <p>1690 62 /10 Green (NCS S 3010-G20Y)</p> <p>1690 93 /10 White (NCS S 0502-Y)</p> <p>EAC LED IP20 CE Bi-volt A*</p>
<p>1692</p> 	<p>Light Source</p> <p>1 x LED 4,5W 350mA. Led 2700 K. CRI >80. 490 lm. 109 lm/W. Driver Constant Current 350mA. 100-240V. 50/60Hz.</p> <p>Personalization options available - Finish customization. (Available options: Vibia color palette). Min. quantity, upcharge and extra lead time apply.</p>	<p>Materials Head: Aluminum. Base: Zamak. Diffuser: Polycarbonate. Rod: Steel.</p> <p>Packaging 1 Box. 0,177 x 0,445 x 0,792 m. Vol. 0,0620 m³. Gross weight 2,44 Kg. Net weight 1 Kg.</p>	<p>1692 04 /10 Black (NCS 9000N)</p> <p>1692 58 /10 Cream (NCS S 2005-Y20R)</p> <p>1692 62 /10 Green (NCS S 3010-G20Y)</p> <p>1692 93 /10 White (NCS S 0502-Y)</p> <p>EAC LED IP20 CE Bi-volt A*</p>
<p>1694</p> 	<p>Light Source</p> <p>2 x LED 4,5W 350mA. Led 2700 K. CRI >80. 980,5 lm. 109 lm/W. Driver Constant Current 350mA. 100-240V. 50/60Hz.</p> <p>Personalization options available - Finish customization. (Available options: Vibia color palette). Min. quantity, upcharge and extra lead time apply.</p>	<p>Materials Head: Aluminum. Base: Zamak. Diffuser: Polycarbonate. Rod: Steel.</p> <p>Packaging 1 Box. 0,177 x 0,445 x 0,792 m. Vol. 0,0620 m³. Gross weight 2,84 Kg. Net weight 1,4 Kg.</p>	<p>1694 04 /10 Black (NCS 9000N)</p> <p>1694 58 /10 Cream (NCS S 2005-Y20R)</p> <p>1694 62 /10 Green (NCS S 3010-G20Y)</p> <p>1694 93 /10 White (NCS S 0502-Y)</p> <p>EAC LED IP20 CE Bi-volt A*</p>

Funnel

A fluid design defines this ceiling fixture, a streamlined, funnel-shaped base that flows into a protruding cap. The smooth, sculptural curves conceal a light source behind the tip, which reflects back on the funnel form and creates a flood of ambient illumination.

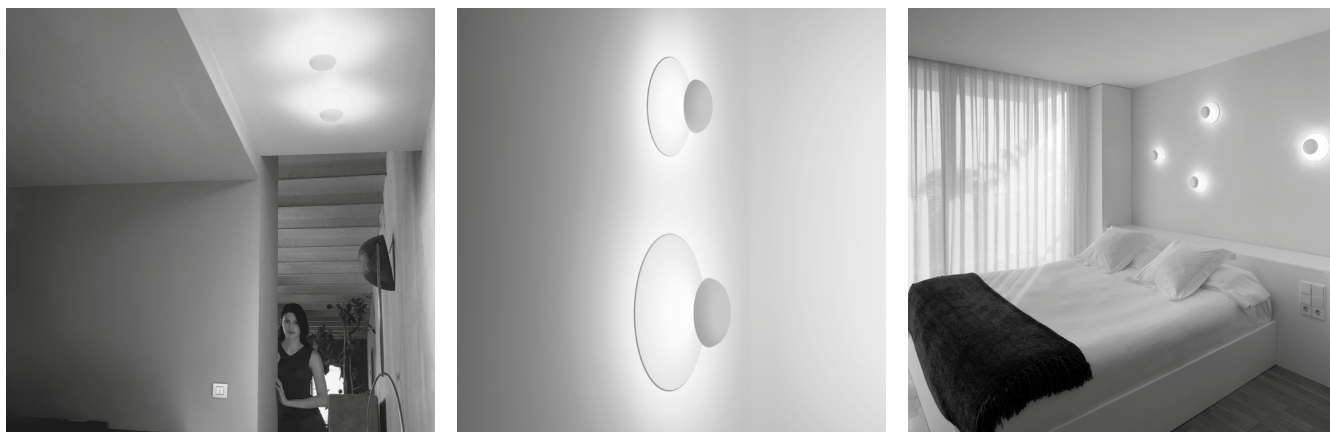

Ceiling Wall

2004

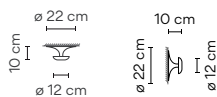

Light Source



2 x G9 230V 60W Eco Max.

Materials

Shade: Aluminum.
Reflector: Aluminum.
Support: Steel.

Packaging

1 Box.
0,27 x 0,27 x 0,16 m.
Vol. 0,0116 m³.
Gross weight 0,892 Kg.
Net weight 0,45 Kg.

2004 03 Gloss white (RAL 9003)
UNTIL STOCK RUNS OUT

2004 10 White
(NCS S 0300-N)

2004 36 Soft Pink
(NCS S 1010-Y50R)

2004 47 Green L1
(NCS S 4005-G80Y)

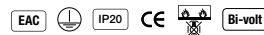

2005

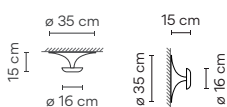

Light Source



3 x G9 230V 48W Eco Max.

Materials

Shade: Aluminum.
Reflector: Aluminum.
Support: Steel.

Packaging

1 Box.
0,25 x 0,42 x 0,42 m.
Vol. 0,0441 m³.
Gross weight 2,532 Kg.
Net weight 2,0 Kg.

2005 03 Gloss white (RAL 9003)
UNTIL STOCK RUNS OUT

2005 10 White
(NCS S 0300-N)

2005 36 Soft Pink
(NCS S 1010-Y50R)

2005 47 Green L1
(NCS S 4005-G80Y)

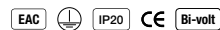

Funnel

2007

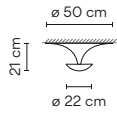

Light Source

3 x R7s 80mm 230V 80WEco.

Materials

Shade: Aluminum.
Reflector: Aluminum.
Support: Steel.

Packaging

1 Box.
0,27 x 0,60 x 0,60 m.
Vol. 0,0972 m³.
Gross weight 3,782 Kg.
Net weight 3,3 Kg.

2007 03 Gloss white (RAL 9003)

UNTIL STOCK RUNS OUT

2007 10 White
(NCS S 0300-N)

2007 36 Soft Pink
(NCS S 1010-Y50R)

2007 47 Green L1
(NCS S 4005-G80Y)

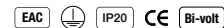

2012

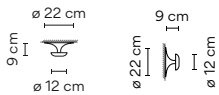

Light Source

1 x LED PLATE 6,3W 350mA.
Led 2700 K. CRI >80. 631,7 lm. 100,3 lm/W.
Driver Constant Current 350mA.
100-240V. 50/60Hz.

Personalization options available

- Finish customization.
(Available options: Vibia color palette).
- LED 3000 K / 4000 K.
Min. quantity, upcharge and extra lead time apply.

Materials

Shade: Aluminum.
Reflector: Aluminum.
Support: Steel.

Packaging

1 Box.
0,27 x 0,27 x 0,16 m.
Vol. 0,0116 m³.
Gross weight 0,892 Kg.
Net weight 0,45 Kg.

2012 10 /10 White
(NCS S 0300-N)

2012 36 /10 Soft Pink
(NCS S 1010-Y50R)

2012 47 /10 Green L1
(NCS S 4005-G80Y)

2012 51 /10 Gold leaf
(Gold leaf)

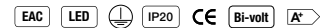

2013

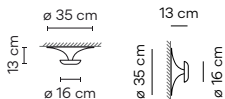

Light Source

6 x LED 4,5W 350mA.
Led 2700 K. CRI >80. 2941,6 lm. 108,9 lm/W.
Driver Constant Current 350mA.
110-240V. 50/60Hz.
Dimming: 1-10V, DALI, Push.

Personalization options available

- Finish customization.
(Available options: Vibia color palette).
- LED 3000 K / 4000 K.
Min. quantity, upcharge and extra lead time apply.

Materials

Shade: Aluminum.
Reflector: Aluminum.
Support: Steel.

Packaging

1 Box.
0,25 x 0,42 x 0,42 m.
Vol. 0,0441 m³.
Gross weight 2,53 Kg.
Net weight 2 Kg.

2013 10 /1A White
(NCS S 0300-N)

2013 36 /1A Soft Pink
(NCS S 1010-Y50R)

2013 47 /1A Green L1
(NCS S 4005-G80Y)

2013 51 /1A Gold leaf
(Gold leaf)

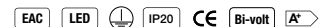

2014

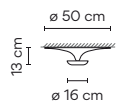

Light Source

6 x LED 4,5W 350mA.
Led 2700 K. CRI >80. 2941,6 lm. 108,9 lm/W.
Driver Constant Current 350mA.
110-240V. 50/60Hz.
Dimming: 1-10V, DALI, Push.

Personalization options available

- Finish customization.
(Available options: Vibia color palette).
- LED 3000 K / 4000 K.
- Dimming: Casambi.
Min. quantity, upcharge and extra lead time apply.

Materials

Shade: Aluminum.
Reflector: Aluminum.
Support: Steel.

Packaging

1 Box.
0,27 x 0,60 x 0,60 m.
Vol. 0,0972 m³.
Gross weight 3,782 Kg.
Net weight 3,3 Kg.

2014 10 /1A White
(NCS S 0300-N)

2014 36 /1A Soft Pink
(NCS S 1010-Y50R)

2014 47 /1A Green L1
(NCS S 4005-G80Y)

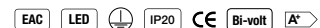

Micro

Design by Ramos & Bassols

Like an eclipse, just at that moment when the moon passes over the sun leaving only a ring of light.

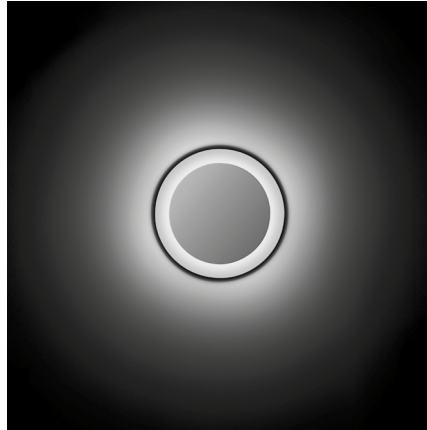

Wall Outdoor

2015



Light Source



3 x LED 1 W 350mA.
Led 2700 K. CRI >80. 365,2 lm. 122 lm/W.
Driver Constant Current 350mA.
100-240V. 50/60Hz.

Surface fitting.

Personalization options available

- LED 3000 K / 4000 K.
Min. quantity, upcharge and extra lead time apply.

Materials

Body: Aluminum.
Diffuser: Polycarbonate.

Packaging

1 Box.
0,13 x 0,20 x 0,212 m.
Vol. 0,0050 m³.
Gross weight 1,1 Kg.
Net weight 0,7 Kg.

2015 03 /10 White
(RAL 9016)

2015 54 /10 Oxide
(RAL 8017)

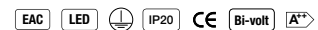

Rhythm Horizontal

Design by Arik Levy

Evoking the mood of Zen minimalism, Rhythm features slender light modules of varying lengths, each fitted with an LED module, that can be arranged in endless configurations. Fluid and flowing or angular and anarchic, Rhythm represents the ultimate in customised lighting.



Create your product configuration quickly and easily at vibia.com

Go to vibia.com and discover the quickest, most effective way to configure a unique Rhythm luminaire design.

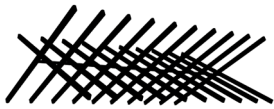

Pendants

2110

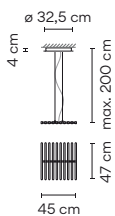

Light Source

10 x LED STRIP 30V 2,9W.
Led 2700 K. CRI >80. 3460 lm. 119 lm/W.
Driver Constant Voltage 30V.
 100-240V. 50/60Hz.
Dimming: 1-10V.

Surface and built-in fitting.

Personalization options available

- Configuration layout at vibia.com
 - LED 3000 K / 4000 K.
 - Dimming: DALI or Casambi.
- Min. quantity, upcharge and extra lead time apply.

Materials

Stick: Polyamide 6 with 10% of Fiberglass.
 Diffuser: Polycarbonate.
 Canopy: Steel.

Packaging

2 Boxes.
 Total Vol. 0,0591 m³.
 Gross weight 7,7 Kg.
 Net weight 6 Kg.

2110 14 /13 Chocolate
 (RAL 8019)

2110 58 /13 Off-white
 (RAL D2 1109005)

2191-14 Built-in accessory
 (96 mm) chocolate

2191-58 Built-in accessory
 (96 mm) off-white

EAC LED IP20 CE Bi-volt  ø 18,5 cm  **A**
 Only for built-in.

Rhythm Horizontal

2111

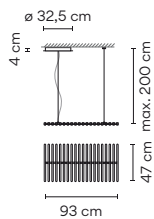

Light Source

20 x LED STRIP 30V 2,9W.
Led 2700 K. CRI >80. 6920 lm. 119 lm/W.
Driver Constant Voltage 30V.
 100-240V. 50/60Hz.
Dimming: 1-10V.

Surface and built-in fitting.

Personalization options available

- Configuration layout at vibia.com
- LED 3000 K / 4000 K.
- Dimming: DALI or Casambi.

Min. quantity, upcharge and extra lead time apply.

Materials

Stick: Polyamide 6 with 10% of Fiberglass.
 Diffuser: Polycarbonate.
 Canopy: Steel.

Packaging

2 Boxes.
 Total Vol. 0,0430 m³.
 Gross weight 10,3 Kg.
 Net weight 7 Kg.

2111 14 /13 Chocolate
 (RAL 8019)

2111 58/13 Off-white
 (RAL D2 1109005)

2190-14 Built-in accessory
 (96 mm) chocolate

2190-58 Built-in accessory
 (96 mm) off-white

EAC LED IP20 CE Bi-volt  ø 18,5 cm 
 Only for built-in.

2112

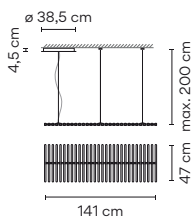

Light Source

30 x LED STRIP 30V 2,9W.
Led 2700 K. CRI >80. 10380 lm. 119 lm/W.
Driver Constant Voltage 30V.
 100-240V. 50/60Hz.
Dimming: 1-10V.

Surface and built-in fitting.

Personalization options available

- Configuration layout at vibia.com
- LED 3000 K / 4000 K.
- Dimming: DALI or Casambi.

Min. quantity, upcharge and extra lead time apply.

Materials

Stick: Polyamide 6 with 10% of Fiberglass.
 Diffuser: Polycarbonate.
 Canopy: Steel.

Packaging

2 Boxes.
 Total Vol. 0,1570 m³.
 Gross weight 14,2 Kg.
 Net weight 10,5 Kg.

2112 14 /13 Chocolate
 (RAL 8019)

2112 58/13 Off-white
 (RAL D2 1109005)

2190-14 Built-in accessory
 (44,5 mm) chocolate

2190-58 Built-in accessory
 (44,5 mm) off-white

EAC LED IP20 CE Bi-volt  ø 18,5 cm 
 Only for built-in.

2113

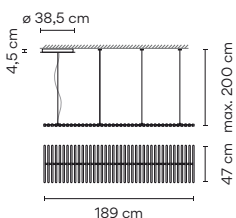

Light Source

40 x LED STRIP 30V 2,9W.
Led 2700 K. CRI >80. 13840 lm. 119 lm/W.
Driver Constant Voltage 30V.
 100-240V. 50/60Hz.
Dimming: 1-10V.

Surface and built-in fitting.

Personalization options available

- Configuration layout at vibia.com
- LED 3000 K / 4000 K.
- Dimming: DALI or Casambi.

Min. quantity, upcharge and extra lead time apply.

Materials

Stick: Polyamide 6 with 10% of Fiberglass.
 Diffuser: Polycarbonate.
 Canopy: Steel.

Packaging

2 Boxes.
 Total Vol. 0,1900 m³.
 Gross weight 17,2 Kg.
 Net weight 13,5 Kg.

2113 14 /13 Chocolate
 (RAL 8019)

2113 58 /13 Off-white
 (RAL D2 1109005)

2190-14 Built-in accessory
 (44,5 mm) chocolate

2190-58 Built-in accessory
 (44,5 mm) off-white

EAC LED IP20 CE Bi-volt  ø 18,5 cm 
 Only for built-in.

Rhythm Horizontal

2120

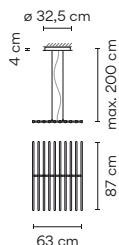

Light Source

10 x LED STRIP 30V 5,8W.
Led 2700 K. CRI >80. 6920 lm. 119 lm/W.
Driver Constant Voltage 30V.
 100-240V. 50/60Hz.
Dimming: 1-10V.

Surface and built-in fitting.

Personalization options available

- Configuration layout at vibia.com
 - LED 3000 K / 4000 K.
 - Dimming: DALI or Casambi.
- Min. quantity, upcharge and extra lead time apply.

Materials

Stick: Polyamide 6 with 10% of Fiberglass.
 Diffuser: Polycarbonate.
 Canopy: Steel.

Packaging

2 Boxes.
 Total Vol. 0,1380 m³.
 Gross weight 9,5 Kg.
 Net weight 7,3 Kg.

2120 14 /13 Chocolate
 (RAL 8019)

2120 58 /13 Off-white
 (RAL D2 1109005)

2192-14 Built-in accessory
 (136 mm) chocolate

2192-58 Built-in accessory
 (136 mm) off-white



2121

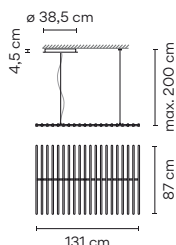

Light Source

20 x LED STRIP 30V 5,8W.
Led 2700 K. CRI >80. 13840 lm. 119 lm/W.
Driver Constant Voltage 30V.
 100-240V. 50/60Hz.
Dimming: 1-10V.

Surface and built-in fitting.

Personalization options available

- Configuration layout at vibia.com
 - LED 3000 K / 4000 K.
 - Dimming: DALI or Casambi.
- Min. quantity, upcharge and extra lead time apply.

Materials

Stick: Polyamide 6 with 10% of Fiberglass.
 Diffuser: Polycarbonate.
 Canopy: Steel.

Packaging

2 Boxes.
 Total Vol. 0,1664 m³.
 Gross weight 14,7 Kg.
 Net weight 10,5 Kg.

2121 14 /13 Chocolate
 (RAL 8019)

2121 58 /13 Off-white
 (RAL D2 1109005)

2190-14 Built-in accessory
 (44,5 mm) chocolate

2190-58 Built-in accessory
 (44,5 mm) off-white



2122

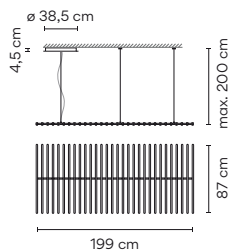

Light Source

30 x LED STRIP 30V 5,8W.
Led 2700 K. CRI >80. 20760 lm. 119 lm/W.
Driver Constant Voltage 30V.
 100-240V. 50/60Hz.
Dimming: 1-10V.

Surface and built-in fitting.

Personalization options available

- Configuration layout at vibia.com
 - LED 3000 K / 4000 K.
- Min. quantity, upcharge and extra lead time apply.

Materials

Stick: Polyamide 6 with 10% of Fiberglass.
 Diffuser: Polycarbonate.
 Canopy: Steel.

Packaging

2 Boxes.
 Total Vol. 0,07120 m³.
 Gross weight 24 Kg.
 Net weight 21,5 Kg.

2122 14 /13 Chocolate
 (RAL 8019)

2122 58 /13 Off-white
 (RAL D2 1109005)

2190-14 Built-in accessory
 (44,5 mm) chocolate

2190-58 Built-in accessory
 (44,5 mm) off-white



Rhythm Vertical

Design by Arik Levy

Evoking the mood of Zen minimalism, Rhythm features slender light modules of varying lengths, each fitted with an LED module, that can be arranged in endless configurations. Fluid and flowing or angular and anarchic, Rhythm represents the ultimate in customised lighting.



Create your product configuration quickly and easily at vibia.com

Go to vibia.com and discover the quickest, most effective way to configure a unique Rhythm luminaire design.

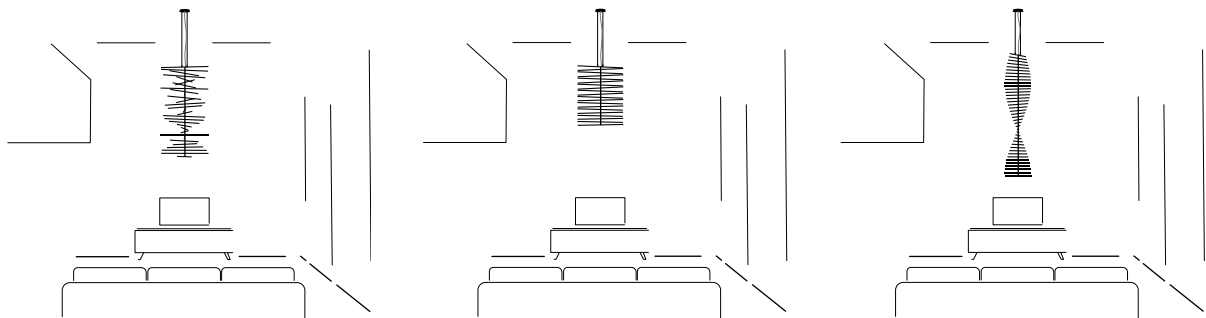

Pendants

2141

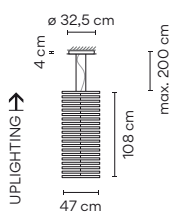

Light Source

20 x LED STRIP 30V 2,9W.
Led 2700 K. CRI >80. 6920 lm. 119 lm/W.
Driver Constant Voltage 30V.
 100-240V. 50/60Hz.
Dimming: 1-10V.

Surface and built-in fitting.

Personalization options available

- Configuration layout at vibia.com
 - LED 3000 K / 4000 K.
 - Dimming: DALI or Casambi.
- Min. quantity, upcharge and extra lead time apply.

Materials

Stick: Polyamide 6 with 10% of Fiberglass.
 Diffuser: Polycarbonate.
 Canopy: Steel.

Packaging

2 Boxes.
 Total Vol. 0,5850 m³.
 Gross weight 10,3 Kg.
 Net weight 7,4 Kg.

2141 14 /13 Chocolate
 (RAL 8019)

2141 58 /13 Off-white
 (RAL D2 1109005)

2191-14 Built-in accessory
 (96mm) chocolate

2191-58 Built-in accessory
 (96mm) off-white

EAC LED IP20 CE Bi-volt \varnothing 18,5 cm Δ
 Only for built-in.

Rhythm Vertical

2142

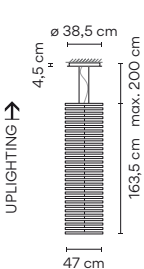

Light Source

30 x LED STRIP 30V 2,9W.
Led 2700 K. CRI >80. 10380 lm. 119 lm/W.
Driver Constant Voltage 30V.
 100-240V. 50/60Hz.
Dimming: 1-10V.

Surface and built-in fitting.

Personalization options available

- Configuration layout at vibia.com
- LED 3000 K / 4000 K.
- Dimming: DALI or Casambi.

Min. quantity, upcharge and extra lead time apply.



Materials

Stick: Polyamide 6 with 10% of Fiberglass.
 Diffuser: Polycarbonate.
 Canopy: Steel.

Packaging

2 Boxes.
 Total Vol. 0,6239 m³.
 Gross weight 13,7 Kg.
 Net weight 8,2 Kg.

2142 14 /13 Chocolate (RAL 8019)
2142 58 /13 Off-white (RAL D2 1109005)
2191-14 Built-in accessory (96mm) chocolate
2191-58 Built-in accessory (96mm) off-white

EAC LED IP20 CE Bi-volt  ø 18,5 cm 
 Only for built-in.

2143



Light Source

40 x LED STRIP 30V 2,9W.
Led 2700 K. CRI >80. 13840 lm. 119 lm/W.
Driver Constant Voltage 30V.
 100-240V. 50/60Hz.
Dimming: 1-10V.

Surface and built-in fitting.

Personalization options available

- Configuration layout at vibia.com
- LED 3000 K / 4000 K.
- Dimming: DALI or Casambi.

Min. quantity, upcharge and extra lead time apply.

Materials

Stick: Polyamide 6 with 10% of Fiberglass.
 Diffuser: Polycarbonate.
 Canopy: Steel.

Packaging

2 Boxes.
 Total Vol. 0,6600 m³.
 Gross weight 16,9 Kg.
 Net weight 13 Kg.

2143 14 /13 Chocolate (RAL 8019)
2143 58 /13 Off-white (RAL D2 1109005)
2191-14 Built-in accessory (96mm) chocolate
2191-58 Built-in accessory (96mm) off-white

EAC LED IP20 CE Bi-volt  ø 18,5 cm 
 Only for built-in.

2151

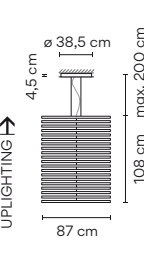

Light Source

20 x LED STRIP 30V 5,8W.
Led 2700 K. CRI >80. 13840 lm. 119 lm/W.
Driver Constant Voltage 30V.
 100-240V. 50/60Hz.
Dimming: 1-10V.

Surface and built-in fitting.

Personalization options available

- Configuration layout at vibia.com
- LED 3000 K / 4000 K.
- Dimming: DALI or Casambi.

Min. quantity, upcharge and extra lead time apply.



Materials

Stick: Polyamide 6 with 10% of Fiberglass.
 Diffuser: Polycarbonate.
 Canopy: Steel.

Packaging

2 Boxes.
 Total Vol. 0,6360 m³.
 Gross weight 14,8 Kg.
 Net weight 7,8 Kg.

2151 14 /13 Chocolate (RAL 8019)
2151 58 /13 Off-white (RAL D2 1109005)
2191-14 Built-in accessory (96mm) chocolate
2191-58 Built-in accessory (96mm) off-white

EAC LED IP20 CE Bi-volt  ø 18,5 cm 
 Only for built-in.

Rhythm Vertical

2152

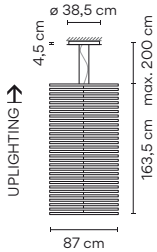

Light Source

30 x LED STRIP 30V 5,8W.
Led 2700 K. CRI >80. 20760 lm. 119 lm/W.
Driver Constant Voltage 30V.
 100-240V. 50/60Hz.
Dimming: 1-10V.

Surface and built-in fitting.

Personalization options available

- Configuration layout at vibia.com
 - LED 3000 K / 4000 K.
 Min. quantity, upcharge and extra lead time apply.

Materials

Stick: Polyamide 6 with 10% of Fiberglass.
 Diffuser: Polycarbonate.
 Canopy: Steel.

Packaging

2 Boxes.
 Total Vol. 0,6950 m³.
 Gross weight 24 Kg.
 Net weight 21,5 Kg.

2152 14 /13 Chocolate
 (RAL 8019)

2152 58 /13 Off-white
 (RAL D2 1109005)

2191-14 Built-in accessory
 (96mm) chocolate

2191-58 Built-in accessory
 (96mm) off-white

EAC LED IP20 CE Bi-volt \varnothing 18,5 cm Δ
 Only for built-in.

2170

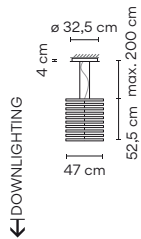

Light Source

10 x LED STRIP 30V 2,9W.
Led 2700 K. CRI >80. 3460 lm. 119 lm/W.
Driver Constant Voltage 30V.
 100-240V. 50/60Hz.
Dimming: 1-10V.

Surface and built-in fitting.

Personalization options available

- Configuration layout at vibia.com
 - LED 3000 K / 4000 K.
 - Dimming: DALI or Casambi.
 Min. quantity, upcharge and extra lead time apply.

Materials

Stick: Polyamide 6 with 10% of Fiberglass.
 Diffuser: Polycarbonate.
 Canopy: Steel.

Packaging

2 Boxes.
 Total Vol. 0,5500 m³.
 Gross weight 7,7 Kg.
 Net weight 5,4 Kg.

2170 14 /13 Chocolate
 (RAL 8019)

2170 58 /13 Off-white
 (RAL D2 1109005)

2192-14 Built-in accessory
 (96mm) chocolate

2192-58 Built-in accessory
 (96mm) off-white

EAC LED IP20 CE Bi-volt \varnothing 18,5 cm Δ
 Only for built-in.

2175

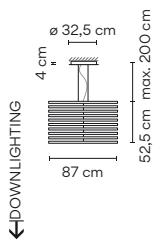

Light Source

10 x LED STRIP 30V 5,8W.
Led 2700 K. CRI >80. 6920 lm. 119 lm/W.
Driver Constant Voltage 30V.
 100-240V. 50/60Hz.
Dimming: 1-10V.

Surface and built-in fitting.

Personalization options available

- Configuration layout at vibia.com
 - LED 3000 K / 4000 K.
 - Dimming: DALI or Casambi.
 Min. quantity, upcharge and extra lead time apply.

Materials

Stick: Polyamide 6 with 10% of Fiberglass.
 Diffuser: Polycarbonate.
 Canopy: Steel.

Packaging

2 Boxes.
 Total Vol. 0,5800 m³.
 Gross weight 9,5 Kg.
 Net weight 7,8 Kg.

2175 14 /13 Chocolate
 (RAL 8019)

2175 58 /13 Off-white
 (RAL D2 1109005)

2192-14 Built-in accessory
 (96mm) chocolate

2192-58 Built-in accessory
 (96mm) off-white

EAC LED IP20 CE Bi-volt \varnothing 18,5 cm Δ
 Only for built-in.

Ameba

Design by Pete Sans

Free form compositions, infinite creations. Ameba's modular hanging lamp is composed of five different components, allowing for bespoke mix and matching.



Create your product configuration quickly and easily at vibia.com

Go to vibia.com and discover the quickest, most effective way to configure a unique Ameba luminaire design.

2200 x 1, 2205 x 1, 2225 x 1

LED version

2202 x 1, 2207 x 1, 2226 x 1



2205 x 2, 2210 x 1, 2225 x 1

LED version

2207 x 2, 2212 x 1, 2226 x 1



2200 x 2, 2205 x 1, 2210 x 2, 2220 x 1, 2225 x 1

LED version

2202 x 2, 2207 x 1, 2212 x 2, 2222 x 1, 2226 x 1

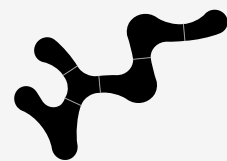

2200 x 3, 2205 x 1, 2210 x 1, 2215 x 3, 2220 x 2, 2225 x 1

LED version

2202 x 3, 2207 x 1, 2212 x 1, 2217 x 3, 2222 x 2, 2226 x 1

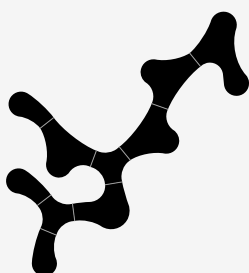

2200 x 3, 2205 x 3, 2210 x 4, 2215 x 4, 2220 x 4, 2225 x 1

LED version

2202 x 3, 2207 x 3, 2212 x 4, 2217 x 4, 2222 x 4, 2226 x 1

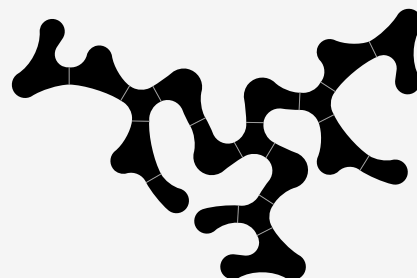

Pendants

2200

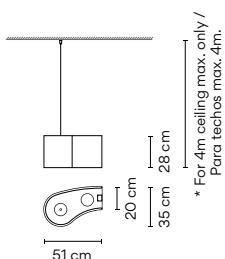

Light Source

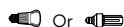

2 x MASTER LEDBulb E27 230V 15W.
Or
2 x COMPACT FLUORESCENT
E27 230V 15W Max.

A maximum of 25 modules can be connected to a single connection point. For bigger compositions, check connection system. For ceiling over 4 metres, ask for custom cable length.

Personalization options available

- Configuration layout at vibia.com
Min. quantity, upcharge and extra lead time apply.

Materials

Body: Polyurethane foam.
Diffuser: Methacrylate.

Packaging

1 Box.
0,42 x 0,71 x 0,66 m.
Vol. 0,1968 m³.
Gross weight 9,2 Kg.
Net weight 5,8 Kg.

2200 03 White
(RAL 9010)

2200 18 Graphite
(RAL 7016)



2202

New

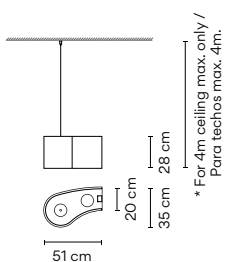

Light Source



2 x LED 9,2W 500mA.
LED 3000 K. CRI >90. 1554 lm. 84,45 lm/W.
Driver Constant Current 500mA.
110-240V. 50/60Hz.
Dimming: DALI.

A maximum of 25 modules can be connected to a single connection point. For bigger compositions, check connection system. For ceiling over 4 metres, ask for custom cable length.

Personalization options available

- Configuration layout at vibia.com
Min. quantity, upcharge and extra lead time apply.

Materials

Driver box: Aluminum.
Body: Polyurethane foam.
Diffuser: Methacrylate.

Packaging

1 Box.
0,42x 0,71 x 0,66 m.
Vol. 0,1968 m³.
Gross weight 9,2 Kg.
Net weight 5,8 Kg.

2202 03 /21 White
(RAL 9010)

2202 18 /21 Graphite
(RAL 7016)

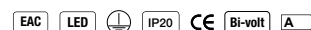

AVAILABLE FROM JUNE

2205

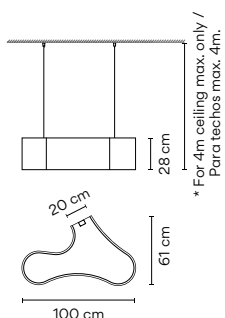

Light Source

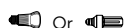

3 x MASTER LEDBulb E27 230V 15W.
Or
3 x COMPACT FLUORESCENT
E27 230V 15W Max.

A maximum of 25 modules can be connected to a single connection point. For bigger compositions, check connection system. For ceiling over 4 metres, ask for custom cable length.

Personalization options available

- Configuration layout at vibia.com
Min. quantity, upcharge and extra lead time apply.

Materials

Body: Polyurethane foam.
Diffuser: Methacrylate.

Packaging

1 Box.
0,45 x 0,95 x 0,95 m.
Vol. 0,4061 m³.
Gross weight 14,4 Kg.
Net weight 12,2 Kg.

2205 03 White
(RAL 9010)

2205 18 Graphite
(RAL 7016)



2207

New

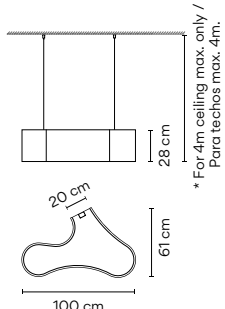

Light Source



4 x LED 9,2W 500mA.
LED 3000 K. CRI >90. 3108 lm. 84,45 lm/W.
Driver Constant Current 500mA.
110-240V. 50/60Hz.
Dimming: DALI.

A maximum of 25 modules can be connected to a single connection point. For bigger compositions, check connection system. For ceiling over 4 metres, ask for custom cable length.

Personalization options available

- Configuration layout at vibia.com
Min. quantity, upcharge and extra lead time apply.

Materials

Body: Polyurethane foam.
Diffuser: Methacrylate.

Packaging

1 Box.
0,45 x 0,95 x 0,95 m.
Vol. 0,4061 m³.
Gross weight 14,4 Kg.
Net weight 12,2 Kg.

2207 03 /21 White
(RAL 9010)

2207 18 /21 Graphite
(RAL 7016)



AVAILABLE FROM JUNE

2210

Light Source
 Or
 3 x MASTER LEDBulb E27 230V 15W.
 Or
 3 x COMPACT FLUORESCENT E27 230V 15W Max.

A maximum of 25 modules can be connected to a single connection point. For bigger compositions, check connection system. For ceiling over 4 metres, ask for custom cable length.

Personalization options available
 - Configuration layout at vibia.com
 Min. quantity, upcharge and extra lead time apply.

Materials
 Body: Polyurethane foam.
 Diffuser: Methacrylate.

Packaging
 1 Box.
 0,50 x 0,77 x 0,77 m.
 Vol. 0,2960 m³.
 Gross weight 11,4 Kg.
 Net weight 9 Kg.

2210 03 White (RAL 9010)
2210 18 Graphite (RAL 7016)

EAC IP20 CE

2212 New

Light Source
 3 x LED 9,2W 500mA.
 LED 3000 K. CRI >90. 2331 lm. 84,45 lm/W.
 Driver Constant Current 500mA.
 110-240V. 50/60Hz.
Dimming: DALI.

A maximum of 25 modules can be connected to a single connection point. For bigger compositions, check connection system. For ceiling over 4 metres, ask for custom cable length.

Personalization options available
 - Configuration layout at vibia.com
 Min. quantity, upcharge and extra lead time apply.

Materials
 Driver box: Aluminum.
 Body: Polyurethane foam.
 Diffuser: Methacrylate.

Packaging
 1 Box.
 0,50 x 0,77 x 0,77 m.
 Vol. 0,2960 m³.
 Gross weight 11,4 Kg.
 Net weight 9 Kg.

2212 03 /21 White (RAL 9010)
2212 18 /21 Graphite (RAL 7016)

EAC LED IP20 CE Bi-volt A

AVAILABLE FROM JUNE

2215

Light Source
 Or
 3 x MASTER LEDBulb E27 230V 15W.
 Or
 3 x COMPACT FLUORESCENT E27 230V 15W Max.

A maximum of 25 modules can be connected to a single connection point. For bigger compositions, check connection system. For ceiling over 4 metres, ask for custom cable length.

Personalization options available
 - Configuration layout at vibia.com
 Min. quantity, upcharge and extra lead time apply.

Materials
 Body: Polyurethane foam.
 Diffuser: Methacrylate.

Packaging
 1 Box.
 0,50 x 0,77 x 0,77 m.
 Vol. 0,2960 m³.
 Gross weight 14,6 Kg.
 Net weight 10 Kg.

2215 03 White (RAL 9010)
2215 18 Graphite (RAL 7016)

EAC IP20 CE

2217 New

Light Source
 3 x LED 9,2W 500mA.
 LED 3000 K. CRI >90. 2331 lm. 84,45 lm/W.
 Driver Constant Current 500mA.
 110-240V. 50/60Hz.
Dimming: DALI.

A maximum of 25 modules can be connected to a single connection point. For bigger compositions, check connection system. For ceiling over 4 metres, ask for custom cable length.

Personalization options available
 - Configuration layout at vibia.com
 Min. quantity, upcharge and extra lead time apply.

Materials
 Body: Polyurethane foam.
 Diffuser: Methacrylate.

Packaging
 1 Box.
 0,50 x 0,77 x 0,77 m.
 Vol. 0,2960 m³.
 Gross weight 14,6 Kg.
 Net weight 10 Kg.

2217 03 /21 White (RAL 9010)
2217 18 /21 Graphite (RAL 7016)

EAC LED IP20 CE Bi-volt A

AVAILABLE FROM JUNE

2220

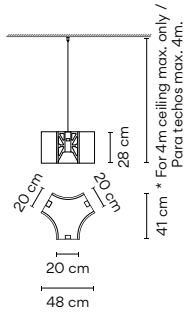

Light Source

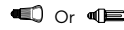

1 x MASTER LEDBulb E27 230V 15W.
Or
1 x COMPACT FLUORESCENT
E27 230V 15W Max.

A maximum of 25 modules can be connected to a single connection point. For bigger compositions, check connection system. For ceiling over 4 metres, ask for custom cable length.

Personalization options available

- Configuration layout at vibia.com
Min. quantity, upcharge and extra lead time apply.

Materials

Body: Polyurethane foam.
Diffuser: Methacrylate

Packaging

1 Box.
0,42 x 0,66 x 0,71 m.
Vol. 0,1968 m³.
Gross weight 8 Kg.
Net weight 4,6 Kg.

2220 03 White
(RAL 9010)

2220 18 Graphite
(RAL 7016)



2222

New

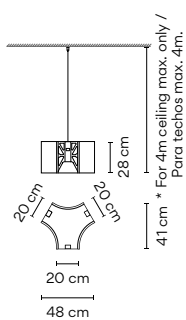

Light Source

1 x LED PLATE 13,5W 700mA.
LED 3000 K. CRI >90. 998 lm. 84,45 lm/W.
Driver Constant Current 700mA.
110-240V. 50/60Hz.
Dimming: DALI.

A maximum of 25 modules can be connected to a single connection point. For bigger compositions, check connection system. For ceiling over 4 metres, ask for custom cable length.

Personalization options available

- Configuration layout at vibia.com
Min. quantity, upcharge and extra lead time apply.

Materials

Driver box: Aluminum
Body: Polyurethane foam.
Diffuser: Methacrylate.

Packaging

1 Box.
0,42 x 0,66 x 0,71 m.
Vol. 0,1968 m³.
Gross weight 8 Kg.
Net weight 4,6 Kg.

2222 03 /21 White
(RAL 9010)

2222 18 /21 Graphite
(RAL 7016)



AVAILABLE FROM JUNE

2225

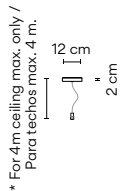

Chrome canopy.

Personalization options available

- Configuration layout at vibia.com
Min. quantity, upcharge and extra lead time apply.

Materials

Canopy Plate: Steel.

Packaging

1 Box.
0,20 x 0,20 x 0,20 m.
Vol. 0,0080 m³.
Gross weight 1,2 Kg.
Net weight 0,8 Kg.

2225 01 Chrome
(Chromeplated)



2226

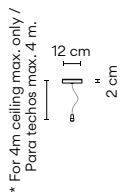

Chrome canopy.

Dimming: DALI System.

Personalization options available

- Configuration layout at vibia.com
Min. quantity, upcharge and extra lead time apply.

Materials

Canopy Plate: Steel.

Packaging

1 Box.
0,20 x 0,20 x 0,20 m.
Vol. 0,0080 m³.
Gross weight 1,2 Kg.
Net weight 0,8 Kg.

2226 01 Chrome
(Chromeplated)



Guise

Design by Stefan Diez

Crafted of precision glass and embedded with a row of recessed LEDs, Guise explores the relationship between light and transparency. The light inside the glass appears invisible while the delicately engraved surface radiates an intense glow, the markings beautifully diffusing the light.



Wall

2260

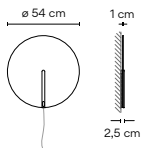

Light Source

1 x LED STRIP 24V 10W.
LED 3000 K. CRI >90. 871,2 lm. 87,12 lm/W.
Driver Constant Voltage 24V.
100-240V. 50/60Hz.
Dimming: Optical Sensor.

Electric cable with plug 3 m.

Personalization options available

- LED 4000 K.
Min. quantity, upcharge and extra lead time apply.

Materials

Diffuser: Borosilicate glass.
LED support: Aluminum.

Packaging

1 Box.
0,69 x 0,69 x 0,09 m.
Vol. 0,043 m³.
Gross weight 7 Kg.
Net weight 4 Kg.

2260 18 /26 Graphite
(ADAPTA RF9913WX)

EAC LED IP20 CE Bi-volt Dimmer A+

2262

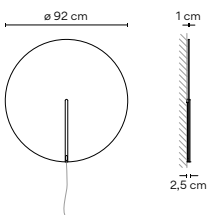

Light Source

1 x LED STRIP 24V 17,2W.
LED 3000 K. CRI >90. 1504,8 lm. 87,12 lm/W.
Driver Constant Voltage 24V.
100-240V. 50/60Hz.
Dimming: Optical Sensor.

Electric cable with plug 3 m.

Personalization options available

- LED 4000 K.
Min. quantity, upcharge and extra lead time apply.

Materials

Diffuser: Borosilicate glass.
LED support: Aluminum.

Packaging

1 Box.
1,04 x 1,04 x 0,10 m.
Vol. 0,104 m³.
Gross weight 16,5 Kg.
Net weight 11,58 Kg.

2262 18 /26 Graphite
(ADAPTA RF9913WX)

EAC LED IP20 CE Bi-volt Dimmer A+

Pendants

2270

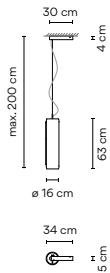

Light Source

1 x LED STRIP 24V 20W.
LED 3000 K. CRI >90. 1742,4 lm. 87,12 lm/W.
Driver Constant Voltage 24V.
110-240V. 50/60Hz.
Dimming: Optical Sensor.

Personalization options available

- LED 4000 K.
 - Dimming: DALI or Casambi.
 - Extra cable length.
- Min. quantity, upcharge and extra lead time apply.

Materials

Diffuser: Borosilicate glass.
Body: Aluminum.

Packaging

1 Box.
0,87 x 0,35 x 0,37 m.
Vol. 0,113 m³.
Gross weight 6,5 Kg.
Net weight 5 Kg.

2270 18 /26 Graphite
(ADAPTA RF9913WX)



2271

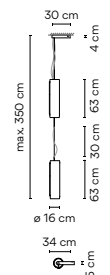

Light Source

2 x LED STRIP 24V 20W.
LED 3000 K. CRI >90. 3484,8 lm. 87,12 lm/W.
Driver Constant Voltage 24V.
110-240V. 50/60Hz.
Dimming: 1-10V.

Personalization options available

- LED 4000 K.
 - Dimming: DALI.
 - Extra cable length.
- Min. quantity, upcharge and extra lead time apply.

Materials

Diffuser: Borosilicate glass.
Body: Aluminum.

Packaging

2 Boxes.
Total Vol. 0,231 m³.
Gross weight 13 Kg.
Net weight 10 Kg.

2271 18 /23 Graphite
(ADAPTA RF9913WX)



2272

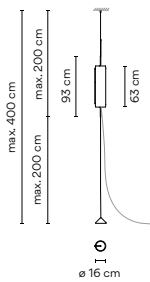

Light Source

1 x LED STRIP 24V 20W.
LED 3000 K. CRI >90. 1742,4 lm. 87,12 lm/W.
Driver Constant Voltage 24V.
100-240V. 50/60Hz.
Dimming: Optical Sensor.

Electric cable with plug 2 m.

Personalization options available

- LED 4000 K.
 - Extra cable length.
- Min. quantity, upcharge and extra lead time apply.

Materials

Diffuser: Borosilicate glass.
Body: Aluminum.

Packaging

1 Box.
1,18 x 0,35 x 0,37 m.
Vol. 0,153 m³.
Gross weight 7 Kg.
Net weight 5 Kg.

2272 18 /26 Graphite
(ADAPTA RF9913WX)



2275

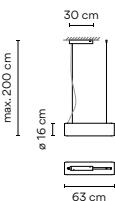

Light Source

1 x LED STRIP 24V 30W.
LED 3000 K. CRI >90. 1742,4 lm. 87,12 lm/W.
Driver Constant Voltage 24V.
110-240V. 50/60Hz.
Dimming: Optical Sensor.

Personalization options available

- LED 4000 K.
 - Dimming: DALI or Casambi.
 - Extra cable length.
- Min. quantity, upcharge and extra lead time apply.

Materials

Diffuser: Borosilicate glass.
Body: Aluminum.

Packaging

1 Box.
0,87 x 0,35 x 0,37 m.
Vol. 0,113 m³.
Gross weight 6,5 Kg.
Net weight 5 Kg.

2275 18 /26 Graphite
(ADAPTA RF9913WX)



2277

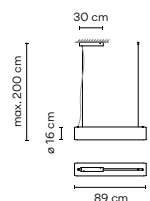

Light Source

1 x LED STRIP 24V 30W.
LED 3000 K. CRI >90. 2613,6 lm. 87,12 lm/W.
Driver Constant Voltage 24V.
100-240V. 50/60Hz.
Dimming: Optical Sensor.

Personalization options available

- LED 4000 K.
 - Dimming: DALI or Casambi.
 - Extra cable length.
- Min. quantity, upcharge and extra lead time apply.

Materials

Diffuser: Borosilicate glass.
Body: Aluminum.

Packaging

1 Box.
1,18 x 0,35 x 0,37 m.
Vol. 0,153 m³.
Gross weight 9,5 Kg.
Net weight 7,5 Kg.

2277 18 /26 Graphite
(ADAPTA RF9913WX)



2282

New

Light Source

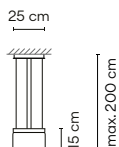

1 x LED STRIP 24V 12W.
LED 3000 K. CRI >90. 1069 lm. 118 lm/W.
Driver Constant Voltage 24V.
 110-240V. 50/60Hz.
 / **2B**: Dimming: 1-10V, Push.
 / **26**: Dimming: Dimmer sensor
 on the LED support.

Personalization options available

- LED 4000 K.
 - Dimming: DALI or Casambi.
 - Extra cable length.
- Min. quantity, upcharge and extra lead time apply.

Materials

Diffuser: Borosilicate glass.
 Body: Aluminum.
 Ceiling rose: Steel.

Packaging

1 Box.
 0,41 x 0,41 x 0,38 m.
 Vol. 0,0639 m³.
 Gross weight 3,3 Kg.
 Net weight 2,3 Kg.

2282 18 /2B Graphite
 (ADAPTA RF9913WX)

2282 18 /26 Graphite
 (ADAPTA RF9913WX)

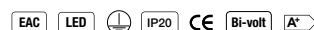

AVAILABLE FROM JULY

2284

New

Light Source

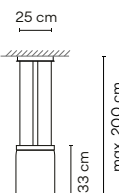

1 x LED STRIP 24V 12W.
LED 3000 K. CRI >90. 1069 lm. 118 lm/W.
Driver Constant Voltage 24V.
 110-240V. 50/60Hz.
 / **2B**: Dimming: 1-10V, Push.
 / **26**: Dimming: Dimmer sensor
 on the LED support.

Personalization options available

- LED 4000 K.
 - Dimming: DALI or Casambi.
 - Extra cable length.
- Min. quantity, upcharge and extra lead time apply.

Materials

Diffuser: Borosilicate glass.
 Body: Aluminum.
 Ceiling rose: Steel.

Packaging

1 Box.
 0,41 x 0,41 x 0,56 m.
 Vol. 0,0941 m³.
 Gross weight 6,2 Kg.
 Net weight 5,2 Kg.

2284 18 /2B Graphite
 (ADAPTA RF9913WX)

2284 18 /26 Graphite
 (ADAPTA RF9913WX)

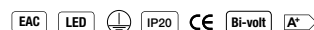

AVAILABLE FROM JULY

2288

New

Light Source

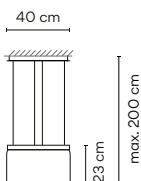

1 x LED STRIP 24V 18W.
LED 3000 K. CRI >90. 1325 lm. 118 lm/W.
Driver Constant Voltage 24V.
 220-240V. 50/60Hz.
 / **2B**: Dimming: 1-10V, Push.
 / **26**: Dimming: Dimmer sensor
 on the LED support.

Personalization options available

- LED 4000 K.
 - Dimming: DALI or Casambi.
 - Extra cable length.
- Min. quantity, upcharge and extra lead time apply.

Materials

Diffuser: Borosilicate glass.
 Body: Aluminum.
 Ceiling rose: Steel.

Packaging

1 Box.
 0,56 x 0,56 x 0,46 m.
 Vol. 0,1443 m³.
 Gross weight 11,7 Kg.
 Net weight 9,7 Kg.

2288 18 /2B Graphite
 (ADAPTA RF9913WX)

2288 18 /26 Graphite
 (ADAPTA RF9913WX)



AVAILABLE FROM JULY

Ceiling

2292

New

Light Source

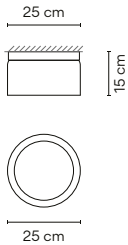

1 x LED STRIP 24V 12W.
LED 3000 K. CRI >90. 1069 lm. 118 lm/W.
Driver Constant Voltage 24V.
110-240V. 50/60Hz.
Dimming: 1-10V, Push.

Personalization options available

- LED 4000 K.
- Dimming: DALI, Casambi.
Min. quantity, upcharge and extra lead time apply.

Materials

Diffuser: Borosilicate glass.
Body: Aluminum.

Packaging

1 Box.
0,41 x 0,41 x 0,33 m.
Vol. 0,0555 m³.
Gross weight 3,2 Kg.
Net weight 2,2 Kg.

2292 18 /2B Graphite
(ADAPTA RF9913WX)



AVAILABLE FROM JULY

2294

New

Light Source

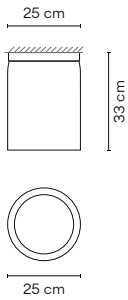

1 x LED STRIP 24V 12W.
LED 3000 K. CRI >90. 1069 lm. 118 lm/W.
Driver Constant Voltage 24V.
110-240V. 50/60Hz.
Dimming: 1-10V, Push.

Personalization options available

- LED 4000 K.
- Dimming: DALI, Casambi.
Min. quantity, upcharge and extra lead time apply.

Materials

Diffuser: Borosilicate glass.
Body: Aluminum.

Packaging

1 Box.
0,41 x 0,41 x 0,51 m.
Vol. 0,0857 m³.
Gross weight 6,1 Kg.
Net weight 5,1 Kg.

2294 18 /2B Graphite
(ADAPTA RF9913WX)

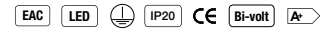

AVAILABLE FROM JULY

2298

New

Light Source

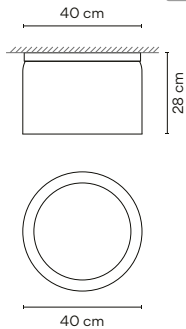

1 x LED STRIP 24V 18W.
LED 3000 K. CRI >90. 1325 lm. 118 lm/W.
Driver Constant Voltage 24V.
220-240V. 50/60Hz.
Dimming: 1-10V, Push.

Personalization options available

- LED 4000 K.
- Dimming: DALI, Casambi.
Min. quantity, upcharge and extra lead time apply.

Materials

Diffuser: Borosilicate glass.
Body: Aluminum.

Packaging

1 Box.
0,56 x 0,56 x 0,46 m.
Vol. 0,1443 m³.
Gross weight 13,3 Kg.
Net weight 11,3 Kg.

2298 18 /2B Graphite
(ADAPTA RF9913WX)



AVAILABLE FROM JULY

Halo Circular

Design by Martín Azúa

A seamless merging of light and matter, Halo lends the effect of light floating in air. Powered by LED bulbs that remain invisible within their opalized, spherical moulds, the light flows freely from its source.



Create your product configuration quickly and easily at vibia.com

Go to vibia.com and discover the quickest, most effective way to configure a unique Halo luminaire design.

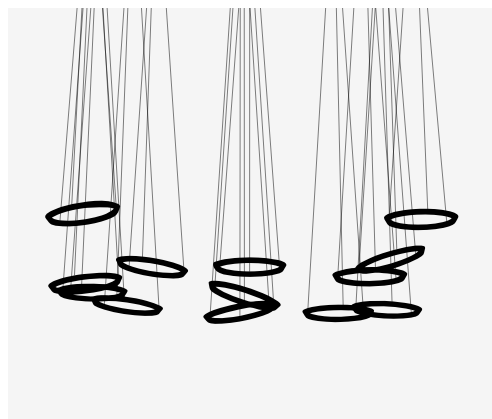
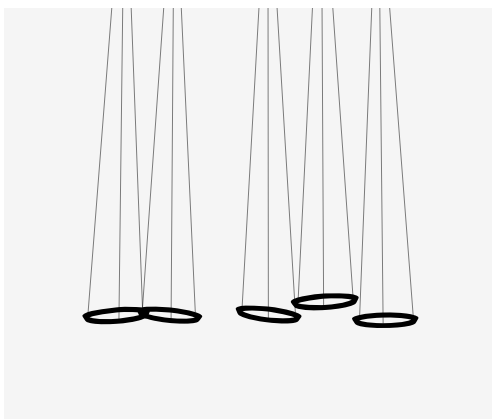
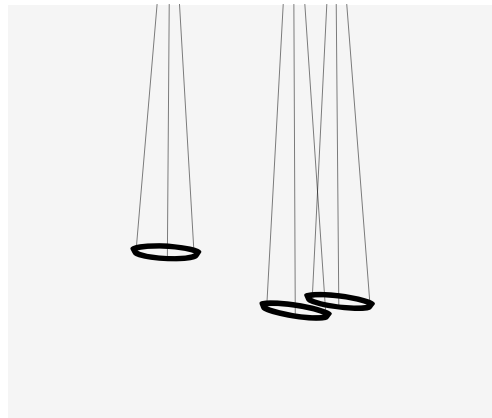
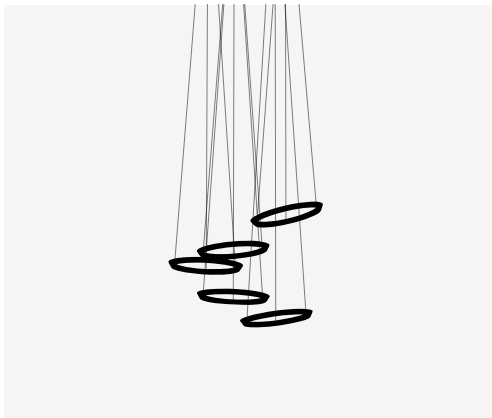

Halo Circular

Pendants

2330

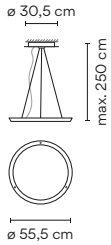

Light Source

1 x LED STRIP 24V 23W.
Led 3000 K. CRI >80.
 2086 lm. 90,7 lm/W.
Driver Constant Voltage 24V.
 100-277V. 50/60Hz.
Dimming: 1-10V.

Personalization options available

- Configuration layout at vibia.com
 - Dimming: DALI or Casambi.
 Min. quantity, upcharge and extra lead time apply.

Materials

Diffuser: PMMA.
 Canopy: Steel.

Packaging

1 Box.
 0,12 x 0,65 x 0,65 m.
 Vol. 0,0507 m³.
 Gross weight 5,75 Kg.
 Net weight 3,75 Kg.

2330 03 White
 (RAL 9016)



2331

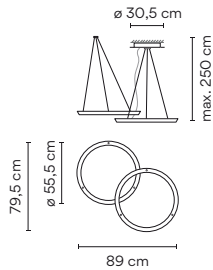

Light Source

2 x LED STRIP 24V 23W.
Led 3000 K. CRI >80.
 4172 lm. 90,7 lm/W.
Driver Constant Voltage 24V.
 100-277V. 50/60Hz.
Dimming: 1-10V.

Personalization options available

- Configuration layout at vibia.com
 - Dimming: DALI or Casambi.
 Min. quantity, upcharge and extra lead time apply.

Materials

Diffuser: PMMA.
 Canopy: Steel.

Packaging

1 Box.
 0,24 x 0,65 x 0,65 m.
 Vol. 0,1014 m³.
 Gross weight 10,25 Kg.
 Net weight 6,25 Kg.

2331 03 White
 (RAL 9016)



2332

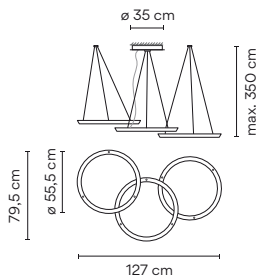

Light Source

3 x LED STRIP 24V 23W.
Led 3000 K. CRI >80.
 6258 lm. 90,7 lm/W.
Driver Constant Voltage 24V.
 100-277V. 50/60Hz.
Dimming: 1-10V.

Personalization options available

- Configuration layout at vibia.com
 - Dimming: DALI or Casambi.
 Min. quantity, upcharge and extra lead time apply.

Materials

Diffuser: PMMA.
 Canopy: Steel.

Packaging

1 Box.
 0,36 x 0,65 x 0,65 m.
 Vol. 0,1521 m³.
 Gross weight 14,75 Kg.
 Net weight 8,75 Kg.

2332 03 White
 (RAL 9016)



2333

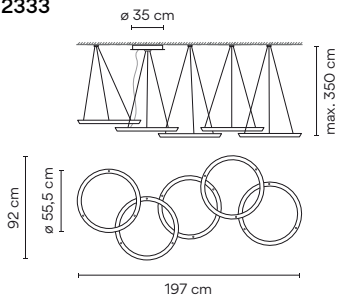

Light Source

5 x LED STRIP 24V 23W.
Led 3000 K. CRI >80.
 10430 lm. 90,7 lm/W.
Driver Constant Voltage 24V.
 100-277V. 50/60Hz.
Dimming: 1-10V.

Personalization options available

- Configuration layout at vibia.com
 - Dimming: DALI or Casambi.
 Min. quantity, upcharge and extra lead time apply.

Materials

Diffuser: PMMA.
 Canopy: Steel.

Packaging

1 Box.
 0,60 x 0,65 x 0,65 m.
 Vol. 0,2535 m³.
 Gross weight 23,75 Kg.
 Net weight 13,75 Kg.

2333 03 White
 (RAL 9016)

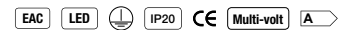

Halo Lineal

Design by Martín Azúa

A seamless merging of light and matter, Halo lends the effect of light floating in air. Powered by LED bulbs that remain invisible within their opalized, linear moulds, the light flows freely from its source.



Create your product configuration quickly and easily at vibia.com

Go to vibia.com and discover the quickest, most effective way to configure a unique Halo luminaire design.

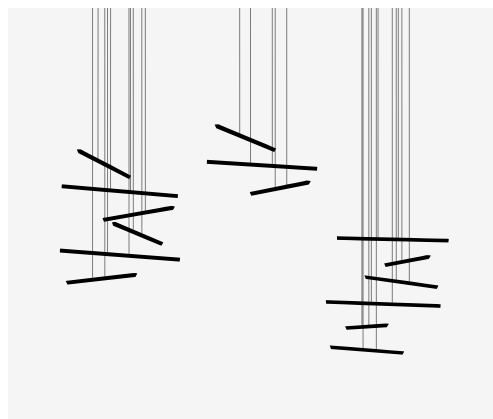
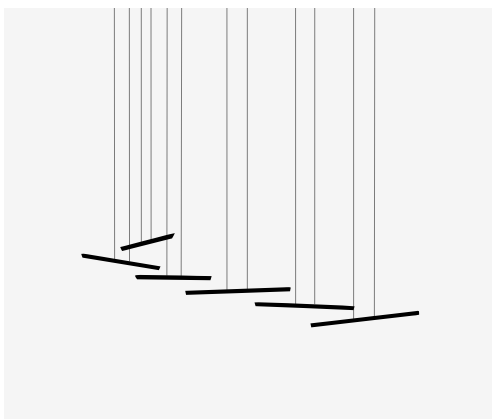
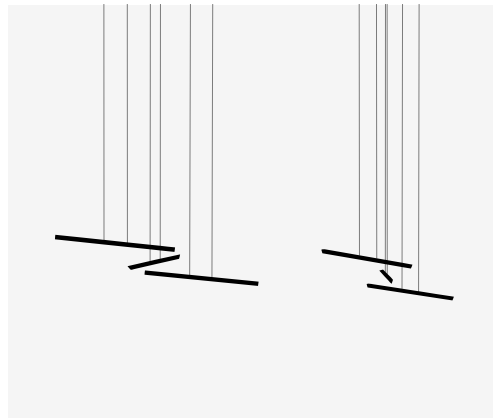
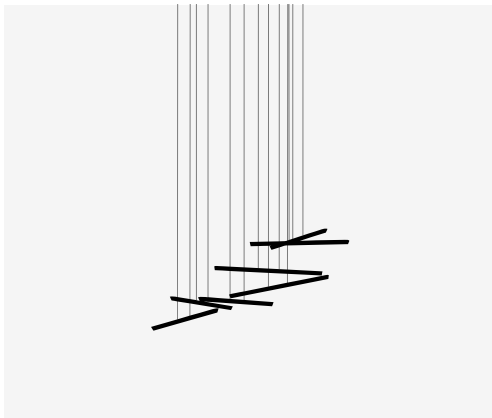

Halo Lineal

Pendants

2340

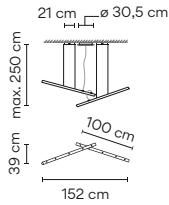

Light Source

2 x LED STRIP 24V 15,3W.
Led 3000 K. CRI >80.
 2567 lm. 83,9 lm/W.
Driver Constant Voltage 24V.
 100-277V. 50/60Hz.
Dimming: 1-10V.

Personalization options available

- Configuration layout at vibia.com
 - Dimming: DALI or Casambi.
 Min. quantity, upcharge and extra lead time apply.

Materials

Diffuser: PMMA.
 Canopy: Steel.

Packaging

1 Box.
 0,20 x 0,24 x 1,10 m.
 Vol. 0,0528 m³.
 Gross weight 6,25 Kg.
 Net weight 3,75 Kg.

2340 03 White
 (RAL 9016)



2341

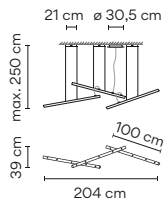

Light Source

3 x LED STRIP 24V 15,3W.
Led 3000 K. CRI >80.
 3851 lm. 90,7 lm/W.
Driver Constant Voltage 24V.
 100-277V. 50/60Hz.
Dimming: 1-10V.

Personalization options available

- Configuration layout at vibia.com
 - Dimming: DALI or Casambi.
 Min. quantity, upcharge and extra lead time apply.

Materials

Diffuser: PMMA.
 Canopy: Steel.

Packaging

1 Box.
 0,20 x 0,24 x 1,10 m.
 Vol. 0,0528 m³.
 Gross weight 8,25 Kg.
 Net weight 5,75 Kg.

2341 03 White
 (RAL 9016)



2342

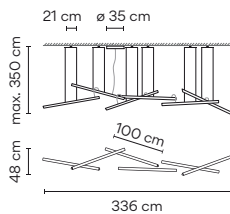

Light Source

6 x LED STRIP 24V 15,3W.
Led 3000 K. CRI >80.
 7702 lm. 90,7 lm/W.
Driver Constant Voltage 24V.
 100-277V. 50/60Hz.
Dimming: 1-10V.

Personalization options available

- Configuration layout at vibia.com
 - Dimming: DALI or Casambi.
 Min. quantity, upcharge and extra lead time apply.

Materials

Diffuser: PMMA.
 Canopy: Steel.

Packaging

1 Box.
 0,20 x 0,24 x 1,10 m.
 Vol. 0,1267 m³.
 Gross weight 11,8 Kg.
 Net weight 10,25 Kg.

2342 03 White
 (RAL 9016)

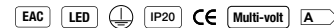

2343

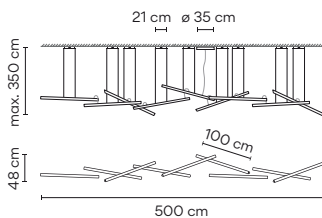

Light Source

9 x LED STRIP 24V 15,3W.
Led 3000 K. CRI >80.
 11552 lm. 90,7 lm/W.
Driver Constant Voltage 24V.
 100-277V. 50/60Hz.
Dimming: 1-10V.

Personalization options available

- Configuration layout at vibia.com
 - Dimming: DALI or Casambi.
 Min. quantity, upcharge and extra lead time apply.

Materials

Diffuser: PMMA.
 Canopy: Steel.

Packaging

1 Box.
 0,22 x 0,48 x 1,20 m.
 Vol. 0,1267 m³.
 Gross weight 16,20 Kg.
 Net weight 14,75 Kg.

2343 03 White
 (RAL 9016)

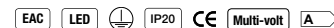

Halo Jewel

Design by Martín Azúa

Subtle light floating in the air and delicately suspended by a perfectly crafted steel structure. Light and matter in one.

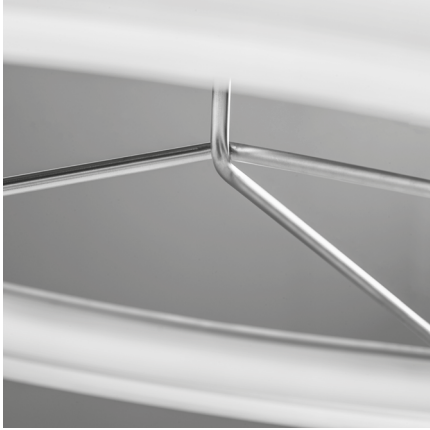

Pendants

2350

New

Light Source

1 x LED STRIP 24V 23W.
LED 3000 K. CRI >80. 2024 lm. 98,8 lm/W.
Driver Constant Voltage 24V.
100-277V. 50/60Hz.
Dimming: 1-10V.

Personalization options available
- Dimming: DALI or Casambi.
Min. quantity, upcharge and extra lead time apply.

Materials

Diffuser: Methacrylate.
LED support: Aluminum.
Pendant structure: Steel.
Ceiling rose: Steel.

Packaging

1 Box.
0,76 x 0,76 x 0,27 m.
Vol. 0,156 m³.
Gross weight 7 Kg.
Net weight 6,35 Kg.

2350 11 /23 Black
(NCS S 8500-N)

2350 20 /23 Gold
(Gold)

EAC LED IP20 CE Multi-volt A+

AVAILABLE FROM JUNE

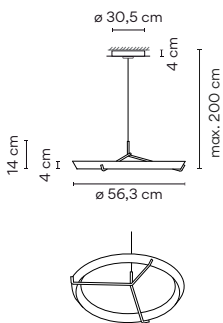

2351

New

Light Source

1 x LED STRIP 24V 23W.
LED 3000 K. CRI >80. 2024 lm. 98,8 lm/W.
Driver Constant Voltage 24V.
100-277V. 50/60Hz.
Dimming: 1-10V.

Personalization options available
- Dimming: DALI or Casambi.
Min. quantity, upcharge and extra lead time apply.

Materials

Diffuser: Methacrylate.
LED support: Aluminum.
Pendant structure: Steel.
Ceiling rose: Steel.

Packaging

1 Box.
0,76 x 0,76 x 0,27 m.
Vol. 0,156 m³.
Gross weight 7 Kg.
Net weight 6,35 Kg.

2351 11 /23 Black
(NCS S 8500-N)

2351 20 /23 Gold
(Gold)

EAC LED IP20 CE Multi-volt A+

AVAILABLE FROM JUNE

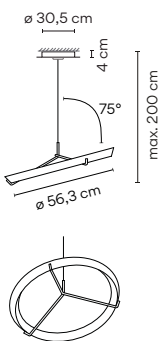

Halo Jewel

2355

∅ 20 cm

New

Light Source

1 x LED STRIP 24V 15,3W.
LED 3000 K. CRI >80. 1224 lm. 98,8 lm/W.
Driver Constant Voltage 24V.
220-240V. 50/60Hz.
Dimming: 1-10V.

Personalization options available
- Dimming: DALI or Casambi.
Min. quantity, upcharge and extra lead time apply.

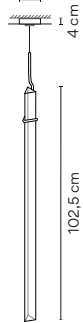

Materials

Diffuser: Methacrylate.
LED support: Aluminum.
Pendant structure: Steel.
Ceiling rose: Steel.

Packaging

2 Boxes.
Total Vol. 0,055 m³.
Gross weight 5 Kg.
Net weight 4,1 Kg.

2355 11 /23 Black
(NCS S 8500-N)

2355 20 /23 Gold
(Gold)



AVAILABLE FROM JUNE

2356

∅ 30,5 cm

New

Light Source

3 x LED STRIP 24V 15,3W.
LED 3000 K. CRI >80. 3672 lm. 98,8 lm/W.
Driver Constant Voltage 24V.
100-277V. 50/60Hz.
Dimming: 1-10V.

Personalization options available
- Dimming: DALI or Casambi.
Min. quantity, upcharge and extra lead time apply.

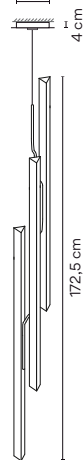

Materials

Diffuser: Methacrylate.
LED support: Aluminum.
Pendant structure: Steel.
Ceiling rose: Steel.

Packaging

2 Boxes.
Total Vol. 0,094 m³.
Gross weight 7,4 Kg.
Net weight 6,06 Kg.

2356 11 /23 Black
(NCS S 8500-N)

2356 20 /23 Gold
(Gold)



AVAILABLE FROM JUNE

Halo Wall

Design by Martín Azúa

A seamless merging of light and matter, Halo Wall lends the effect of light floating in the air and bathing the walls. A feature piece which creates subtle, magical light.



Wall

2360

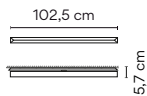

New

Light Source

1 x LED STRIP 24V 15,3W.
Led 3000 K. CRI >80. 1224 lm. 80 lm/W.
Driver Constant Voltage 24V.
 220-240V. 50/60Hz.
Dimming: 1-10V.

Personalization options available

- Dimming: DALI or Casambi.
 Min. quantity, upcharge and extra lead time apply.

Materials

Diffuser: Methacrylate.
 LED support: Aluminum.

Packaging

1 Box.
 0,10 x 1,025 x 0,10 m.
 Vol. 0,01 m³.
 Gross weight 2,25 Kg.
 Net weight 1,75 Kg.

2360 11 /23 Black
 (NCS S 8500-N)

2360 13 /23 Grey L1
 (NCS S 1000-N)



AVAILABLE FROM JUNE

2361

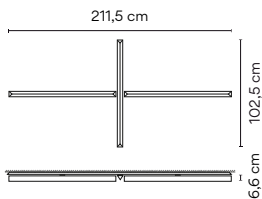

New

Light Source

3 x LED STRIP 24V 15,3W.
Led 3000 K. CRI >80. 3672 lm. 80 lm/W.
Driver Constant Voltage 24V.
 220-240V. 50/60Hz.
Dimming: 1-10V.

The rotation around a central axis allows for movement of the light sticks in the desired position: perpendicular, vertical, diagonal and progressive, creating wall arts in the space.

Personalization options available

- Dimming: DALI or Casambi.
 Min. quantity, upcharge and extra lead time apply.

Materials

Diffuser: Methacrylate.
 LED support: Aluminum.

Packaging

1 Box.
 0,15 x 2,20 x 0,15 m.
 Vol. 0,05 m³.
 Gross weight 5,5 Kg.
 Net weight 4,5 Kg.

2361 11 /23 Black
 (NCS S 8500-N)

2361 13 /23 Grey L1
 (NCS S 1000-N)



AVAILABLE FROM JUNE

2362

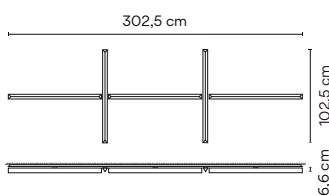

New

Light Source

5 x LED STRIP 24V 15,3W.
Led 3000 K. CRI >80. 6120 lm. 80 lm/W.
Driver Constant Voltage 24V.
 220-240V. 50/60Hz.
Dimming: 1-10V.

The rotation around a central axis allows for movement of the light sticks in the desired position: perpendicular, vertical, diagonal and progressive, creating wall arts in the space.

Personalization options available

- Dimming: DALI or Casambi.
 Min. quantity, upcharge and extra lead time apply.

Materials

Diffuser: Methacrylate.
 LED support: Aluminum.

Packaging

1 Box.
 0,15 x 3,40 x 0,15 m.
 Vol. 0,077 m³.
 Gross weight 9,5 Kg.
 Net weight 7,5 Kg.

2362 11 /23 Black
 (NCS S 8500-N)

2362 13 /23 Grey L1
 (NCS S 1000-N)



AVAILABLE FROM JUNE

Cosmos

Design by Lievore, Altherr, Molina

Design and light become one with Cosmos pendant. Flattened spheres in suspension that naturally descend from the ceiling and use light to draw a fluctuating course like a constellation of stars.



Pendants

2500

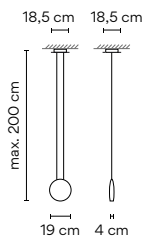

Light Source

1 x LED 4,5W 350mA.
LED 2700 K. CRI >80. 490 lm. 109 lm/W.
Driver Constant Current 350mA. 50/60Hz.
/ 10: Dimmable: No. 100-240V.
/ 1B: Dimmable: 1-10V, Push. 110-240V.

Personalization options available

- LED 3000 K / 4000 K.
- Dimming: DALI or Casambi.
- Extra cable length.

Min. quantity, upcharge and extra lead time apply.

Materials

Diffuser: Polycarbonate.
 Body: ABS.
 Canopy Plate: Steel.

Packaging

1 Box.
 0,26 x 0,26 x 0,26 m.
 Vol. 0,0180 m³.
 Gross weight 1,62 Kg.
 Net weight 1,18 Kg.

2500 14 /10 Chocolate
 (RAL 8019)

2500 14 /1B Chocolate
 (RAL 8019)

2500 62 /10 Green
 (PANTONE 5645)

2500 62 /1B Green
 (PANTONE 5645)

2500 66 /10 Light-grey
 (PANTONE 403)

2500 66 /1B Light-grey
 (PANTONE 403)



2501

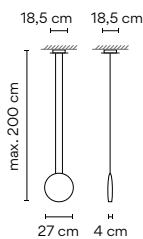

Light Source

1 x LED 4,5W 350mA.
LED 2700 K. CRI >80. 490 lm. 109 lm/W.
Driver Constant Current 350mA. 50/60Hz.
Dimming: 1-10V, Push.
/ 10: Dimmable: No. 100-240V.
/ 1B: Dimmable: 1-10V, Push. 110-240V.

Personalization options available

- LED 3000 K / 4000 K.
- Dimming: DALI or Casambi.
- Extra cable length.

Min. quantity, upcharge and extra lead time apply.

Materials

Diffuser: Polycarbonate.
 Body: ABS.
 Canopy Plate: Steel.

Packaging

1 Box.
 0,42 x 0,42 x 0,25 m.
 Vol. 0,0441 m³.
 Gross weight 2,54 Kg.
 Net weight 1,44 Kg.

2501 14 /10 Chocolate
 (RAL 8019)

2501 14 /1B Chocolate
 (RAL 8019)

2501 62 /10 Green
 (PANTONE 5645)

2501 62 /1B Green
 (PANTONE 5645)

2501 66 /10 Light-grey
 (PANTONE 403)

2501 66 /1B Light-grey
 (PANTONE 403)



2502

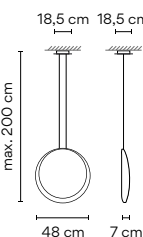

Light Source

1 x LED 4,5W 350mA.
 1 x LED 1W 350mA.
LED 2700 K. CRI >80. 612 lm. 110 lm/W.
Driver Constant Current 350mA.
 110-240V. 50/60Hz.
Dimming: 1-10V, Push.

Personalization options available

- Dimming: DALI or Casambi.
- Extra cable length.

Min. quantity, upcharge and extra lead time apply.

Materials

Diffuser: Polycarbonate.
 Body: Polyurethane.
 Canopy Plate: Steel.

Packaging

1 Box.
 0,60 x 0,60 x 0,27 m.
 Vol. 0,0970 m³.
 Gross weight 5,58 Kg.
 Net weight 3,15 Kg.

2502 03 /1B White
 (RAL 9010)



2510

Light Source
 3 x LED 4,5W 350mA.
Led 2700 K. CRI >80. 1471 lm. 109 lm/W.
Driver Constant Current 350mA.
 110-240V. 50/60Hz.
Dimming: DALI, 1-10V, Push.

Compositions and finishes can not be changed.

Personalization options available
 - LED 3000 K / 4000 K.
 - Dimming: DALI, 1-10V, Push.
 - Extra cable length.
 Min. quantity, upcharge and extra lead time apply.

Materials
 Diffuser: Polycarbonate.
 Body: ABS.
 Canopy Plate: Steel.

Packaging
 1 Box.
 0,60 x 0,60 x 0,27 m.
 Vol. 0,0970 m³.
 Gross weight 7,54 Kg.
 Net weight 5,11 Kg.

2510 62 /1A Green ,
 Chocolate and Light-grey
 (PANTONE 5645, RAL 8019, PANTONE 403)

EAC LED IP20 CE Bi-volt A+

2511

Light Source
 3 x LED 4,5W 350mA.
 1 x LED 1W 350mA.
Led 2700 K. CRI >80. 1593 lm. 109 lm/W.
Driver Constant Current 350mA.
 110-240V. 50/60Hz.
Dimming: DALI, 1-10V, Push.

Compositions and finishes can not be changed.

Personalization options available
 - Dimming: Casambi.
 - Extra cable length.
 Min. quantity, upcharge and extra lead time apply.

Materials
 Diffuser: Polycarbonate.
 Body: ABS + Polyurethane.
 Canopy Plate: Steel.

Packaging
 1 Box.
 0,60 x 0,60 x 0,27 m.
 Vol. 0,0970 m³.
 Gross weight 9,25 Kg.
 Net weight 6,82 Kg.

2511 62 /1A Green, White
 and Chocolate
 (PANTONE 5645, RAL 9010, RAL 8019)

2511 66 /1A Light-grey, White
 and Chocolate
 (PANTONE 403, RAL 9010, RAL 8019)

EAC LED IP20 CE Bi-volt A+

2515

Light Source
 4 x LED 4,5W 350mA.
Led 2700 K. CRI >80. 1961 lm. 109 lm/W.
Driver Constant Current 350mA.
 110-240V. 50/60Hz.
Dimming: DALI, 1-10V, Push.

Compositions and finishes can not be changed.

Personalization options available
 - LED 3000 K / 4000 K.
 - Dimming: Casambi.
 - Extra cable length.
 Min. quantity, upcharge and extra lead time apply.

Materials
 Diffuser: Polycarbonate.
 Body: ABS.
 Canopy Plate: Steel.

Packaging
 1 Box.
 0,76 x 0,76 x 0,27 m.
 Vol. 0,1560 m³.
 Gross weight 10,94 Kg.
 Net weight 7,04 Kg.

2515 62 /1A Green, Light-grey
 and Chocolate
 (PANTONE 5645, PANTONE 403, RAL 8019)

EAC LED IP20 CE Bi-volt A+

2516

Light Source
 4 x LED 4,5W 350mA.
 2x LED 1W 350mA.
Led 2700 K. CRI >80. 2205 lm. 109 lm/W.
Driver Constant Current 350mA.
 110-240V. 50/60Hz.
Dimming: DALI, 1-10V, Push.

Compositions and finishes can not be changed.

Personalization options available
 - Dimming: Casambi.
 - Extra cable length.
 Min. quantity, upcharge and extra lead time apply.

Materials
 Diffuser: Polycarbonate.
 Body: ABS + Polyurethane.
 Canopy Plate: Steel.

Packaging
 1 Box.
 0,76 x 0,76 x 0,27 m.
 Vol. 0,1560 m³.
 Gross weight 14,62 Kg.
 Net weight 15,5 Kg.

2516 62 /1A Green, White and Chocolate
 (PANTONE 5645, RAL 9010, RAL 8019)

EAC LED IP20 CE Bi-volt A+

Structural

Design by Arik Levy

Structural's cubic forms pair with slender metal rods that both join and separate the volumes, providing points of light connected in space. Its design deconstructs the light source and casts it in unexpected places, creating sculptural pieces integrated in the architecture.



Wall

2600

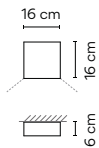

Light Source



1 x LED PLATE 24V 6W.
LED 3000 K. CRI >90. 708 lm. 118 lm/W.
Driver Constant Voltage 24V.
110-240V. 50/60Hz.
Dimming: 1-10V.

Personalization options available

- Finish customization.
(Available options: Vibia color palette).
- LED 4000 K.
- Dimming: DALI or Casambi.
Min. quantity, upcharge and extra lead time apply.

Materials

Diffuser: Polycarbonate.
Main body: Aluminum.
Structures: Aluminum.

Packaging

1 Box.
0,4 x 0,4 x 0,2 m.
Vol. 0,032 m³.
Gross weight 1,35 Kg.
Net weight 0,9 Kg.

2600 21 /23 Grey D1
(NCS S 7000-N)

2600 15 /23 Grey L2
(NCS S 2500-N)



2602

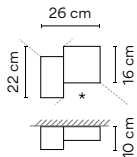

Light Source



2 x LED PLATE 24V 6W.
LED 3000 K. CRI >90. 1416 lm. 118 lm/W.
Driver Constant Voltage 24V.
110-240V. 50/60Hz.
Dimming: 1-10V.

* Electrical connection point.

Personalization options available

- Finish customization.
(Available options: Vibia color palette).
- LED 4000 K.
- Dimming: DALI or Casambi.
Min. quantity, upcharge and extra lead time apply.

Materials

Diffuser: Polycarbonate.
Main body: Aluminum.
Structures: Aluminum.

Packaging

1 Box.
0,4 x 0,4 x 0,2 m.
Vol. 0,032 m³.
Gross weight 2,85 Kg.
Net weight 1,9 Kg.

2602 21 /23 Grey D1
(NCS S 7000-N)

2602 15 /23 Grey L2
(NCS S 2500-N)



2610

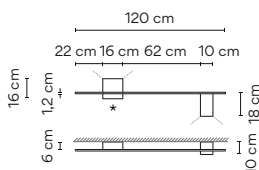

Light Source



2 x LED PLATE 24V 6W.
LED 3000 K. CRI >90. 1416 lm. 118 lm/W.
Driver Constant Voltage 24V.
110-240V. 50/60Hz.
Dimming: 1-10V.

* Electrical connection point.

Personalization options available

- Finish customization.
(Available options: Vibia color palette).
- LED 4000 K.
- Dimming: DALI or Casambi.
Min. quantity, upcharge and extra lead time apply.

Materials

Diffuser: Polycarbonate.
Main body: Aluminum.
Structures: Aluminum.

Packaging

2 Boxes.
Total Vol. 0,036 m³.
Gross weight 3,6 Kg.
Net weight 2,4 Kg.

2610 21 /23 Grey D1
(NCS S 7000-N)

2610 15 /23 Grey L2
(NCS S 2500-N)



2612

Light Source
 2 x LED PLATE 24V 6W.
LED 3000 K. CRI >90. 1416 lm. 118 lm/W.
Driver Constant Voltage 24V.
 110-240V. 50/60HZ.
Dimming: 1-10V.
 * Electrical connection point.

Personalization options available
 - Finish customization.
 (Available options: Vibia color palette).
 - LED 4000 K.
 - Dimming: DALI or Casambi.
 Min. quantity, upcharge and extra lead time apply.

Materials
 Diffuser: Polycarbonate.
 Main body: Aluminum.
 Structures: Aluminum.

Packaging
 2 Boxes.
 Total Vol. 0,042 m³.
 Gross weight 3,9 Kg.
 Net weight 2,6 Kg.

2612 21 /23 Grey D1
 (NCS S 7000-N)

2612 15 /23 Grey L2
 (NCS S 2500-N)

EAC LED IP20 CE Bi-volt

2615

Light Source
 2 x LED PLATE 24V 6W.
LED 3000 K. CRI >90. 1416 lm. 118 lm/W.
Driver Constant Voltage 24V.
 110-240V. 50/60HZ.
Dimming: 1-10V.
 * Electrical connection point.

Personalization options available
 - Finish customization.
 (Available options: Vibia color palette).
 - LED 4000 K.
 - Dimming: DALI or Casambi.
 Min. quantity, upcharge and extra lead time apply.

Materials
 Diffuser: Polycarbonate.
 Main body: Aluminum.
 Structures: Aluminum.

Packaging
 2 Boxes.
 Total Vol. 0,038 m³.
 Gross weight 4,35 Kg.
 Net weight 2,9 Kg.

2615 21 /23 Grey D1
 (NCS S 7000-N)

2615 15 /23 Grey L2
 (NCS S 2500-N)

EAC LED IP20 CE Bi-volt

2617

Light Source
 2 x LED PLATE 24V 6W.
LED 3000 K. CRI >90. 1416 lm. 118 lm/W.
Driver Constant Voltage 24V.
 110-240V. 50/60Hz.
Dimming: 1-10V.
 * Electrical connection point.

Personalization options available
 - Finish customization.
 (Available options: Vibia color palette).
 - LED 4000 K.
 - Dimming: DALI or Casambi.
 Min. quantity, upcharge and extra lead time apply.

Materials
 Diffuser: Polycarbonate.
 Main body: Aluminum.
 Structures: Aluminum.

Packaging
 2 Boxes.
 Total Vol. 0,041 m³.
 Gross weight 4,35 Kg.
 Net weight 2,9 Kg.

2617 21 /23 Grey D1
 (NCS S 7000-N)

2617 15 /23 Grey L2
 (NCS S 2500-N)

EAC LED IP20 CE Bi-volt

2620

Light Source
 2 x LED PLATE 24V 6W.
LED 3000 K. CRI >90. 1416 lm. 118 lm/W.
Driver Constant Voltage 24V.
 110-240V. 50/60Hz.
Dimming: 1-10V.
 * Electrical connection point.

Personalization options available
 - Finish customization.
 (Available options: Vibia color palette).
 - LED 4000 K.
 - Dimming: DALI or Casambi.
 Min. quantity, upcharge and extra lead time apply.

Materials
 Diffuser: Polycarbonate.
 Main body: Aluminum.
 Structures: Aluminum.

Packaging
 2 Boxes.
 Total Vol. 0,0356 m³.
 Gross weight 3,6 Kg.
 Net weight 2,4 Kg.

2620 21 /23 Grey D1
 (NCS S 7000-N)

2620 15 /23 Grey L2
 (NCS S 2500-N)

EAC LED IP20 CE Bi-volt

Structural

Ceiling

2630

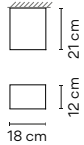

Light Source



1 x LED PLATE 24V 9W.
LED 3000 K. CRI >90. 708 lm. 118 lm/W.
Driver Constant Voltage 24V.
110-240V. 50/60Hz.
Dimming: 1-10V.

Personalization options available

- Finish customization.
(Available options: Vibia color palette).
- LED 4000 K.
- Dimming: DALI or Casambi.
Min. quantity, upcharge and extra lead time apply.

Materials

Diffuser: Polycarbonate.
Main body: Aluminum.
Structures: Aluminum.

Packaging

1 Box.
0,4 x 0,4 x 0,2 m.
Vol. 0,032 m³.
Gross weight 3,75 Kg.
Net weight 2,5 Kg.

2630 21 /23 Grey D1
(NCS S 7000-N)

2630 15 /23 Grey L2
(NCS S 2500-N)



AVAILABLE FROM JULY

2632

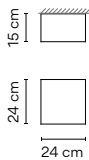

Light Source



1 x LED PLATE 24V 15W.
LED 3000 K. CRI >90. 2006 lm. 118 lm/W.
Driver Constant Voltage 24V.
110-240V. 50/60Hz.
Dimming: 1-10V.

Personalization options available

- Finish customization.
(Available options: Vibia color palette).
- LED 4000 K.
- Dimming: DALI or Casambi.
Min. quantity, upcharge and extra lead time apply.

Materials

Diffuser: Polycarbonate.
Main body: Aluminum.
Structures: Aluminum.

Packaging

1 Box.
0,34 x 0,34 x 0,25 m.
Vol. 0,029 m³.
Gross weight 4,35 Kg.
Net weight 2,9 Kg.

2632 21 /23 Grey D1
(NCS S 7000-N)

2632 15 /23 Grey L2
(NCS S 2500-N)



AVAILABLE FROM JULY

2634

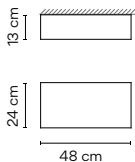

Light Source



1 x LED PLATE 24V 30W.
LED 3000 K. CRI >90. 2006 lm. 118 lm/W.
Driver Constant Voltage 24V.
110-240V. 50/60Hz.
Dimming: 1-10V.

Personalization options available

- Finish customization.
(Available options: Vibia color palette).
- LED 4000 K.
- Dimming: DALI or Casambi.
Min. quantity, upcharge and extra lead time apply.

Materials

Diffuser: Polycarbonate.
Main body: Aluminum.
Structures: Aluminum.

Packaging

1 Box.
0,58 x 0,34 x 0,23 m.
Vol. 0,045 m³.
Gross weight 5,85 Kg.
Net weight 3,9 Kg.

2634 21 /23 Grey D1
(NCS S 7000-N)

2634 15 /23 Grey L2
(NCS S 2500-N)



AVAILABLE FROM JULY

2640

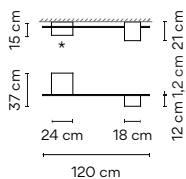

Light Source



1 x LED PLATE 24V 9W.
1 x LED PLATE 24V 15W.
LED 3000 K. CRI >90. 2714 lm. 118 lm/W.
Driver Constant Voltage 24V.
110-240V. 50/60Hz.
Dimming: 1-10V.

* Electrical connection point.

Personalization options available

- Finish customization.
(Available options: Vibia color palette).
- LED 4000 K.
- Dimming: DALI or Casambi.
Min. quantity, upcharge and extra lead time apply.

Materials

Diffuser: Polycarbonate.
Main body: Aluminum.
Structures: Aluminum.

Packaging

1 Box.
0,25 x 0,5 x 1,2 m.
Vol. 0,15 m³.
Gross weight 8,25 Kg.
Net weight 5,5 Kg.

2640 21 /23 Grey D1
(NCS S 7000-N)

2640 15 /23 Grey L2
(NCS S 2500-N)



AVAILABLE FROM JULY

Structural

2642

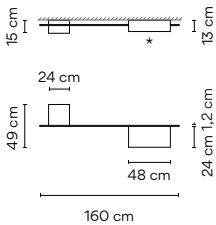

Light Source



1 x LED PLATE 24V 15W.
1 x LED PLATE 24V 30W.
LED 3000 K, CRI >90. 6018 lm. 118 lm/W.
Driver Constant Voltage 24V.
110-240V. 50/60Hz.
Dimming: 1-10V.

* Electrical connection point.

Personalization options available

- Finish customization. (Available options: Vibia color palette).
 - LED 4000 K.
 - Dimming: DALI or Casambi.
- Min. quantity, upcharge and extra lead time apply.

Materials

Diffuser: Polycarbonate.
Main body: Aluminum.
Structures: Aluminum.

Packaging

1 Box.
0,25 x 0,60 x 1,7 m.
Vol. 0,255 m³.
Gross weight 11,25 Kg.
Net weight 7,5 Kg.

2642 21 /23 Grey D1
(NCS S 7000-N)

2642 15 /23 Grey L2
(NCS S 2500-N)



AVAILABLE FROM JULY

2645

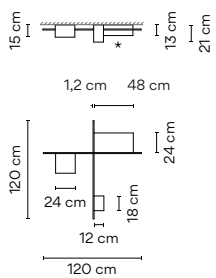

Light Source



1 x LED PLATE 24V 9W.
1 x LED PLATE 24V 15W.
1 x LED PLATE 24V 30W.
LED 3000 K, CRI >90. 6726 lm. 118 lm/W.
Driver Constant Voltage 24V.
110-240V. 50/60Hz.
Dimming: 1-10V.

* Electrical connection point.

Personalization options available

- Finish customization. (Available options: Vibia color palette).
 - LED 4000 K.
 - Dimming: DALI or Casambi.
- Min. quantity, upcharge and extra lead time apply.

Materials

Diffuser: Polycarbonate.
Main body: Aluminum.
Structures: Aluminum.

Packaging

1 Box.
0,25 x 1,2 x 1,2 m.
Vol. 0,42 m³.
Gross weight 14,25 Kg.
Net weight 9,25 Kg.

2645 21 /23 Grey D1
(NCS S 7000-N)

2645 15 /23 Grey L2
(NCS S 2500-N)



AVAILABLE FROM JULY

2647

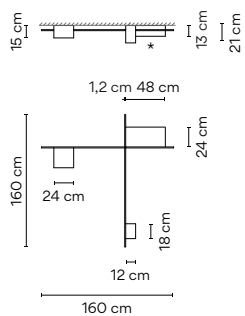

Light Source



1 x LED PLATE 24V 9W.
1 x LED PLATE 24V 15W.
1 x LED PLATE 24V 30W.
LED 3000 K, CRI >90. 6726 lm. 118 lm/W.
Driver Constant Voltage 24V.
110-240V. 50/60Hz.
Dimming: 1-10V.

* Electrical connection point.

Personalization options available

- Finish customization. (Available options: Vibia color palette).
 - LED 4000 K.
 - Dimming: DALI or Casambi.
- Min. quantity, upcharge and extra lead time apply.

Materials

Diffuser: Polycarbonate.
Main body: Aluminum.
Structures: Aluminum.

Packaging

1 Box.
0,25 x 1,7 x 1,7 m.
Vol. 0,72 m³.
Gross weight 15,3 Kg.
Net weight 10,2 Kg.

2647 21 /23 Grey D1
(NCS S 7000-N)

2647 15 /23 Grey L2
(NCS S 2500-N)



AVAILABLE FROM JULY

Palma

Design by Antoni Arola

The interior ambience takes on a life of its own with the possibility of integrating plants with the lighting compositions. Palma connects light and vegetation as in the natural landscape.



Wall

3700

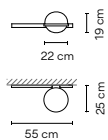

Light Source

2 x LED 4,6W 500mA.
LED 2700 K. CRI >90. 868 lm. 94,34 lm/W.
Driver Constant Current 500mA.
220-240V. 50/60Hz.
Dimming: 1-10V, Push.

Personalization options available
- LED 3000 K / 4000 K.
Min. quantity, upcharge and extra lead time apply.

Materials

Diffuser: Blown-glass.
Profile: Aluminum.

Packaging

1 Box.
0,57 x 0,31 x 0,21 m.
Vol. 0,0382 m³.
Gross weight 3 Kg.
Net weight 1,8 Kg.

3700 18 /1B Graphite
(ADAPTA RF 9913 WX)

3700 93 /1B White
(RAL 9016)



3702

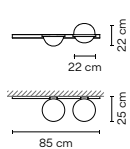

Light Source

2 x LED 4,6W 500mA.
LED 2700 K. CRI >90. 868 lm. 94,34 lm/W.
Driver Constant Current 500mA.
220-240V. 50/60Hz.
Dimming: 1-10V, Push.

Personalization options available
- LED 3000 K / 4000 K.
- Dimming: DALI.
Min. quantity, upcharge and extra lead time apply.

Materials

Diffuser: Blown-glass.
Profile: Aluminum.
Planter: PMMA.

Packaging

1 Box.
0,87 x 0,31 x 0,21 m.
Vol. 0,0581 m³.
Gross weight 4,05 Kg.
Net weight 2,4 Kg.

3702 18 /1B Graphite
(ADAPTA RF 9913 WX)

3702 93 /1B White
(RAL 9016)



3704

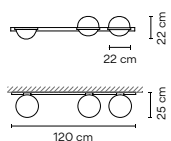

Light Source

4 x LED 4,6W 500mA.
LED 2700 K. CRI >90. 1736 lm. 94,34 lm/W.
Driver Constant Current 500mA.
220-240V. 50/60Hz.
Dimming: 1-10V, Push.

Personalization options available
- LED 3000 K / 4000 K.
- Dimming: DALI.
Min. quantity, upcharge and extra lead time apply.

Materials

Diffuser: Blown-glass.
Profile: Aluminum.
Planter: PMMA.

Packaging

2 Boxes.
Total Vol. 0,0081 m³.
Gross weight 6,2 Kg.
Net weight 3,9 Kg.

3704 18 /1B Graphite
(ADAPTA RF 9913 WX)

3704 93 /1B White
(RAL 9016)



3706

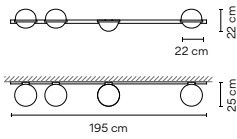

Light Source
 6 x LED 4,6W 500mA.
LED 2700 K. CRI >90. 2604 lm. 94,34 lm/W.
Driver Constant Current 500mA.
 220-240V. 50/60Hz.
Dimming: 1-10V, Push.
Personalization options available
 - LED 3000 K / 4000 K.
 - Dimming: DALI.
 Min. quantity, upcharge and extra lead time apply.

Materials
 Diffuser: Blown-glass.
 Profile: Aluminum.
 Planter: PMMA.
Packaging
 2 Boxes.
 Total Vol. 0,1793 m³.
 Gross weight 6,4 Kg.
 Net weight 3,9 Kg.

3706 18 /1B Graphite
 (ADAPTA RF 9913 WX)
3706 93 /1B White
 (RAL 9016)



3710

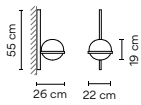

Light Source
 2 x LED 4,6W 500mA.
LED 2700 K. CRI >90. 868 lm. 94,34 lm/W.
Driver Constant Current 500mA.
 220-240V. 50/60Hz.
Dimming: 1-10V, Push.
Personalization options available
 - LED 3000 K / 4000 K.
 Min. quantity, upcharge and extra lead time apply.

Materials
 Diffuser: Blown-glass.
 Profile: Aluminum.
Packaging
 1 Box.
 0,57 x 0,31 x 0,21 m.
 Vol. 0,0382 m³.
 Gross weight 2,6 Kg.
 Net weight 1,8 Kg.

3710 18 /1B Graphite
 (ADAPTA RF 9913 WX)
3710 93 /1B White
 (RAL 9016)



3714

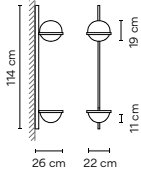

Light Source
 2 x LED 4,6W 500mA.
LED 2700 K. CRI >90. 868 lm. 94,34 lm/W.
Driver Constant Current 500mA.
 220-240V. 50/60Hz.
Dimming: 1-10V, Push.
Personalization options available
 - LED 3000 K / 4000 K.
 - Dimming: DALI.
 Min. quantity, upcharge and extra lead time apply.

Materials
 Diffuser: Blown-glass.
 Profile: Aluminum.
 Planter: PMMA.
Packaging
 2 Boxes.
 Total Vol. 0,0081 m³.
 Gross weight 5,2 Kg.
 Net weight 2,9 Kg.

3714 18 /1B Graphite
 (ADAPTA RF 9913 WX)
3714 93 /1B White
 (RAL 9016)



3716

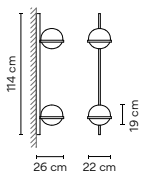

Light Source
 4 x LED 4,6W 500mA.
LED 2700 K. CRI >90. 1736 lm. 94,34 lm/W.
Driver Constant Current 500mA.
 220-240V. 50/60Hz.
Dimming: 1-10V, Push.
Personalization options available
 - LED 3000 K / 4000 K.
 - Dimming: DALI.
 Min. quantity, upcharge and extra lead time apply.

Materials
 Diffuser: Blown-glass.
 Profile: Aluminum.
Packaging
 2 Boxes.
 Total Vol. 0,0081 m³.
 Gross weight 6,5 Kg.
 Net weight 4,2 Kg.

3716 18 /1B Graphite
 (ADAPTA RF 9913 WX)
3716 93 /1B White
 (RAL 9016)



3718

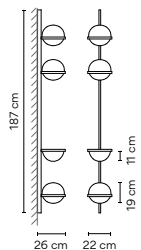

Light Source
 6 x LED 4,6W 500mA.
LED 2700 K. CRI >90. 2604 lm. 94,34 lm/W.
Driver Constant Current 500mA.
 220-240V. 50/60Hz.
Dimming: 1-10V, Push.
Personalization options available
 - LED 3000 K / 4000 K.
 - Dimming: DALI.
 Min. quantity, upcharge and extra lead time apply.

Materials
 Diffuser: Blown-glass.
 Profile: Aluminum.
 Planter: PMMA.
Packaging
 2 Boxes.
 Total Vol. 0,1793 m³.
 Gross weight 8,6 Kg.
 Net weight 6,1 Kg.

3718 18 /1B Graphite
 (ADAPTA RF 9913 WX)
3718 93 /1B White
 (RAL 9016)



Pendants

3720

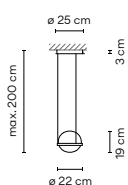

Light Source

2 x LED 4,6W 500mA.
LED 2700 K. CRI >90. 868 lm. 94,34 lm/W.
Driver Constant Current 500mA.
110-240V. 50/60Hz.
Dimming: 1-10V, Push.

Personalization options available

- LED 3000 K / 4000 K.
 - Dimming: DALI or Casambi.
 - Extra cable length.
- Min. quantity, upcharge and extra lead time apply.

Materials

Diffuser: Blown-glass.
Profile: Aluminum.

Packaging

1 Box.
0,71 x 0,27 x 0,21 m.
Vol. 0,0413 m³.
Gross weight 3,75 Kg.
Net weight 2,8 Kg.

3720 18 /1B Graphite
(ADAPTA RF 9913 WX)

3720 93 /1B White
(RAL 9016)



3724

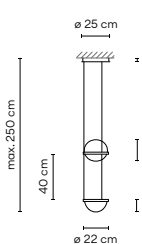

Light Source

2 x LED 4,6W 500mA.
LED 2700 K. CRI >90. 868 lm. 94,34 lm/W.
Driver Constant Current 500mA.
110-240V. 50/60Hz.
Dimming: 1-10V, Push.

Personalization options available

- LED 3000 K / 4000 K.
 - Dimming: DALI or Casambi.
 - Extra cable length.
- Min. quantity, upcharge and extra lead time apply.

Materials

Diffuser: Blown-glass.
Profile: Aluminum.
Planter: PMMA.

Packaging

1 Box.
1,02 x 0,27 x 0,21 m.
Vol. 0,0588 m³.
Gross weight 4,6 Kg.
Net weight 3,3 Kg.

3724 18 /1B Graphite
(ADAPTA RF 9913 WX)

3724 93 /1B White
(RAL 9016)



3726

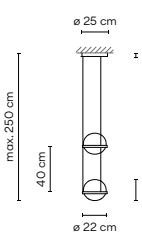

Light Source

4 x LED 4,6W 500mA.
LED 2700 K. CRI >90. 1736 lm. 94,34 lm/W.
Driver Constant Current 500mA.
110-240V. 50/60Hz.
Dimming: 1-10V, Push.

Personalization options available

- LED 3000 K / 4000 K.
 - Dimming: DALI or Casambi.
 - Extra cable length.
- Min. quantity, upcharge and extra lead time apply.

Materials

Diffuser: Blown-glass.
Profile: Aluminum.

Packaging

1 Box.
1,02 x 0,27 x 0,21 m.
Vol. 0,0588 m³.
Gross weight 5,4 Kg.
Net weight 4,1 Kg.

3726 18 /1B Graphite
(ADAPTA RF 9913 WX)

3726 93 /1B White
(RAL 9016)



3728

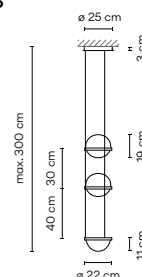

Light Source

4 x LED 4,6W 500mA.
LED 2700 K. CRI >90. 1736 lm. 94,34 lm/W.
Driver Constant Current 500mA.
110-240V. 50/60Hz.
Dimming: 1-10V, Push.

Personalization options available

- LED 3000 K / 4000 K.
 - Dimming: DALI or Casambi.
 - Extra cable length.
- Min. quantity, upcharge and extra lead time apply.

Materials

Diffuser: Blown-glass.
Profile: Aluminum.
Planter: PMMA.

Packaging

1 Box.
0,75 x 0,53 x 0,21 m.
Vol. 0,0857 m³.
Gross weight 8,8 Kg.
Net weight 4,7 Kg.

3728 18 /1B Graphite
(ADAPTA RF 9913 WX)

3728 93 /1B White
(RAL 9016)



3730

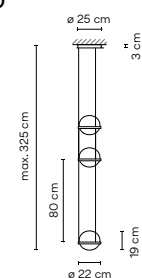

Light Source

6 x LED 4,6W 500mA.
LED 2700 K. CRI >90. 2604 lm. 94,34 lm/W.
Driver Constant Current 500mA.
110-240V. 50/60Hz.
Dimming: 1-10V, Push, DALI.

Personalization options available

- LED 3000 K / 4000 K.
 - Dimming: Casambi.
 - Extra cable length.
- Min. quantity, upcharge and extra lead time apply.

Materials

Diffuser: Blown-glass.
Profile: Aluminum.

Packaging

1 Box.
0,75 x 0,53 x 0,21 m.
Vol. 0,0857 m³.
Weight 9,5 Kg.
Net weight 5,4 Kg.

3730 18 /1A Graphite
(ADAPTA RF 9913 WX)

3730 93 /1A White
(RAL 9016)

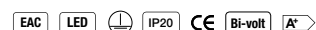

3734

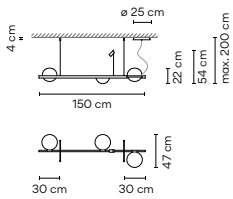

Light Source

1 x LED 2W 500mA.
4 x LED 4,6W 500mA.
LED 2700 K. CRI >90. 1829,9 lm. 89,7 lm/W.
Driver Constant Current 500mA.
110-240V. 50/60Hz.
Dimming: 1-10V, Push, DALI.

Personalization options available

- LED 3000 K / 4000 K.
- Dimming: Casambi.
- Extra cable length.
Min. quantity, upcharge and extra lead time apply.

Materials

Diffuser: Blown-glass.
Profile: Aluminum.
Planter: PMMA.

Packaging

1 Box.
1,72 x 0,33 x 0,31 m.
Vol. 0,1790 m³.
Gross weight 9,4 Kg.
Net weight 5,95 Kg.

3734 18 /1A Graphite
(ADAPTA RF 9913 WX)

3734 93 /1A White
(RAL 9016)



3736

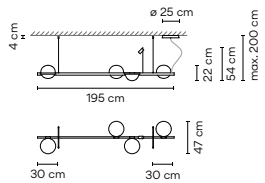

Light Source

1 x LED 2W 500mA.
6 x LED 4,6W 500mA.
LED 2700 K. CRI >90. 2730,7 lm. 92,25 lm/W.
Driver Constant Current 500mA.
110-240V. 50/60Hz.
Dimming: 1-10V, Push, DALI.

Personalization options available

- LED 3000 K / 4000 K.
- Dimming: Casambi.
- Extra cable length.
Min. quantity, upcharge and extra lead time apply.

Materials

Diffuser: Blown-glass.
Profile: Aluminum.
Planter: PMMA.

Packaging

2 Boxes.
Vol. 0,1793 m³.
Gross weight 9,1 Kg.
Net weight 6,6 Kg.

3736 18 /1A Graphite
(ADAPTA RF 9913 WX)

3736 93 /1A White
(RAL 9016)



Table

3740

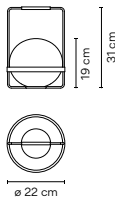

Light Source

2 x LED 4,6W 500mA.
LED 2700 K. CRI >90. 868 lm. 94,34 lm/W.
Driver Constant Current 500mA.
100-240V. 50/60Hz.
Dimming: Push.

Electric cable with plug and push-button (3m).

Personalization options available

- LED 3000 K / 4000 K.
Min. quantity, upcharge and extra lead time apply.

Materials

Diffuser: Blown-glass.
Profile: Aluminum.
Rods: Steel.

Packaging

1 Box.
0,24 x 0,24 x 0,49 m.
Vol. 0,0282 m³.
Gross weight 1,7 Kg.
Net weight 1,2 Kg.

3740 18 /15 Graphite
(ADAPTA RF 9913 WX)

3740 93 /15 White
(RAL 9016)



Plis Outdoor

Design by Ramos & Bassols

A surprising design which brings the warm atmosphere and textures of the indoors to the garden, terrace or porch. Breaking down boundaries between inside and outside.

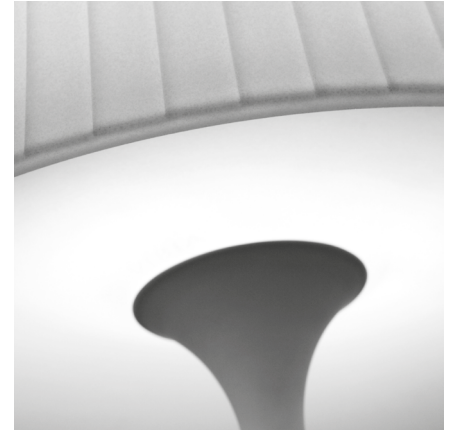

Outdoor

4030

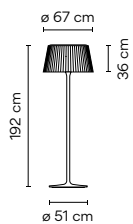

Light Source



2 x COMPACT FLUORESCENT
E27 230V 23W.

Portable version. Surface cable 3,5 m.

Materials

Diffuser: Polyethylene.
Base: Polyurethane foam.
Lid: Steel.

Packaging

1 Box.
1,99 x 0,75 x 0,76 m.
Vol. 1,1430 m³.
Gross weight 40,5 Kg.
Net weight 29,5 Kg.

4030 03 White
(RAL 9016)



4035

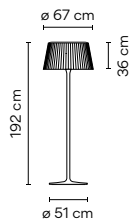

Light Source



2 x COMPACT FLUORESCENT
E27 230V 23W.

Built-in cable.

Materials

Diffuser: Polyethylene.
Base: Polyurethane foam.
Lid: Steel.

Packaging

1 Box.
1,99 x 0,75 x 0,76 m.
Vol. 1,1430 m³.
Gross weight 40,5 Kg.
Net weight 29,5 Kg.

4035 03 White
(RAL 9016)



Wind

Design by Jordi Vilardell

A perfect marriage of technology and tradition. Wind's drum shade is made of fibreglass, an innovative webbed texture and pattern that elevates the visual contribution of this timeless silhouette.



Outdoor

4055

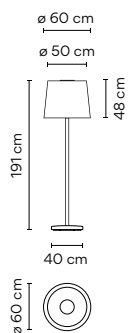

Light Source



1 x 2GX13 230V 40W (T5C).

Portable version.
Electric cable 3,5 m.

Materials

Shade: Filament winding.
Weight: Concrete.
Lid: Steel.
Diffuser: Methacrylate.

Packaging

2 Boxes.
Total Vol. 1,0300 m³.
Gross weight 45,1 Kg.
Net weight 27,8 Kg.

4055 03 White
(RAL 9016)

4055 04 Black
(RAL 9005)

4055 07 Green
(RAL 6018)

4055 08 Orange
(RAL 2008)



UNTIL STOCK RUNS OUT

4057

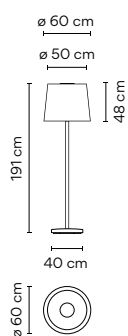

New

Light Source



1 x LED PLATE 25W 700mA.
LED 2700 K. CRI >90. 3480 lm. 139,2 lm/W.
Driver Constant Current 700mA.
110-240V. 50/60Hz.

Portable version.
Electric cable 3,5 m.

Materials

Shade: Filament winding.
Weight: Concrete.
Lid: Steel.
Diffuser: Methacrylate.

Packaging

2 Boxes.
Total Vol. 1,0300 m³.
Gross weight 45,1 Kg.
Net weight 27,8 Kg.

4057 27 /10 Brown L1
(NCS S 1505-Y50R)

4057 53 /10 Green M1
(NCS S 6005-G80Y)

4057 61 /10 Ocre red
(NCS S 3050-Y60R)



AVAILABLE FROM JUNE

4060

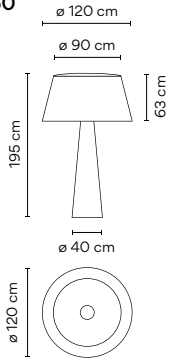

Light Source

1 x 2GX13 230V 60W (T5C).
1 x LED 2,4W 700mA.
Led 3100 K. CRI >80. 181 lm. 86 lm/W.
Driver Constant Current 700mA.
220-240V. 50/60Hz.

Portable version.
Electric cable 3 m.

Materials

Shade: Filament winding.
Base: Filament winding.
Diffuser: Methacrylate.

Packaging

4 Boxes.
Total Vol. 2,3500 m³.
Gross weight 95 Kg.
Net weight 75 Kg.

4060 03 White fiberglass
(RAL 9016)

4060 07 Green fiberglass
(RAL 6018)

4060 08 Orange fiberglass
(RAL 2008)



UNTIL STOCK RUNS OUT

4062

New

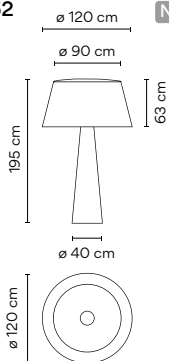

Light Source

3 x LED PLATE 25W 700mA.
1 x LED 2,4W 700mA.
LED 2700 K. CRI >90. 10440 lm. 139,2 lm/W.
Driver Constant Current 700mA.
110-240V. 50/60Hz.

Portable version.
Electric cable 3 m.

Materials

Base: Filament winding.
Shade: Filament winding.
Diffuser: Methacrylate.

Packaging

4 Boxes.
Total Vol. 2,3500 m³.
Gross weight 95 Kg.
Net weight 75 Kg.

4062 27 / 10 Brown L1
(NCS S 1505-Y50R)

4062 53 / 10 Green M1
(NCS S 6005-G80Y)

4062 61 / 10 Ocre red
(NCS S 3050-Y60R)



AVAILABLE FROM JUNE

4065

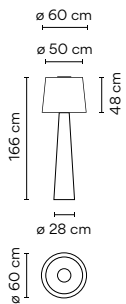

Light Source

1 x 2GX13 230V 22W (T5C).
1 x LED 2,4W 700mA.
Led 3100 K. CRI >80. 181 lm. 86 lm/W.
Driver Constant Current 700mA.
220-240V. 50/60Hz.

Portable version.
Electric cable 3 m.

Materials

Shade: Filament winding.
Base: Filament winding.
Diffuser: Methacrylate.

Packaging

3 Boxes.
Total Vol. 1,5000 m³.
Gross weight 50 Kg.
Net weight 30,5 Kg.

4065 03 White fiberglass
(RAL 9016)

4065 07 Green fiberglass
(RAL 6018)

4065 08 Orange fiberglass
(RAL 2008)



UNTIL STOCK RUNS OUT

4067

New

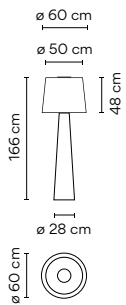

Light Source

1 x LED PLATE 25W 700mA.
1 x LED 2,4W 700mA.
LED 2700 K. CRI >90. 3480 lm. 139,2 lm/W.
Driver Constant Current 700mA.
110-240V. 50/60Hz.

Portable version.
Electric cable 3 m.

Materials

Shade: Filament Winding.
Base: Filament Winding.
Diffuser: Methacrylate.

Packaging

3 Boxes
Total Vol. 1,5000 m³.
Gross weight 50 Kg.
Net weight 30,5 Kg.

4067 27 / 10 Brown L1
(NCS S 1505-Y50R)

4067 53 / 10 Green M1
(NCS S 6005-G80Y)

4067 61 / 10 Ocre red
(NCS S 3050-Y60R)



AVAILABLE FROM JUNE

Wind

Pendants

4070

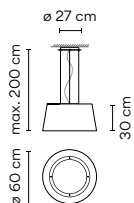

Light Source



1 x 2GX13 230V 40W (T5C).

Surface mounted.

Personalization options available

- Extra cable length.
Min. quantity, upcharge and extra lead time apply.

Materials

Shade: Filament winding.
Canopy Plate: Steel.
Lid: Steel.
Diffuser: Methacrylate.

Packaging

1 Box.
0,50 x 0,77 x 0,77 m.
Vol. 0,2970 m³.
Gross weight 13 Kg.
Net weight 9 Kg.

4070 03 White
(RAL 9016)

4070 04 Black
(RAL 9005)

4070 07 Green
(RAL 6018)

4070 08 Orange
(RAL 2008)

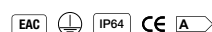

UNTIL STOCK RUNS OUT

4072

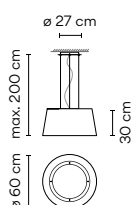

New

Light Source



1 x LED PLATE 25W 700mA.
LED 2700 K. CRI >90. 3480 lm. 139,2 lm/W.
Driver Constant Current 700mA.
110-240V. 50/60Hz.

Surface mounted.

Personalization options available

- Extra cable length.
Min. quantity, upcharge and extra lead time apply.

Materials

Shade: Filament winding.
Canopy Plate: Steel.
Lid: Steel.
Diffuser: Methacrylate.

Packaging

1 Box.
0,50 x 0,77 x 0,77 m.
Vol. 0,2970 m³.
Gross weight 13 Kg.
Net weight 9 Kg.

4072 27 /10 Brown L1
(S 1505-Y50R)

4072 53 /10 Green M1
(S 6005-G80Y)

4072 61 /10 Ocre red
(S 3050-Y60R)



AVAILABLE FROM JUNE

4075

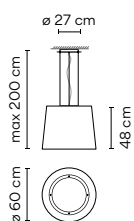

Light Source



1 x 2GX13 230V 40W (T5C).

Surface mounted.

Personalization options available

- Extra cable length.
Min. quantity, upcharge and extra lead time apply.

Materials

Shade: Filament winding.
Canopy Plate: Steel.
Lid: Steel.
Diffuser: Methacrylate.

Packaging

1 Box.
0,50 x 0,77 x 0,77 m.
Vol. 0,2970 m³.
Gross weight 14 Kg.
Net weight 9,5 Kg.

4075 03 White
(RAL 9016)

4075 04 Black
(RAL 9005)

4075 07 Green
(RAL 6018)

4075 08 Orange
(RAL 2008)

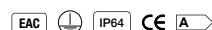

UNTIL STOCK RUNS OUT

4076

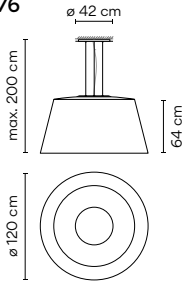

Light Source

○
1 x 2GX13 230V 40W (T5C).

Indoor only.

Personalization options available

- Extra cable length.
Min. quantity, upcharge and extra lead time apply.

Materials

Shade: Filament winding.
Canopy Plate: Steel.
Lid: Steel.
Diffuser: Methacrylate.

Packaging

1 Box.
0,74 x 1,24 x 1,27 m.
Vol. 1,1300 m³.
Gross weight 38 Kg.
Net weight 30 Kg.

4076 03 White
(RAL 9016)

4076 07 Green
(RAL 6018)

4076 08 Orange
(RAL 2008)



UNTIL STOCK RUNS OUT

4077

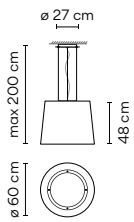

New

Light Source

⊕
1 x LED PLATE 25W 700mA.
LED 2700 K. CRI >90. 3480 lm. 139,2 lm/W.
Driver Constant Current 700mA.
110-240V. 50/60Hz.

Surface mounted.

Personalization options available

- Extra cable length.
Min. quantity, upcharge and extra lead time apply.

Materials

Shade: Filament winding.
Canopy Plate: Steel.
Lid: Steel.
Diffuser: Methacrylate.

Packaging

1 Box.
0,50 x 0,77 x 0,77 m.
Vol. 0,2970 m³.
Gross weight 14 Kg.
Net weight 9,5 Kg.

4077 27 /10 Brown L1
(S 1505-Y50R)

4077 53 /10 Green M1
(S 6005-G80Y)

4077 61 /10 Ocre red
(S 3050-Y60R)



AVAILABLE FROM JUNE

4078

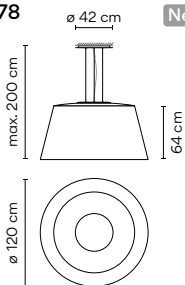

New

Light Source

⊕
3 x LED PLATE 25W 700mA.
LED 2700 K. CRI >90. 10440 lm. 139,2 lm/W.
Driver Constant Current 700mA.
110-240V. 50/60Hz.

Indoor only.

Personalization options available

- Extra cable length.
Min. quantity, upcharge and extra lead time apply.

Materials

Shade: Filament winding.
Canopy Plate: Steel.
Lid: Steel.
Diffuser: Methacrylate.

Packaging

1 Box.
0,74 x 1,24 x 1,27 m.
Vol. 1,1300 m³.
Gross weight 38 Kg.
Net weight 30 Kg.

4078 27 /10 Brown L1
(S 1505-Y50R)

4078 53 /10 Green M1
(S 6005-G80Y)

4078 61 /10 Ocre red
(S 3050-Y60R)



AVAILABLE FROM JUNE

Break

Design by Xuclà & Alemany

Resembling an avant-garde sculpture, Break is distinguished by its architectural attitude. The cubic volumes angle provides down light, while doubling as sculptural outdoor presence.



Outdoor

<p>4101</p>	<p>Light Source</p> <p>☉</p> <p>1 x LED 6,2W 350mA. Led 2700 K. CRI >80. 580 lm. 94 lm/W. Driver Constant Current 350mA. 100-240V. 50/60Hz.</p> <p>Personalization options available - LED 3000 K / 4000 K. Min. quantity, upcharge and extra lead time apply.</p>	<p>Materials</p> <p>Head: Polyurethane / Concrete. Base: Polyurethane / Concrete. Diffuser: Methacrylate.</p> <p>Packaging</p> <p>1 Box. 0,88 x 0,35 x 0,34 m. Vol. 0,1032 m³. Gross weight 07 and 54 11,8 Kg. Net weight 07 and 54 7,25 Kg. Gross weight 80 38,9 Kg. Net weight 80 35,01 Kg.</p>	<p>4101 07 /10 Khaki (RAL 7006)</p> <hr/> <p>4101 54 /10 Oxide (RAL 8014)</p> <hr/> <p>4101 80 /10 Concrete (Natural finish)</p> <hr/> <p>EAC LED IP66 CE Bi-volt A+</p>
<p>4106</p>	<p>Light Source</p> <p>☉</p> <p>1 x LED 6,2W 350mA. Led 2700 K. CRI >80. 580 lm. 94 lm/W. Driver Constant Current 350mA. 100-240V. 50/60Hz.</p> <p>Personalization options available - LED 3000 K / 4000 K. Min. quantity, upcharge and extra lead time apply.</p>	<p>Materials</p> <p>Head: Polyurethane / Concrete. Base: Polyurethane / Concrete. Diffuser: Methacrylate.</p> <p>Packaging</p> <p>1 Box. 0,51 x 0,35 x 0,34 m. Vol. 0,0598 m³. Gross weight 07 and 54 7,60 Kg. Net weight 07 and 54 4,65 Kg. Gross weight 80 21,5 Kg. Net weight 80 19,35 Kg.</p>	<p>4106 07 /10 Khaki (RAL 7006)</p> <hr/> <p>4106 54 /10 Oxide (RAL 8014)</p> <hr/> <p>4106 80 /10 Concrete (Natural finish)</p> <hr/> <p>EAC LED IP66 CE Bi-volt A+</p>

4108

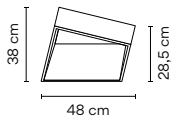

Light Source

2 x LED Strip 9,2W 400mA.
Led 2700 K. CRI >80.
 2500 lm. 118 lm/W.
Driver Constant Current 300mA.
 220-240V. 50/60Hz.

Personalization options available
 - LED 3000 K / 4000 K.
 Min. quantity, upcharge and extra lead time apply.

Materials

Body: Steel.
 Diffuser: Methacrylate.

Packaging

1 Box.
 0,49 x 0,51 x 0,52 m.
 Vol. 0,1312 m³.
 Gross weight 6,6 Kg.
 Net weight 16 Kg.

4108 07 /10 Khaki
 (RAL 7006)

4108 54 /10 Oxide
 (RAL 8014)



4110

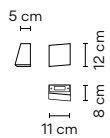

Light Source

1 x LED 2,1W 700mA.
Led 2700 K. CRI >80.
 199 lm. 95 lm/W.
Driver Constant Current 700mA.
 100-240V. 50/60Hz.

Personalization options available
 - LED 3000 K / 4000 K.
 Min. quantity, upcharge and extra lead time apply.

Materials

Body: Aluminum / Concrete.
 Diffuser: Methacrylate.

Packaging

1 Box
 0,260 x 0,260 x 0,260 m.
 Vol. 1,0000 m³.
 Gross weight 2,30 Kg.
 Net weight 2,07 Kg.

4110 07 /10 Khaki
 (RAL 7006)

4110 54 /10 Oxide
 (RAL 8014)

4110 80 /10 Concrete
 (Natural finish)



Empty

Design by Xuclà

A sculpture by day and lighting by night, this outdoor fixture embodies multifunctional design. Its crisp angles create a cantilevered perch that serves as a side table or stool.



Outdoor

<p>4125</p>	<p>Light Source</p> <p>2 x LED STRIP 24V 8,6W. Led 3500 K. CRI >70. 1247 lm. 73 lm/W. Driver Constant Voltage 24V. 100-277V. 50/60Hz.</p> <p>Resistance to weight: 150 kg evenly distributed over the cantilevered surface of the lamp. This force should not be applied by impact.</p>	<p>Materials Body: Polymer concrete. Diffuser: Methacrylate.</p> <p>Packaging 1 Box. 0,56 x 0,50 x 0,50 m. Vol. 0,176 m³. Gross weight 40 Kg. Net weight 36 Kg.</p>	<p>4125 18 /30 Lacquered concrete grey (NCS S 2002-B50G)</p> <p>EAC LED IP66 CE Multi-volt A</p>
<p>4130</p>	<p>Light Source</p> <p>2 x LED STRIP 24V 8,6W. Led 3500 K. CRI >70. 1247 lm. 73 lm/W. Driver Constant Voltage 24V. 100-277V. 50/60Hz.</p> <p>Resistance to weight: 150 kg evenly distributed over the cantilevered surface of the lamp. This force should not be applied by impact.</p>	<p>Materials Body: Polymer concrete. Diffuser: Methacrylate.</p> <p>Packaging 1 Box. 0,56 x 0,56 x 0,81 m. Vol. 0,254 m³. Gross weight 54,7 Kg. Net weight 49,7 Kg.</p>	<p>4130 18 /30 Lacquered concrete grey (NCS S 2002-B50G)</p> <p>EAC LED IP66 CE Multi-volt A</p>
<p>4135</p>	<p>Light Source</p> <p>2 x LED STRIP 24V 4,3W. Led 3500 K. CRI >70. 567 lm. 66 lm/W. Driver Constant Voltage 24V. 100-240V. 50/60Hz.</p> <p>Resistance to weight: 150 kg evenly distributed over the cantilevered surface of the lamp. This force should not be applied by impact.</p>	<p>Materials Body: Polymer concrete. Diffuser: Methacrylate.</p> <p>Packaging 1 Box. 0,36 x 0,36 x 0,36 m. Vol. 0,04 m³. Gross weight 12,2 Kg. Net weight 10,4 Kg.</p>	<p>4135 18 /30 Lacquered concrete grey (NCS S 2002-B50G)</p> <p>EAC LED IP66 CE Bi-volt A</p>
<p>4136</p>	<p>Light Source</p> <p>2 x LED STRIP 24V 4,3W. Led 3500 K. CRI >70. 567 lm. 66 lm/W. Driver Constant Voltage 24V. 100-240V. 50/60Hz.</p> <p>Resistance to weight: 150 kg evenly distributed over the cantilevered surface of the lamp. This force should not be applied by impact.</p>	<p>Materials Body: Polymer concrete. Diffuser: Methacrylate.</p> <p>Packaging 1 Box. 0,36 x 0,36 x 0,65 m. Vol. 0,084 m³. Gross weight 22 Kg. Net weight 19 Kg.</p>	<p>4136 18 /30 Lacquered concrete grey (NCS S 2002-B50G)</p> <p>EAC LED IP66 CE Bi-volt A</p>

Fold Surface

Design by Arik Levy

Fold features a geometric design that creates a striking three-dimensional illumination effect. Light and shadow are projected from its cubic shapes, washing the wall with glowing chevron patterns.

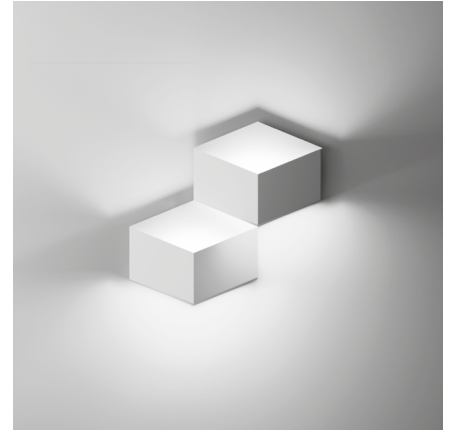

Wall

4200

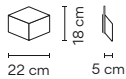

Light Source



2 x LED 2,1W 700mA.
Led 2700 K. CRI >80. 399 lm. 95 lm/W.
Driver Constant Current 700mA.
 100-240V. 50/60Hz.

Personalization options available

- Configuration layout at vibia.com
 - Finish customization.
 (Available options: Vibia color palette).
 - LED 3000 K / 4000 K.
- Min. quantity, upcharge and extra lead time apply.

Materials

Shade: Aluminum.
 Body: Aluminum.
 Diffuser: Polycarbonate.

Packaging

1 Box.
 0,26 x 0,26 x 0,16 m.
 Vol. 0,0116 m³.
 Gross weight 1,3 Kg.
 Net weight 0,8 Kg.

4200 07 /10 Green
 (PANTONE 385)

4200 14 /10 Chocolate
 (RAL 8019)

4200 58 /10 Off-white
 (RAL D2 1109005)



4201

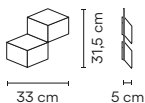

Light Source



4 x LED 2,1W 700mA.
Led 2700 K. CRI >80. 797 lm. 95 lm/W.
Driver Constant Current 700mA.
 100-240V. 50/60Hz.

Personalization options available

- Configuration layout at vibia.com
 - Finish customization.
 (Available options: Vibia color palette).
 - LED 3000 K / 4000 K.
- Min. quantity, upcharge and extra lead time apply.

Materials

Shade: Aluminum.
 Body: Aluminum.
 Diffuser: Polycarbonate.

Packaging

1 Box.
 0,41 x 0,41 x 0,21 m.
 Vol. 0,0353 m³.
 Gross weight 2,8 Kg.
 Net weight 1,6 Kg.

4201 07 /10 Green
 (PANTONE 385)

4201 14 /10 Chocolate
 (RAL 8019)

4201 58 /10 Off-white
 (RAL D2 1109005)



Fold Surface

4202

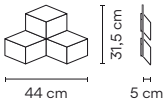

Light Source



6 x LED 2,1W 700mA.
Led 2700 K. CRI >80. 1196 lm. 95 lm/W.
Driver Constant Current 700mA.
 100-240V. 50/60Hz.

Personalization options available

- Configuration layout at vibia.com
- Finish customization.
 (Available options: Vibia color palette).
- LED 3000 K / 4000 K.

Min. quantity, upcharge and extra lead time apply.

Materials

Shade: Aluminum.
 Body: Aluminum.
 Diffuser: Polycarbonate.

Packaging

1 Box.
 0,17 x 0,51 x 0,51 m.
 Vol. 0,0429 m³.
 Gross weight 4,2 Kg.
 Net weight 2,4 Kg.

4202 07 /10 Green
 (PANTONE 385)

4202 14 /10 Chocolate
 (RAL 8019)

4202 58 /10 Off-white
 (RAL D2 1109005)



4204

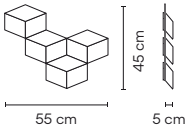

Light Source



8 x LED 2,1W 700mA.
Led 2700 K. CRI >80. 1594 lm. 95 lm/W.
Driver Constant Current 700mA.
 100-240V. 50/60Hz.

Personalization options available

- Configuration layout at vibia.com
- Finish customization.
 (Available options: Vibia color palette).
- LED 3000 K / 4000 K.

Min. quantity, upcharge and extra lead time apply.

Materials

Shade: Aluminum.
 Body: Aluminum.
 Diffuser: Polycarbonate.

Packaging

1 Box.
 0,27 x 0,60 x 0,60 m.
 Vol. 0,0972 m³.
 Gross weight 5,7 Kg.
 Net weight 3,2 Kg.

4204 07 /10 Green
 (PANTONE 385)

4204 14 /10 Chocolate
 (RAL 8019)

4204 58 /10 Off-white
 (RAL D2 1109005)



Up

Design by Ramos & Bassols

Inspired by the look of neoclassical cornices, Up blends seamlessly into the ceiling. With its flat LED diffusion system and refined rim, it gives the appearance of uniform light passing from an opening in the ceiling through a sleek frame.



Ceiling

4440

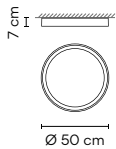

Light Source



1 x LED PLATE 26,5W 700mA.
/ 1A:
 LED 2700 K. CRI >80. 2482 lm. 94 lm/W.
/ 4A:
 LED 4000 K. CRI >80. 2982 lm. 113 lm/W.
Driver Constant Current 700mA.
 110-240V. 50/60Hz.
Dimming: DALI, 1-10V, Push.

Personalization options available

- Finish customization.
 (Available options: Vibia color palette).
- Dimming: Casambi.

Min. quantity, upcharge and extra lead time apply.

Materials

Diffuser: Polycarbonate.
 Body: Aluminum.
 Ceiling support: Steel.

Packaging

1 Box.
 0,17 x 0,55 x 0,55 m.
 Vol. 0,0514 m³.
 Gross weight 11 Kg.
 Net weight 7,5 Kg.

4440 18 /1A Graphite
 (RAL 7016).

4440 18 /4A Graphite
 (RAL 7016).

4440 93 /1A White
 (RAL 9016).

4440 93 /4A White
 (RAL 9016).



4442

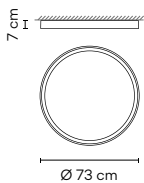

Light Source



1 x LED PLATE 55,3W 750mA.
/ 1A:
 LED 2700 K. CRI >80. 5127 lm. 93 lm/W.
/ 4A:
 LED 4000 K. CRI >80. 6159 lm. 111 lm/W.
Driver Constant Current 750mA.
 110-240V. 50/60Hz.
Dimming: DALI, 1-10V, Push.

Personalization options available

- Finish customization.
 (Available options: Vibia color palette).
- Dimming: Casambi.

Min. quantity, upcharge and extra lead time apply.

Materials

Diffuser: Polycarbonate.
 Body: Aluminum.
 Ceiling support: Steel.

Packaging

1 Box.
 0,17 x 0,90 x 0,90 m.
 Vol. 0,1377 m³.
 Gross weight 13 Kg.
 Net weight 15 Kg.

4442 18 /1A Graphite
 (RAL 7016).

4442 18 /4A Graphite
 (RAL 7016).

4442 93 /1A White
 (RAL 9016).

4442 93 /4A White
 (RAL 9016).

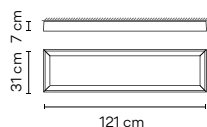

4452

**Light Source**

1 x LED PLATE 50W 900mA.
 / 1A: LED 2700 K. CRI >80. 3957 lm. 79 lm/W.
 / 4A: LED 4000 K. CRI >80. 4754 lm. 95 lm/W.
 Driver Constant Current 900mA.
 110-240V. 50/60Hz.
 Dimming: 1-10V, DALI, Push.

Personalization options available

- Finish customization.
 (Available options: Vibia color palette).
 - Dimming: Casambi.
 Min. quantity, upcharge and extra lead time apply.

Materials

Diffuser: Polycarbonate.
 Body: Aluminum.
 Ceiling support: Steel.

Packaging

1 Box.
 0,17 x 0,42 x 1,31 m.
 Vol. 0,0924 m³.
 Gross weight 14 Kg.
 Net weight 12 Kg.

4452 18 /1A Graphite
 (RAL 7016).

4452 18 /4A Graphite
 (RAL 7016).

4452 93 /1A White
 (RAL 9016).

4452 93 /4A White
 (RAL 9016).

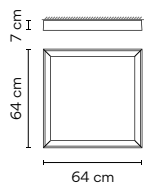

4454

**Light Source**

1 x LED PLATE 50W 900mA.
 / 1A: LED 2700 K. CRI >80. 3957 lm. 79 lm/W.
 / 4A: LED 4000 K. CRI >80. 4754 lm. 95 lm/W.
 Driver Constant Current 900mA.
 110-240V. 50/60Hz.
 Dimming: 1-10V, DALI, Push.

Personalization options available

- Finish customization.
 (Available options: Vibia color palette).
 - Dimming: Casambi.
 Min. quantity, upcharge and extra lead time apply.

Materials

Diffuser: Polycarbonate.
 Body: Aluminum.
 Ceiling support: Steel.

Packaging

1 Box.
 0,17 x 0,73 x 0,73 m.
 Vol. 0,0905 m³.
 Gross weight 14 Kg.
 Net weight 13 Kg.

4454 18 /1A Graphite
 (RAL 7016).

4454 18 /4A Graphite
 (RAL 7016).

4454 93 /1A White
 (RAL 9016).

4454 93 /4A White
 (RAL 9016).

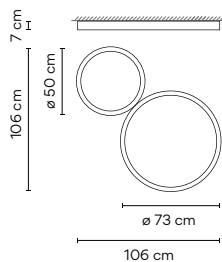

4460

**Light Source**

1 x LED PLATE 26,5W 700mA.
 1 x LED PLATE 55,3W 750mA.
 / 1A: LED 2700 K. CRI >80. 7608 lm. 93 lm/W.
 / 4A: LED 4000 K. CRI >80. 9141 lm. 112 lm/W.
 Driver Constant Current 700/750mA.
 110-240V. 50/60Hz.
 Dimming: 1-10V, DALI, Push.

Only one electric connection point.

Personalization options available

- Finish customization.
 (Available options: Vibia color palette).
 - Dimming: Casambi.
 Min. quantity, upcharge and extra lead time apply.

Materials

Diffuser: Polycarbonate.
 Body: Aluminum.
 Ceiling support: Steel.

Packaging

2 Boxes.
 Total Vol. 0,1891 m³.
 Gross weight 24 Kg.
 Net weight 23 Kg.

4460 18 /1A Graphite
 (RAL 7016).

4460 18 /4A Graphite
 (RAL 7016).

4460 93 /1A White
 (RAL 9016).

4460 93 /4A White
 (RAL 9016).



Origami

Design by Ramón Esteve

Recalling the folded paper of the Japanese art form for which it's named, Origami generates a stunning play of light and shadows. Composed of two architectural modules that be arranged in countless personalized designs, it creates the effect of climbing ivy along a blank expanse of wall.



Create your product configuration quickly and easily at vibia.com

Go to vibia.com and discover the quickest, most efficient way to configure a unique lighting mural with Origami.

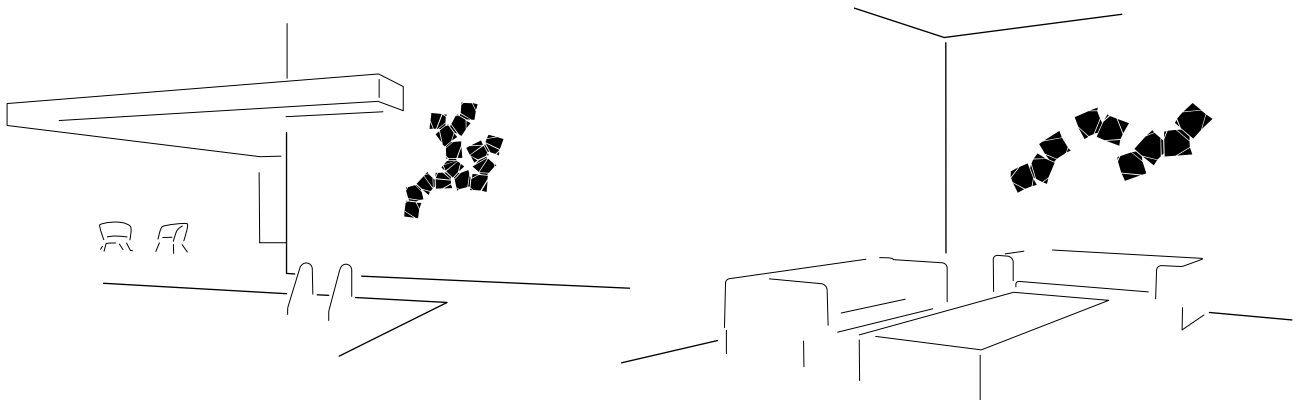

Wall Outdoor

4500

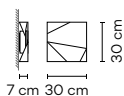

Light Source

1 x LED STRIP 6,3W 350mA.
LED 2700 K. CRI >80. 756 lm. 120 lm/W.
Driver Constant Current 350mA.
220-240V. 50/60Hz.
Dimming: TRIAC.

A maximum of 30 modules can be connected to a single connection point. For bigger compositions, check connection system.

Personalization options available

- Configuration layout at vibia.com
- LED 3000 K / 4000 K.
Min. quantity, upcharge and extra lead time apply.

Materials

Shade: ABS.
Diffuser: Polycarbonate.
Lid: Polycarbonate.
Arm: Polycarbonate.

Packaging

1 Box.
0,35 x 0,35 x 0,12 m.
Vol. 0,0150 m³.
Gross weight 1,5 Kg.
Net weight 1 Kg.

4500 10 /14 White
(NCS S 0300-N).

4500 29 /14 Brown D1
(NCS S 8005-Y50R).

4500 38 /14 Terra Dark
(NCS S 5040-Y70R).

4500 53 /14 Green M1
(NCS S 6005-G80Y).



Origami

4501

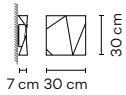

Light Source

1 x LED STRIP 6,3W 350mA.
LED 2700 K. CRI >80. 756 lm. 120 lm/W.
Driver Constant Current 350mA.
220-240V. 50/60Hz.
Dimming: TRIAC.

A maximum of 30 modules can be connected to a single connection point. For bigger compositions, check connection system.

Personalization options available

- Configuration layout at vibia.com
- LED 3000 K / 4000 K.

Min. quantity, upcharge and extra lead time apply.

Materials

Shade: ABS.
Diffuser: Polycarbonate.
Lid: Polycarbonate.
Arm: Polycarbonate.

Packaging

1 Box.
0,35 x 0,35 x 0,12 m.
Vol. 0,0150 m³.
Gross weight 1,5 Kg.
Net weight 1 Kg.

4501 10 /14 White
(NCS S 0300-N).

4501 29 /14 Brown D1
(NCS S 8005-Y50R).

4501 38 /14 Terra Dark
(NCS S 5040-Y70R).

4501 53 /14 Green M1
(NCS S 6005-G80Y).



4504

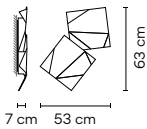

Light Source

2 x LED STRIP 6,3W 350mA.
LED 2700 K. CRI >80. 1513 lm. 120 lm/W.
Driver Constant Current 350mA.
220-240V. 50/60Hz.
Dimming: TRIAC.

A maximum of 30 modules can be connected to a single connection point. For bigger compositions, check connection system.

Personalization options available

- Configuration layout at vibia.com
- LED 3000 K / 4000 K.

Min. quantity, upcharge and extra lead time apply.

Materials

Shade: ABS.
Diffuser: Polycarbonate.
Lid: Polycarbonate.
Arm: Polycarbonate.

Packaging

2 Boxes.
Total Vol. 0,1003 m³.
Gross weight 4,05 Kg.
Net weight 2,15 Kg.

4504 10 /14 White
(NCS S 0300-N).

4504 29 /14 Brown D1
(NCS S 8005-Y50R).

4504 38 /14 Terra Dark
(NCS S 5040-Y70R).

4504 53 /14 Green M1
(NCS S 6005-G80Y).



4506

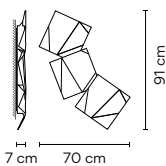

Light Source

3 x LED STRIP 6,3W 350mA.
LED 2700 K. CRI >80. 2269 lm. 120 lm/W.
Driver Constant Current 350mA.
220-240V. 50/60Hz.
Dimming: TRIAC.

A maximum of 30 modules can be connected to a single connection point. For bigger compositions, check connection system.

Personalization options available

- Configuration layout at vibia.com
- LED 3000 K / 4000 K.

Min. quantity, upcharge and extra lead time apply.

Materials

Shade: ABS.
Diffuser: Polycarbonate.
Lid: Polycarbonate.
Arm: Polycarbonate.

Packaging

2 Boxes.
Total Vol. 0,1378 m³.
Gross weight 5,33 Kg.
Net weight 3,23 Kg.

4506 10 /14 White
(NCS S 0300-N).

4506 29 /14 Brown D1
(NCS S 8005-Y50R).

4506 38 /14 Terra Dark
(NCS S 5040-Y70R).

4506 53 /14 Green M1
(NCS S 6005-G80Y).



4508

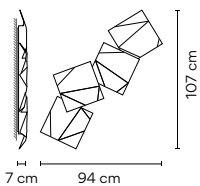

Light Source

4 x LED STRIP 6,3W 350mA.
LED 2700 K. CRI >80. 3026 lm. 120 lm/W.
Driver Constant Current 350mA.
220-240V. 50/60Hz.
Dimming: TRIAC.

A maximum of 30 modules can be connected to a single connection point. For bigger compositions, check connection system.

Personalization options available

- Configuration layout at vibia.com
- LED 3000 K / 4000 K.

Min. quantity, upcharge and extra lead time apply.

Materials

Shade: ABS.
Diffuser: Polycarbonate.
Lid: Polycarbonate.
Arm: Polycarbonate.

Packaging

2 Boxes.
Total Vol. 0,1943 m³.
Gross weight 6,55 Kg.
Net weight 4,3 Kg.

4508 10 /14 White
(NCS S 0300-N).

4508 29 /14 Brown D1
(NCS S 8005-Y50R).

4508 38 /14 Terra Dark
(NCS S 5040-Y70R).

4508 53 /14 Green M1
(NCS S 6005-G80Y).



Palo Alto

Design by Xuclà

At once natural and architectural, Palo Alto creates the effect of illuminated landscaping. Its angular, tree-shaped silhouette integrates seamlessly with the outdoors whether displayed individually or in a group.



Outdoor

4510

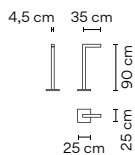

Light Source



2 x LED 2,2W 700mA.
LED 2700 K. CRI >80. 362 lm. 82,2 lm/W.
Driver Constant Current 700mA.
220-240V. 50/60Hz.

Materials

Body: Steel.
Lid: Steel.
Diffuser: Polycarbonate.

Packaging

1 Box.
0,446 x 0,408 x 1,108 m.
Vol. 0,2080 m³.
Gross weight 11,1 Kg.
Net weight 10 Kg.

4510 29 /10 Brown D1
(\$ 8005-Y50R)

4510 53 /10 Green M1
(\$ 6005-G80Y)



AVAILABLE FROM JUNE

4515

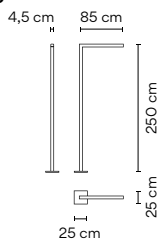

Light Source

1 x LED MODULE 24V 15W.
LED 2700 K. CRI >80. 1200 lm. 80 lm/W.
Driver Constant Voltage 24V.
100-277V. 50/60Hz.

Materials

Body: Steel.
Lid: Steel.
Diffuser: Polycarbonate.

Packaging

1 Box.
0,32 x 0,32 x 2,64 m.
Vol. 0,2703 m³.
Gross weight 18,4 Kg.
Net weight 16,5 Kg.

4515 29 /10 Brown D1
(\$ 8005-Y50R)

4515 53 /10 Green M1
(\$ 6005-G80Y)



AVAILABLE FROM JUNE

4520

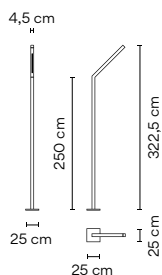

Light Source

1 x LED MODULE 24V 15W.
LED 2700 K. CRI >80. 1200 lm. 80 lm/W.
Driver Constant Voltage 24V.
100-277V. 50/60Hz.

Materials

Body: Steel.
Lid: Steel.
Diffuser: Polycarbonate.

Packaging

1 Box.
0,32 x 0,32 x 2,62 m.
Vol. 0,2640 m³.
Gross weight 13,75 Kg.
Net weight 11 Kg.

4520 29 /10 Brown D1
(\$ 8005-Y50R)

4520 53 /10 Green M1
(\$ 6005-G80Y)



AVAILABLE FROM JUNE

Palo Alto

4525

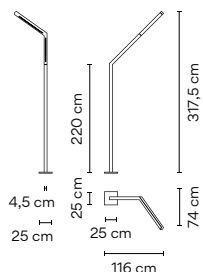

Light Source

2 x LED MODULE 24V 15W.
LED 2700 K. CRI >80. 1200 lm. 80 lm/W.
Driver Constant Voltage 24V.
100-277V. 50/60Hz.

Materials

Body: Steel.
Lid: Steel.
Diffuser: Polycarbonate.

Packaging

1 Box.
0,32 x 0,32 x 2,64 m.
Vol. 0,2703 m³
Gross weight 19,3 Kg.
Net weight 17,37 Kg.

4525 29 /10 Brown D1
(S 8005-Y50R)

4525 53 /10 Green M1
(S 6005-G80Y)



AVAILABLE FROM JUNE

4530

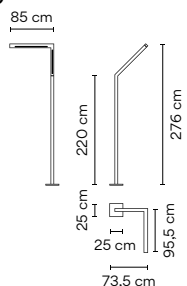

Light Source

2 x LED MODULE 24V 15W.
LED 2700 K. CRI >80. 1200 lm. 80 lm/W.
Driver Constant Voltage 24V.
100-277V. 50/60Hz.

Materials

Body: Steel.
Lid: Steel.
Diffuser: Polycarbonate.

Packaging

1 Box.
0,29 x 0,29 x 2,60 m.
Vol. 0,2180 m³
Gross weight 19,2 Kg.
Net weight 17,28 Kg.

4530 29 /10 Brown D1
(S 8005-Y50R)

4530 53 /10 Green M1
(S 6005-G80Y)



AVAILABLE FROM JUNE

4535

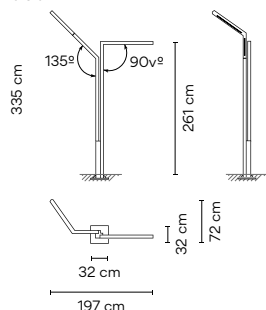

Light Source

3 x LED MODULE 24V 15W.
LED 2700 K. CRI >80. 1200 lm. 80 lm/W.
Driver Constant Voltage 24V.
100-277V. 50/60Hz.

Materials

Body: Steel.
Lid: Steel.
Diffuser: Polycarbonate.

Packaging

1 Box.
0,37 x 0,37 x 2,61 m.
Vol. 0,3570 m³
Gross weight 46,4 Kg.
Net weight 41,76 Kg.

4535 29 /10 Brown D1
(S 8005-Y50R)

4535 53 /10 Green M1
(S 6005-G80Y)



AVAILABLE FROM JUNE

4536

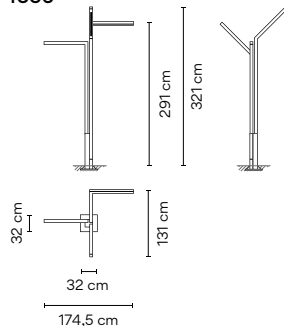

Light Source

4 x LED MODULE 24V 15W.
LED 2700 K. CRI >80. 4800 lm. 80 lm/W.
Driver Constant Voltage 24V.
100-277V. 50/60Hz.

Materials

Body: Steel.
Lid: Steel.
Diffuser: Polycarbonate.

Packaging

1 Box.
0,40 x 0,44 x 2,64 m.
Vol. 0,4646 m³
Gross weight 55,4 Kg.
Net weight 49,86 Kg.

4536 29 /10 Brown D1
(S 8005-Y50R)

4536 53 /10 Green M1
(S 6005-G80Y)



AVAILABLE FROM JUNE

Brisa

Design by Lievore, Altherr, Molina

Inspired by the forest blue bell flower, Brisa adds a nature-inspired accent to any outdoor space. Its long, slender stem is topped with a hanging, conical shade and features adjustable, revolving arms.



Outdoor

4625

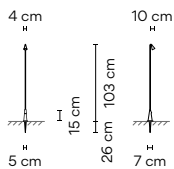

Light Source



1 x LED 2,1W 700mA.
LED 2700 K. CRI >80. 199 lm. 95 lm/W.
Driver Constant Current 700mA.
100-240V. 50/60Hz.

Spike. Surface.

Personalization options available

- LED 3000 K / 4000 K.
Min. quantity, upcharge and extra lead time apply.

Materials

Shade and Base: Aluminum.
Disc: Stainless steel.
Vertical tube: Steel.

Packaging

1 Box.
0,13 x 0,19 x 1,26 m.
Vol. 0,0311 m³.
Gross weight 1,8 Kg.
Net weight 1,3 Kg.

4625 07 /10 Khaki
(RAL 7039)

4625 54 /10 Oxide
(RAL 8014)

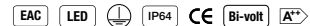

4630

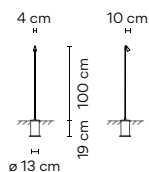

Light Source



1 x LED 2,1W 700mA.
LED 2700 K. CRI >80. 199 lm. 95 lm/W.
Driver Constant Current 700mA.
100-240V. 50/60Hz.

Built-in.

Personalization options available

- LED 3000 K / 4000 K.
Min. quantity, upcharge and extra lead time apply.

Materials

Shade and Base: Aluminum.
Disc: Stainless steel.
Vertical tube: Steel.

Packaging

1 Box.
0,17 x 0,18 x 1,22 m.
Vol. 0,0373 m³.
Gross weight 2,6 Kg.
Net weight 2 Kg.

4630 07 /10 Khaki
(RAL 7039)

4630 54 /10 Oxide
(RAL 8014)



Brisa

4635

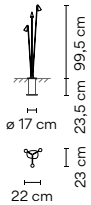

Light Source

3 x LED 2,1W 700mA.
LED 2700 K. CRI >80. 598 lm. 95 lm/W.
Driver Constant Current 700mA.
 100-240V. 50/60Hz.

Built-in.

Personalization options available
 - LED 3000 K / 4000 K.
 Min. quantity, upcharge and extra lead time apply.

Materials

Shade and Base: Aluminum.
 Disc: Stainless steel.
 Vertical tube: Steel.

Packaging

1 Box.
 0,39 x 1,11 x 0,37 m.
 Vol. 0,1601 m³.
 Gross weight 6,5 Kg.
 Net weight 5,85 Kg.

4635 07 /10 Khaki
 (RAL 7039)

4635 54 /10 Oxide
 (RAL 8014)



4640

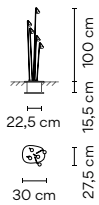

Light Source

5 x LED 2,1W 700mA.
LED 2700 K. CRI >80. 996 lm. 95 lm/W.
Driver Constant Current 700mA.
 100-240V. 50/60Hz.

Built-in.

Personalization options available
 - LED 3000 K / 4000 K.
 Min. quantity, upcharge and extra lead time apply.

Materials

Shade and Base: Aluminum.
 Disc: Stainless steel.
 Vertical tube: Steel.

Packaging

1 Box.
 0,36 x 0,40 x 1,10 m.
 Vol. 0,1584 m³.
 Gross weight 6 Kg.
 Net weight 4 Kg.

4640 07 /10 Khaki
 (RAL 7039)

4640 54 /10 Oxide
 (RAL 8014)



Meridiano

Design by Jordi Vilardell & Meritxell Vidal

Meridiano features a grid of steel slots through which LED light radiates outwards in a dramatic sunburst pattern. Topped with foam, it doubles as a seat or side table, its airy architecture integrating easily into outdoor spaces.



Outdoor

4710

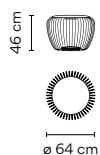

Light Source

 1 x LED 9W 350mA.
LED 2700 K. CRI >80. 1041 lm. 116 lm/W.
Driver Constant Current 350mA.
100-240V. 50/60Hz.

Materials

Seat: Polyurethane foam.
Rods: Steel.
Arm: Steel.
Diffuser: Glass.

Packaging

1 Box.
0,57 x 0,66 x 0,66 m.
Vol. 0,2483 m³.
Gross weight 18,2 Kg.
Net weight 15,6 Kg.

4710 07 /10 Khaki
(RAL 7006)

4710 58 /10 Off-white
(PANTONE WARM GRAY 2U)

4710 62 /10 Green
(RAL 6021)



4715

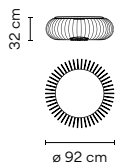

Light Source

 1 x LED 9W 350mA.
LED 2700 K. CRI >80. 1041 lm. 116 lm/W.
Driver Constant Current 350mA.
100-240V. 50/60Hz.

Materials

Seat: Polyurethane foam.
Rods: Steel.
Arm: Steel.
Diffuser: Glass.

Packaging

1 Box.
0,43 x 0,94 x 0,94 m.
Vol. 0,38 m³.
Gross weight 20,1 Kg.
Net weight 16,7 Kg.

4715 07 /10 Khaki
(RAL 7006)

4715 58 /10 Off-white
(PANTONE WARM GRAY 2U)

4715 62 /10 Green
(RAL 6021)



4720

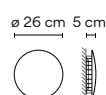

Light Source

 1 x LED 9W 350mA.
LED 2700 K. CRI >80. 1041 lm. 116 lm/W.
Driver Constant Current 350mA.
100-240V. 50/60Hz.

Materials

Base: Steel.

Packaging

1 Box.
0,106 x 0,310 x 0,310 m.
Vol. 0,102 m³.
Gross weight 1,5 Kg.
Net weight 1 Kg.

4720 07 /10 Khaki
(RAL 7006)

4720 58 /10 Off-white
(PANTONE WARM GRAY 2U)

4720 62 /10 Green
(RAL 6021)



June

Design by Ana Mir + Emili Padrós (emiliana design studio)

Inspired by traditional lanterns, June recall garlands festooned throughout an outdoor space. Its moon-like spheres cast a warm, ambient glow.

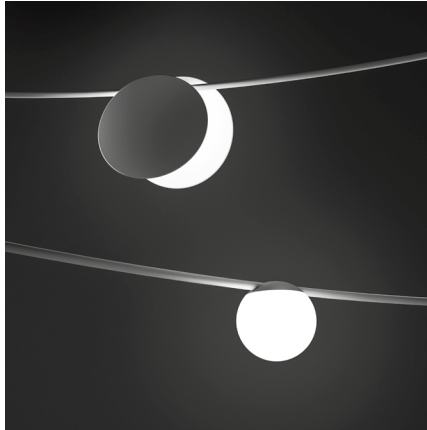

Outdoor

4730

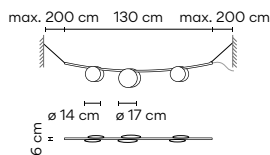

Light Source



3 x LED 1W 350mA.
LED 2700 K. CRI >80. 365,2 lm. 121,7 lm/W.
Driver Constant Current 350mA.
100-240V. 50/60Hz.

Materials

Diffuser: PVC + UV.
Tubes: Steel.

Packaging

1 Box.
1,5 x 0,4 x 0,4 m.
Vol. 0,24 m³.
Gross weight 5 Kg.
Net weight 3 Kg.

4730 54 /10 Brown
(Pantone Black U).



4735

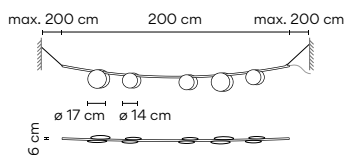

Light Source



5 x LED 1W 350mA.
LED 2700 K. CRI >80. 608,6 lm. 121,7 lm/W.
Driver Constant Current 350mA.
100-240V. 50/60Hz.

Materials

Diffuser: PVC + UV.
Tubes: Steel.

Packaging

1 Box.
2,3 x 0,4 x 0,4 m.
Vol. 0,368 m³.
Gross weight 7 Kg.
Net weight 5 Kg.

4735 54 /10 Brown
(Pantone Black U).



4745

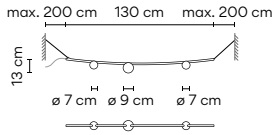

Light Source

 3 x LED 1W 350mA.
LED 2700 K. CRI >80. 365,2 lm. 121,7 lm/W.
Driver Constant Current 350mA.
 100-240V. 50/60Hz.

Materials

Diffuser:
Opal blown glass.
Tubes: Steel.

4745 54 /10 Brown
 (Pantone Black U).



Packaging

1 Box.
 1,5 x 0,4 x 0,4 m.
 Vol. 0,24 m³.
 Gross weight 5,5 Kg.
 Net weight 3,5 Kg.

4750

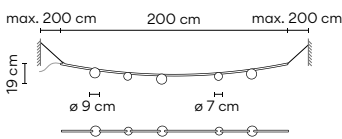

Light Source

 5 x LED 1W 350mA.
LED 2700 K. CRI >80. 608,6 lm. 121,7 lm/W.
Driver Constant Current 350mA.
 100-240V. 50/60Hz.

Materials

Diffuser:
Opal blown glass.
Tubes: Steel.

4750 54 /10 Brown
 (Pantone Black U).



Packaging

1 Box.
 2,3 x 0,4 x 0,4 m.
 Vol. 0,24 m³.
 Gross weight 7 Kg.
 Net weight 5 Kg.

4765

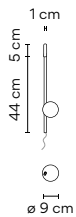

Light Source

 1 x LED 1W 350mA.
LED 2700 K. CRI >80. 121,7 lm. 121,7 lm/W.
Driver Constant Current 350mA.
 100-240V. 50/60Hz.

Materials

Diffuser:
Opal blown glass.
Tubes: Steel.

4765 54 /10 Brown
 (Pantone Black U).



Packaging

1 Box.
 0,8 x 0,4 x 0,4 m.
 Vol. 0,128 m³.
 Gross weight 3 Kg.
 Net weight 2 Kg.

Electric cable 9 m.

4770

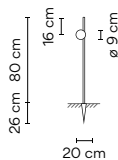

Light Source

 1 x LED 1W 350mA.
LED 2700 K. CRI >80. 121,7 lm. 121,7 lm/W.
Driver Constant Current 350mA.
 100-240V. 50/60Hz.

Materials

Diffuser:
Opal blown glass.
Tubes: Steel.

4770 54 /10 Brown
 (Pantone Black U).



Packaging

1 Box.
 1 x 0,4 x 0,4 m.
 Vol. 0,016 m³.
 Gross weight 5 Kg.
 Net weight 3 Kg.

Electric cable 3 m.

4775

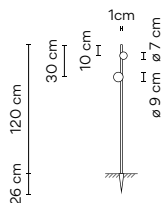

Light Source

 2 x LED 1W 350mA.
LED 2700 K. CRI >80. 243,4 lm. 121,7 lm/W.
Driver Constant Current 350mA.
 100-240V. 50/60Hz.

Materials

Diffuser:
Opal blown glass.
Tubes: Steel.

4775 54 /10 Brown
 (Pantone Black U).



Packaging

1 Box.
 1,5 x 0,4 x 0,4 m.
 Vol. 0,24 m³.
 Gross weight 6 Kg.
 Net weight 4 Kg.

Electric cable 3 m.

4780

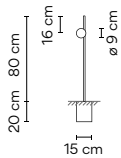

Light Source



1 x LED 1W 350mA.
LED 2700 K. CRI >80. 121,7 lm. 121,7 lm/W.
Driver Constant Current 350mA.
100-240V. 50/60Hz.

Electric cable 4 m.

Materials

Diffuser:
Opal blown glass.
Tubes: Steel.

Packaging

1 Box.
1 x 0,4 x 0,4 m.
Vol. 0,16 m³.
Gross weight 5 Kg.
Net weight 3 Kg.

4780 54 /10 Brown
(Pantone Black U).



4785

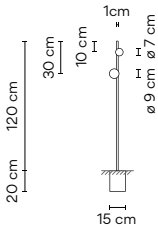

Light Source



2 x LED 1W 350mA.
LED 2700 K. CRI >80. 243,4 lm. 121,7 lm/W.
Driver Constant Current 350mA.
100-240V. 50/60Hz.

Electric cable 4 m.

Materials

Diffuser:
Opal blown glass.
Tubes: Steel.

Packaging

1 Box.
1,5 x 0,4 x 0,4 m.
Vol. 0,24 m³.
Gross weight 6 Kg.
Net weight 4 Kg.

4785 54 /10 Brown
(Pantone Black U).



4790

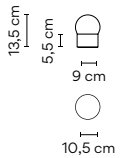

Light Source



1 x LED 1W 350mA.
LED 2700 K. CRI >80. 121,7 lm. 121,7 lm/W.
Driver Constant Current 350mA.
110-240V. 50/60Hz.

Dimmer switch on the base.
3-step dimming.

Charge by removable cable.
Battery life: from 6 to 18 hours
(depending on intensity).

Product with IP20. Should not be used outdoors in rain or very humid environments, with water condensation. After use, it should be stored inside.

Materials

Diffuser:
Opal blown glass.
Body: Aluminum.

Packaging

1 Box.
0,3 x 0,3 x 0,3 m.
Vol. 0,027 m³.
Gross weight 2 Kg.
Net weight 1 Kg.

4790 54 /15 Brown
(Pantone Black U).



4795

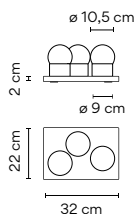

Light Source



3 x LED 1W 350mA.
LED 2700 K. CRI >80. 365,2 lm. 121,7 lm/W.
Driver Constant Current 350mA.
110-240V. 50/60Hz.

Dimmer switch on the base.
3-step dimming.

Tray with 3 units. Charge by contact.
Battery life: from 6 to 18 hours
(depending on intensity).

Product with IP20. Should not be used outdoors in rain or very humid environments, with water condensation. After use, it should be stored inside.

Materials

Diffuser:
Opal blown glass.
Body: Aluminum.

Packaging

1 Box.
0,5 x 0,5 x 0,3 m.
Vol. 0,075 m³.
Gross weight 4,90 Kg.
Net weight 3,60 Kg.

4795 54 /15 Brown
(Pantone Black U).



Bamboo

Design by Antoni Arola & Enric Rodríguez

Bamboo's lean, natural form perfectly lends itself to an outdoor setting. Studded with LEDs, it seamlessly integrates with the landscape while adding a wash of light to walkways and common spaces.



Outdoor

4800

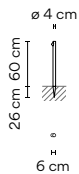

Light Source



1 x LED 2,1W 700mA.
LED 2700 K. CRI >80. 199 lm. 95 lm/W.
Driver Constant Current 700mA.
100-240V. 50/60Hz.

Surface.

Personalization options available

- LED 3000 K / 4000 K.
Min. quantity, upcharge and extra lead time apply.

Materials

Cane: Resin + fiberglass.
Diffuser: Methacrylate.

Packaging

2 Boxes.
Total Vol. 0,0480 m³.
Gross weight 7 Kg.
Net weight 5,5 Kg.

4800 07 /10 Khaki
(RAL 7006)

4800 54 /10 Oxide
(RAL 8017)

4800 58 /10 Off-white
(PANTONE WARM GRAY 2U)



4801

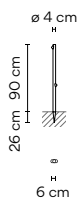

Light Source



2 x LED 2,1W 700mA.
LED 2700 K. CRI >80. 398,6 lm. 95 lm/W.
Driver Constant Current 700mA.
100-240V. 50/60Hz.

Surface.

Personalization options available

- LED 3000 K / 4000 K.
Min. quantity, upcharge and extra lead time apply.

Materials

Cane: Resin + fiberglass.
Diffuser: Methacrylate.

Packaging

2 Boxes.
Total Vol. 0,0470 m³.
Gross weight 8,5 Kg.
Net weight 6 Kg.

4801 07 /10 Khaki
(RAL 7006)

4801 54 /10 Oxide
(RAL 8017)

4801 58 /10 Off-white
(PANTONE WARM GRAY 2U)



4802

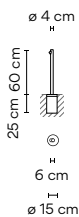

Light Source



1 x LED 2,1W 700mA.
LED 2700 K. CRI >80. 199 lm. 95 lm/W.
Driver Constant Current 700mA.
100-240V. 50/60Hz.

Built-in.

Personalization options available

- LED 3000 K / 4000 K.
Min. quantity, upcharge and extra lead time apply.

Materials

Cane: Resin + fiberglass.
Diffuser: Methacrylate.

Packaging

2 Boxes.
Total Vol. 0,0480 m³.
Gross weight 7 Kg.
Net weight 5,5 Kg.

4802 07 /10 Khaki
(RAL 7006)

4802 54 /10 Oxide
(RAL 8017)

4802 58 /10 Off-white
(PANTONE WARM GRAY 2U)



Bamboo

4803

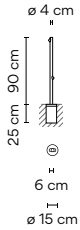

Light Source

2 x LED 2,1W 700mA.
LED 2700 K. CRI >80. 398,6 lm. 95 lm/W.
Driver Constant Current 700mA.
 100-240V. 50/60Hz.

Built-in.

Personalization options available

- LED 3000 K / 4000 K.
 Min. quantity, upcharge and extra lead time apply.

Materials

Cane: Resin + fiberglass.
 Diffuser: Methacrylate.

Packaging

2 Boxes.
 Total Vol. 0,0470 m³.
 Gross weight 8,5 Kg.
 Net weight 5,8 Kg.

4803 07 /10 Khaki
 (RAL 7006)

4803 54 /10 Oxide
 (RAL 8017)

4803 58 /10 Off-white
 (PANTONE WARM GRAY 2U)



4804

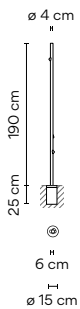

Light Source

3 x LED 2,1W 700mA.
LED 2700 K. CRI >80. 598lm. 95 lm/W.
Driver Constant Current 700mA.
 100-240V. 50/60Hz.

Built-in.

Personalization options available

- LED 3000 K / 4000 K.
 Min. quantity, upcharge and extra lead time apply.

Materials

Cane: Resin + fiberglass.
 Diffuser: Methacrylate.

Packaging

2 Boxes.
 Total Vol. 0,0480 m³.
 Gross weight 8 Kg.
 Net weight 6,5 Kg.

4804 07 /10 Khaki
 (RAL 7006)

4804 54 /10 Oxide
 (RAL 8017)

4804 58 /10 Off-white
 (PANTONE WARM GRAY 2U)



4805

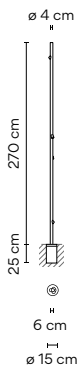

Light Source

4 x LED 2,1W 700mA.
LED 2700 K. CRI >80. 797 lm. 95 lm/W.
Driver Constant Current 700mA.
 100-240V. 50/60Hz.

Built-in.

Personalization options available

- LED 3000 K / 4000 K.
 Min. quantity, upcharge and extra lead time apply.

Materials

Cane: Resin + fiberglass.
 Diffuser: Methacrylate.

Packaging

2 Boxes.
 Total Vol. 0,0600 m³.
 Gross weight 9 Kg.
 Net weight 7 Kg.

4805 07 /10 Khaki
 (RAL 7006)

4805 54 /10 Oxide
 (RAL 8017)

4805 58 /10 Off-white
 (PANTONE WARM GRAY 2U)



4810

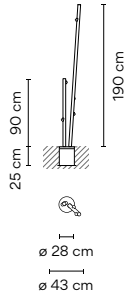

Light Source

5 x LED 2,1W 700mA.
LED 2700 K. CRI >80. 996,5 lm. 95 lm/W.
Driver Constant Current 700mA.
 100-240V. 50/60Hz.

Built-in.

Personalization options available

- LED 3000 K / 4000 K.
 Min. quantity, upcharge and extra lead time apply.

Materials

Cane: Resin + fiberglass.
 Diffuser: Methacrylate.

Packaging

3 Boxes.
 Total Vol. 0,1388 m³.
 Gross weight 15 Kg.
 Net weight 12,5 Kg.

4810 07 /10 Khaki
 (RAL 7006)

4810 54 /10 Oxide
 (RAL 8017)

4810 58 /10 Off-white
 (PANTONE WARM GRAY 2U)



Bamboo

4811

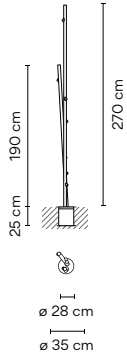

Light Source

7 x LED 2,1W 700mA.
LED 2700 K. CRI >80. 1395 lm. 95 lm/W.
Driver Constant Current 700mA.
100-240V. 50/60Hz.

Built-in.

Personalization options available
- LED 3000 K / 4000 K.
Min. quantity, upcharge and extra lead time apply.

Materials

Cane: Resin + fiberglass.
Diffuser: Methacrylate.

Packaging

3 Boxes.
Total Vol. 1,660 m³.
Gross weight 16,5 Kg.
Net weight 13 Kg.

4811 07 /10 Khaki
(RAL 7006)

4811 54 /10 Oxide
(RAL 8017)

4811 58 /10 Off-white
(PANTONE WARM GRAY 2U)



4812

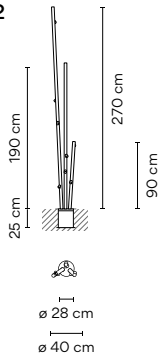

Light Source

9 x LED 2,1W 700mA.
LED 2700 K. CRI >80. 1794 lm. 95 lm/W.
Driver Constant Current 700mA.
100-240V. 50/60Hz.

Built-in.

Personalization options available
- LED 3000 K / 4000 K.
Min. quantity, upcharge and extra lead time apply.

Materials

Cane: Resin + fiberglass.
Diffuser: Methacrylate.

Packaging

4 Boxes.
Total Vol. 0,1854 m³.
Gross weight 21,6 Kg.
Net weight 19,44 Kg.

4812 07 /10 Khaki
(RAL 7006)

4812 54 /10 Oxide
(RAL 8017)

4812 58 /10 Off-white
(PANTONE WARM GRAY 2U)



4815

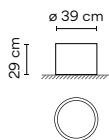

Surface installation accessory.
For ref. 4810. 4811. 4812.

Materials

Base: Polymer concrete.

Packaging

1 Box.
0,40 x 0,50 x 0,50 m.
Vol. 0,1000 m³.
Gross weight 39 Kg.
Net weight 35 Kg.

4815 18 Polymer concrete
(RAL 7035)

4820

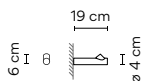

Light Source

1 x LED 2,1W 700mA.
LED 2700 K. CRI >80. 199 lm. 95 lm/W.
Driver Constant Current 700mA.
100-240V. 50/60Hz.

Surface.

Personalization options available
- LED 3000 K / 4000 K.
Min. quantity, upcharge and extra lead time apply.

Materials

Cane: Resin + fiberglass.
Diffuser: Methacrylate.

Packaging

1 Box.
0,25 x 0,10 x 0,10 m.
Vol. 0,0025 m³.
Gross weight 2 Kg.
Net weight 1 Kg.

4820 07 /10 Khaki
(RAL 7006)

4820 54 /10 Oxide
(RAL 8017)

4820 58 /10 Off-white
(PANTONE WARM GRAY 2U)



Duo

Design by Ramos & Bassols

Natural warmth. Simple volumes with a sculptural quality, easily integrated with the architecture of the ceilings where they are fitted allowing the lights to become focal points without being suspended.

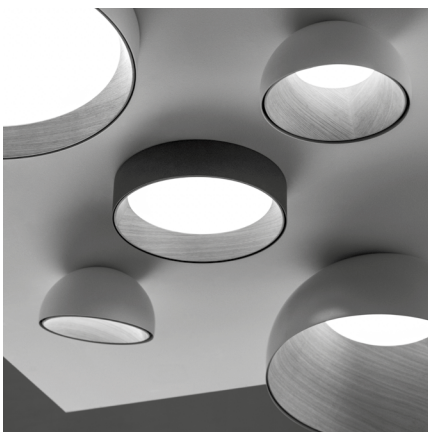

Ceiling

4870

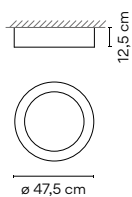

Light Source



 1 x LED PLATE 26,5W. 700mA.
 / **1A:**
 LED 2700 K. CRI >90. 1458 lm. 55 lm/W.
 / **4A:**
 LED 4000 K. CRI >80. 1237 lm. 46,68 lm/W.
Driver Constant current 700mA.
 110-240V. 50/60Hz.
Dimming: DALI, 1-10V, Push.

Personalization options available

- Finish customization.
 (Available options: Vibia color palette).
 - Dimming: Casambi.
 Min. quantity, upcharge and extra lead time apply.

Materials

Diffuser: Polycarbonate.
 Main Body: Aluminum.
 Inner structure: Oak wood.

Packaging

1 Box.
 0,56 x 0,56 x 0,26 m.
 Vol. 0,0815 m³.
 Gross weight 7 Kg.
 Net weight 6 Kg.

4870 18 /1A Graphite
(Adapta RF9913WX)

4870 18 /4A Graphite
(Adapta RF9913WX)

4870 58 /1A Cream
(RAL 7044)

4870 58 /4A Cream
(RAL 7044)

4870 93 /1A White
(RAL 9016)

4870 93 /4A White
(RAL 9016)







4872

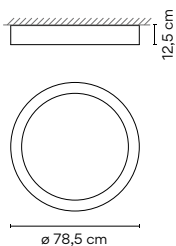

Light Source



 1 x LED PLATE 50W. 750mA.
 / **1A:**
 LED 2700 K. CRI >90. 3967,93 lm. 79,35 lm/W.
 / **4A:**
 LED 4000 K. CRI >80. 4648 lm. 92,66 lm/W.
Driver Constant current 750mA.
 110-240V. 50/60Hz.
Dimming: DALI, 1-10V, Push.

Personalization options available

- Finish customization.
 (Available options: Vibia color palette).
 - Dimming: Casambi.
 Min. quantity, upcharge and extra lead time apply.

Materials

Diffuser: Polycarbonate.
 Main Body: Aluminum.
 Inner structure: Oak wood.

Packaging

1 Box.
 0,9 x 0,9 x 0,25 m.
 Vol. 0,2025 m³.
 Gross weight 19 Kg.
 Net weight 17 Kg.

4872 18 /1A Graphite
(Adapta RF9913WX)

4872 18 /4A Graphite
(Adapta RF9913WX)

4872 58 /1A Cream
(RAL 7044)

4872 58 /4A Cream
(RAL 7044)

4872 93 /1A White
(RAL 9016)

4872 93 /4A White
(RAL 9016)







4874

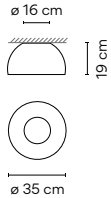

Light Source

 1 x LED PLATE 12W. 350mA.
/ 1B:
 LED 2700 K. CRI >80. 1100 lm. 91,67 lm/W.
/ 4B:
 LED 4000 K. CRI >80. 1194,5 lm. 99,54 lm/W.
Driver Constant current 350mA.
 110-240V. 50/60Hz.
Dimming: 1-10V, Push.

Personalization options available

- Finish customization.
 (Available options: Vibia color palette).
 - Dimming: DALI, Casambi.
 Min. quantity, upcharge and extra lead time apply.

Materials

Diffuser: Polycarbonate.
 Main Body: Aluminum.
 Inner structure: Oak wood.

Packaging

1 Box.
 0,44 x 0,44 x 0,35 m.
 Vol. 0,0678 m³.
 Gross weight 5 Kg.
 Net weight 4 Kg.

4874 18 /1B Graphite
 (Adapta RF9913WX)

4874 18 /4B Graphite
 (Adapta RF9913WX)

4874 58 /1B Cream
 (RAL 7044)

4874 58 /4B Cream
 (RAL 7044)

4874 93 /1B White
 (RAL 9016)

4874 93 /4B White
 (RAL 9016)



4876

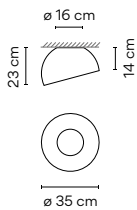

Light Source

 1 x LED PLATE 12W. 350mA.
/ 1B:
 LED 2700 K. CRI >80. 1100 lm. 91,67 lm/W.
/ 4B:
 LED 4000 K. CRI >80. 1194,5 lm. 99,54 lm/W.
Driver Constant current 350mA.
 110-240V. 50/60Hz.
Dimming: 1-10V, Push.

Personalization options available

- Finish customization.
 (Available options: Vibia color palette).
 - Dimming: DALI, Casambi.
 Min. quantity, upcharge and extra lead time apply.

Materials

Diffuser: Polycarbonate.
 Main Body: Aluminum.
 Inner structure: Oak wood.

Packaging

1 Box.
 0,44 x 0,44 x 0,35 m.
 Vol. 0,0678 m³.
 Gross weight 5 Kg.
 Net weight 4 Kg.

4876 18 /1B Graphite
 (Adapta RF9913WX)

4876 18 /4B Graphite
 (Adapta RF9913WX)

4876 58 /1B Cream
 (RAL 7044)

4876 58 /4B Cream
 (RAL 7044)

4876 93 /1B White
 (RAL 9016)

4876 93 /4B White
 (RAL 9016)



4878

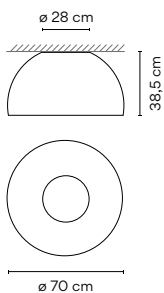

Light Source

 1 x LED PLATE 26,5W. 700mA.
/ 1A:
 LED 2700 K. CRI >90. 1458 lm. 55 lm/W.
/ 4A:
 LED 4000 K. CRI >80. 1237 lm. 46,68 lm/W.
Driver Constant current 700mA.
 110-240V. 50/60Hz.
Dimming: DALI, 1-10V, Push.

Personalization options available

- Finish customization.
 (Available options: Vibia color palette).
 - Dimming: Casambi.
 Min. quantity, upcharge and extra lead time apply.

Materials

Diffuser: Polycarbonate.
 Main Body: Aluminum.
 Inner structure: Oak wood.

Packaging

1 Box.
 0,79 x 0,79 x 0,59 m.
 Vol. 0,3682 m³.
 Gross weight 16 Kg.
 Net weight 14 Kg.

4878 18 /1A Graphite
 (Adapta RF9913WX)

4878 18 /4A Graphite
 (Adapta RF9913WX)

4878 58 /1A Cream
 (RAL 7044)

4878 58 /4A Cream
 (RAL 7044)

4878 93 /1A White
 (RAL 9016)

4878 93 /4A White
 (RAL 9016)



4880

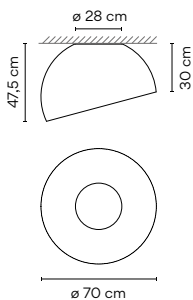

Light Source

 1 x LED PLATE 26,5W. 700mA.
/ 1A:
 LED 2700 K. CRI >90. 1458 lm. 55 lm/W.
/ 4A:
 LED 4000 K. CRI >80. 1237 lm. 46,68 lm/W.
Driver Constant current 700mA
 110-240V. 50/60Hz.
Dimming: DALI, 1-10V, Push.

Personalization options available

- Finish customization.
 (Available options: Vibia color palette).
 - Dimming: Casambi.
 Min. quantity, upcharge and extra lead time apply.

Materials

Diffuser: Polycarbonate.
 Main Body: Aluminum.
 Inner structure: Oak wood.

Packaging

1 Box.
 0,79 x 0,79 x 0,59 m.
 Vol. 0,3682 m³.
 Gross weight 16 Kg.
 Net weight 14 Kg.

4880 18 /1A Graphite
 (Adapta RF9913WX)

4880 18 /4A Graphite
 (Adapta RF9913WX)

4880 58 /1A Cream
 (RAL 7044)

4880 58 /4A Cream
 (RAL 7044)

4880 93 /1A White
 (RAL 9016)

4880 93 /4A White
 (RAL 9016)



Warm

Design by Ramos & Bassols

Offering a contemporary take on a timeless design, Warm features a generously sized, classic drum shade, with a careful selected color palette that provides a contemporary touch.

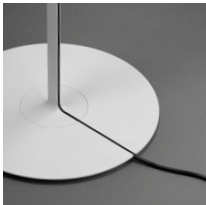

Table

4895

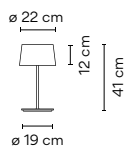

Light Source



3 x LED G9 230V 3W 2800K MEGAMAN.

On/off switch on the cable.
Electric cable 2 m.

Materials

Shade: Screen.
Diffuser: Methacrylate.
Rod: Aluminum.
Base: Steel.

Packaging

2 Boxes.
Total Vol. 0,0390 m³.
Gross weight 2,9 Kg.
Net weight 1,3 Kg.

4895 10 White
(NCS S 0300-N)



4896

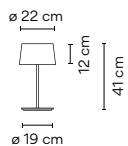

Light Source



3 x LED G9 230V 3W 2800K MEGAMAN.

On/off switch on the cable.
Electric cable 2 m.

Personalization options available

- Finish customization.
(Available options: Vibia color palette).
Min. quantity, upcharge and extra lead time apply.

Materials

Shade: Aluminum.
Diffuser: Methacrylate.
Rod: Aluminum.
Base: Steel.

Packaging

2 Boxes.
Total Vol. 0,0390 m³.
Gross weight 2,9 Kg.
Net weight 2 Kg.

4896 10 White
(NCS S 0300-N).

4896 25 Beige D1
(NCS S 4005-Y50R).

4896 28 Brown M1
(NCS S 4020-Y60R).

4896 56 Green D1
(NCS S 7010-G30Y).



4900

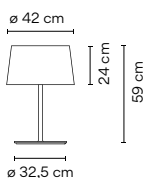

Light Source

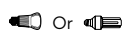

3 x MASTER LED Bulb E27 230V 15W.
Or
3 x COMPACT FLUORESCENT
E27 230V 20W Max.

On/off switch on the cable.
Electric cable 2 m.

Materials

Shade: Screen.
Diffuser: Methacrylate.
Rod: Aluminum.
Base: Steel.

Packaging

2 Boxes.
Total Vol. 0,2153 m³.
Gross weight 4,3 Kg.
Net weight 3,8 Kg.

4900 10 White
(NCS S 0300-N)



Warm

4901

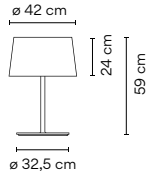

Light Source

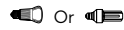

3 x MASTER LEDBulb E27 230V 15W.
Or
3 x COMPACT FLUORESCENT
E27 230V 20W Max.

On/off switch on the cable.
Electrical connection 2 m.

Personalization options available

- Finish customization.
(Available options: Vibia color palette).
Min. quantity, upcharge and extra lead
time apply.

Materials

Shade: Aluminum.
Diffuser: Methacrylate.
Rod: Aluminum.
Base: Steel.

Packaging

2 Boxes.
Total Vol. 0,2153 m³.
Gross weight 4,8 Kg.
Net weight 4,3 Kg.

4901 10 White
(NCS S 0300-N).

4901 25 Beige D1
(NCS S 4005-Y50R).

4901 28 Brown M1
(NCS S 4020-Y60R).

4901 56 Green D1
(NCS S 7010-G30Y).



Floor

4905

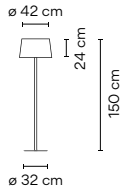

Light Source

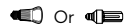

3 x MASTER LEDBulb E27 230V 15W.
Or
3 x COMPACT FLUORESCENT
E27 230V 20W Max.

On/off switch on the cable.
Electric cable 2,5 m.

Materials

Shade: Screen.
Diffuser: Methacrylate.
Rod: Aluminum.
Base: Steel.

Packaging

2 Boxes.
Total Vol. 0,3426 m³.
Gross weight 10,2 Kg.
Net weight 6,3 Kg.

4905 10 White
(NCS S 0300-N).



4906

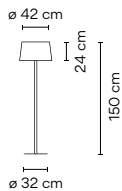

Light Source

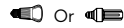

3 x MASTER LEDBulb E27 230V 15W.
Or
3 x COMPACT FLUORESCENT
E27 230V 20W Max.

On/off switch on the cable.
Electric cable 2,5 m.

Personalization options available

- Finish customization.
(Available options: Vibia color palette).
Min. quantity, upcharge and extra lead
time apply.

Materials

Shade: Aluminum.
Diffuser: Methacrylate.
Rod: Aluminum.
Base: Steel.

Packaging

2 Boxes.
Total Vol. 0,3426 m³.
Gross weight 10,7 Kg.
Net weight 6,8 Kg.

4906 10 White
(NCS S 0300-N).

4906 25 Beige D1
(NCS S 4005-Y50R).

4906 28 Brown M1
(NCS S 4020-Y60R).

4906 56 Green D1
(NCS S 7010-G30Y).



Pendants

4925

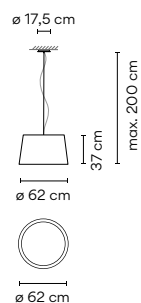

Light Source

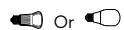

4 x MASTER LEDBulb E27 230V 15W.
Or
4 x COMPACT FLUORESCENT
E27 230V 20W Max.
(Philips Softone-Doble Envelope).

Personalization options available

- Extra cable length.
Min. quantity, upcharge and extra lead
time apply.

Materials

Shade: Screen.
Canopy: Steel.
Diffuser: Methacrylate.

Packaging

1 Box.
0,68 x 0,68 x 0,39 m.
Vol. 0,18 m³.
Gross weight 7,7 Kg.
Net weight 3,9 Kg.

4925 10 White
(NCS S 0300-N).



Warm

4926

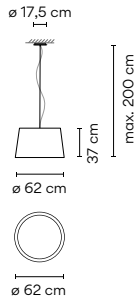

Light Source

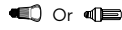

4 x MASTER LEDBulb E27 230V 15W.
Or
4 x COMPACT FLUORESCENT
E27 230V 20W Max.

Personalization options available

- Finish customization.
(Available options: Vibia color palette).
- Extra cable length.
Min. quantity, upcharge and extra lead time apply.

Materials

Shade: Aluminum.
Canopy: Steel.
Diffuser: Methacrylate.

Packaging

1 Box.
0,77 x 0,77 x 0,50 m.
Vol. 0,2965 m³.
Gross weight 8,9 Kg.
Net weight 5,1 Kg.

4926 10 White

(NCS S 0300-N).

4926 25 Beige D1

(NCS S 4005-Y50R).

4926 28 Brown M1

(NCS S 4020-Y60R).

4926 56 Green D1

(NCS S 7010-G30Y).



4930

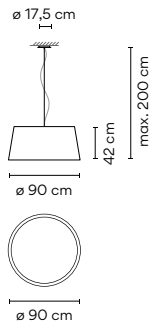

Light Source

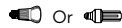

4 x MASTER LEDBulb E27 230V 15W.
Or
4 x COMPACT FLUORESCENT
E27 230V 20W Max.

Personalization options available

- Extra cable length.
Min. quantity, upcharge and extra lead time apply.

Materials

Shade: Screen.
Canopy: Steel.
Diffuser: Methacrylate.

Packaging

1 Box.
0,77 x 0,77 x 0,50 m.
Vol. 0,2965 m³.
Gross weight 8,9 Kg.
Net weight 7,7 Kg.

4930 10 White

(NCS S 0300-N)



4935

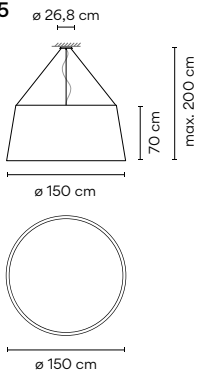

Light Source

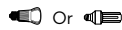

4 x MASTER LEDBulb E27 230V 15W.
Or
4 x COMPACT FLUORESCENT
E27 230V 20W Max.

Personalization options available

- Extra cable length.
Min. quantity, upcharge and extra lead time apply.

Materials

Shade: Screen.
Canopy: Steel.
Diffuser: Methacrylate.

Packaging

1 Box.
1,60 x 1,60 x 0,75 m.
Vol. 1,9200 m³.
Gross weight 28,1 Kg.
Net weight 20,1 Kg.

4935 10 White

(NCS S 0300-N)



Join

Design by Jordi Vilardell

Join is marked by its unique glass-within-a-glass design. Crafted of precision glass, it features a cylinder-shaped structure which houses an interior glass shade.



Table

5066



Light Source



1 x G9 230V 48W Eco.

On/off switch on the cable.
Electric cable 2 m.

Materials

Lamp holder: Ceramic.
Top: Brass.

Packaging

1 Box.
0,29 x 0,38 x 0,38 m.
Vol. 0,0419 m³.
Gross weight 2,12 Kg.
Net weight 0,9 Kg.

5066 01 Borosilicate glass



5068

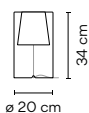

Light Source



1 x G9 230V 48W Eco.

On/off switch on the cable.
Electric cable 2 m.

Materials

Lamp holder: Ceramic.
Top: Brass.

Packaging

1 Box.
0,55 x 0,32 x 0,32 m.
Vol. 0,0563 m³.
Gross weight 6,4 Kg.
Net weight 5,2 Kg.

5068 01 Blown-glass



Balance

Design by Jordi Vilardell

Balance features a classic drum shade cantilevered from its column. Adjusting a small pull cord on the diffuser activates the fixture's counterweight system, enabling it to move to the right or left, or up or down-all the while remaining parallel to the floor.



Floor

<p>5189</p>	<p>Light Source</p> <p>●</p> <p>3 x E27 230V 70W Eco. Dimming: TRIAC.</p> <p>Dimmer on the cable. 3 m.</p>	<p>Materials</p> <p>Vertical tube: Aluminum. Base: Steel. Arm: Inox. Shade: Grey fabric.</p> <p>Packaging</p> <p>3 Boxes. Total Vol. 0,3472 m³. Gross weight 53,8 Kg. Net weight 49,5 Kg.</p>	<p>5189 01 Chrome (Metallic finish)</p> <p>5189 18 Graphite (RAL 7016)</p> <p>5189 30 Nickel (Metallic finish)</p> <p>EAC IP20 CE Dimmer</p>
<p>5190</p>	<p>Light Source</p> <p>●</p> <p>3 x E27 230V 70W Eco. Dimming: TRIAC.</p> <p>Dimmer on the cable. 3 m.</p>	<p>Materials</p> <p>Vertical tube: Aluminum. Base: Steel. Arm: Inox. Shade: Cotton.</p> <p>Packaging</p> <p>3 Boxes. Total Vol. 0,3472 m³. Gross weight 53,8 Kg. Net weight 49,5 Kg.</p>	<p>5190 01 Chrome (Metallic finish)</p> <p>5190 30 Nickel (Metallic finish)</p> <p>EAC IP20 CE Dimmer</p>
<p>5191</p>	<p>Light Source</p> <p>●</p> <p>3 x E27 230V 70W Eco. Dimming: TRIAC.</p> <p>Dimmer on the cable. 3 m.</p>	<p>Materials</p> <p>Vertical tube: Aluminum. Base: Steel. Arm: Inox. Shade: Cotton.</p> <p>Packaging</p> <p>3 Boxes. Total Vol. 0,3472 m³. Gross weight 53,4 Kg. Net weight 49,1 Kg.</p>	<p>5191 01 Chrome (Metallic finish)</p> <p>5191 30 Nickel (Metallic finish)</p> <p>EAC IP20 CE Dimmer</p>
<p>5192</p>	<p>Light Source</p> <p>●</p> <p>3 x E27 230V 70W Eco. Dimming: TRIAC.</p> <p>Dimmer on the cable. 3 m.</p>	<p>Materials</p> <p>Vertical tube: Aluminum. Base: Steel. Arm: Inox. Shade: Grey fabric.</p> <p>Packaging</p> <p>3 Boxes. Total Vol. 0,3472 m³. Gross weight 53,4 Kg. Net weight 49,1 Kg.</p>	<p>5192 01 Chrome (Metallic finish)</p> <p>5192 18 Graphite (RAL 7016)</p> <p>5192 30 Nickel (Metallic finish)</p> <p>EAC IP20 CE Dimmer</p>

Link XXL

Design by Ramón Esteve

Link XXL light features an assortment of cubic volumes that appear integrated into the architecture of the ceiling. The modular panels allow for customisable, geometric compositions, producing sprawling ceiling sculptures and a unique lighting effect.



Create your product configuration quickly and easily at vibia.com

Go to vibia.com and discover the quickest, most effective way to configure a unique Link XXL design.

5351 x 1, 5356 x 1, 5361 x 1



5351 x 1, 5356 x 1, 5361 x 1, 5366 x 1



5351 x 2, 5356 x 2, 5361 x 1, 5366 x 1



5351 x 2, 5356 x 2, 5361 x 2, 5366 x 2

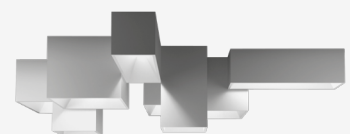

Ceiling

5351

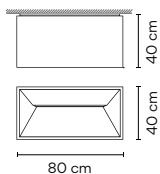

Light Source

2 x LED STRIP 11,8W. 500mA.
LED 4000 K. CRI >80. 2532 lm. 109 lm/W.
Driver Constant Current 500mA.
110-240V. 50/60Hz.
Dimming: DALI, 1-10V.

A maximum of 25 modules can be connected to a single connection point. For bigger compositions, check connection system.

Personalization options available

- Configuration layout at vibia.com
- Finish customization.
(Available options: Vibia color palette).

Min. quantity, upcharge and extra lead time apply.

Materials

Body: Polyurethane foam.
Diffuser: Polycarbonate.

Packaging

1 Box.
0,546 x 0,908 x 0,508 m.
Vol. 0,2519 m³.
Gross weight 19,6 Kg.
Net weight 17,16 Kg.

5351 03 White
(RAL 9010)

5351 18 Graphite
(RAL 7016)

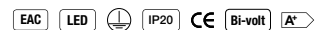

5356

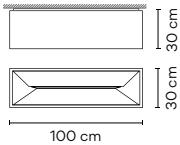

Light Source

2 x LED STRIP 11,8W. 500mA.
LED 4000 K. CRI >80. 2532 lm. 109 lm/W.
Driver Constant Current 500mA.
 110-240V. 50/60Hz.
Dimming: DALI, 1-10V.

A maximum of 25 modules can be connected to a single connection point. For bigger compositions, check connection system.

Personalization options available

- Configuration layout at vibia.com
 - Finish customization.
 (Available options: Vibia color palette).
- Min. quantity, upcharge and extra lead time apply.

Materials

Body: Polyurethane foam.
 Diffuser: Polycarbonate.

Packaging

1 Box.
 0,446 x 1,108 x 0,408 m.
 Vol. 0,2016 m³.
 Gross weight 16,4 Kg.
 Net weight 14,2 Kg.

5356 03 White
 (RAL 9010)

5356 18 Graphite
 (RAL 7016)



5361

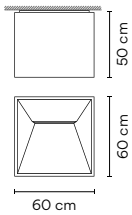

Light Source

2 x LED STRIP 11,8W. 500mA.
LED 4000 K. CRI >80. 2532 lm. 109 lm/W.
Driver Constant Current 500mA.
 110-240V. 50/60Hz.
Dimming: DALI, 1-10V.

A maximum of 25 modules can be connected to a single connection point. For bigger compositions, check connection system.

Personalization options available

- Configuration layout at vibia.com
 - Finish customization.
 (Available options: Vibia color palette).
- Min. quantity, upcharge and extra lead time apply.

Materials

Body: Polyurethane foam.
 Diffuser: Polycarbonate.

Packaging

1 Box.
 0,646 x 0,708 x 0,708 m.
 Vol. 0,3238 m³.
 Gross weight 24 Kg.
 Net weight 21,8 Kg.

5361 03 White
 (RAL 9010)

5361 18 Graphite
 (RAL 7016)



5366

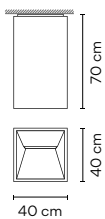

Light Source

2 x LED STRIP 11,8W. 500mA.
LED 4000 K. CRI >80. 2532 lm. 109 lm/W.
Driver Constant Current 500mA.
 110-240V. 50/60Hz.
Dimming: DALI, 1-10V.

A maximum of 25 modules can be connected to a single connection point. For bigger compositions, check connection system.

Personalization options available

- Configuration layout at vibia.com
 - Finish customization.
 (Available options: Vibia color palette).
- Min. quantity, upcharge and extra lead time apply.

Materials

Body: Polyurethane foam.
 Diffuser: Polycarbonate.

Packaging

1 Box.
 0,516 x 0,858 x 0,508 m.
 Vol. 0,2249 m³.
 Gross weight 19,1 Kg.
 Net weight 17,9 Kg.

5366 03 White
 (RAL 9010)

5366 18 Graphite
 (RAL 7016)



Link

Design by Ramón Esteve

Cubic volumes with different sizes and heights to offer a range of geometries perfectly fitting into the architecture of the ceiling.



Ceiling

5373

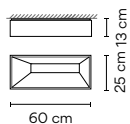

Light Source



 2 x 2G11 230V 24W.
 2 x 2G11 230V 18W.

Personalization options available
 - Configuration layout at vibia.com
 - Finish customization.
 (Available options: Vibia color palette).
 Min. quantity, upcharge and extra lead time apply.

Materials

Box: Aluminum.
Diffuser: Methacrylate.

Packaging

1 Box.
0,27 x 0,60 x 0,60 m.
Vol. 0,0972 m³.
Gross weight 7,1 Kg.
Net weight 2,1 Kg.

5373 03 Gloss white
(RAL 9010).

5373 18 Gloss graphite
(RAL 7016).



5376

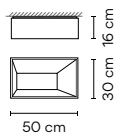

Light Source



 2 x 2G11 230V 24W.
 2 x 2G11 230V 18W.

Personalization options available
 - Configuration layout at vibia.com
 - Finish customization.
 (Available options: Vibia color palette).
 Min. quantity, upcharge and extra lead time apply.

Materials

Box: Aluminum.
Diffuser: Methacrylate.

Packaging

1 Box.
0,27 x 0,60 x 0,60 m.
Vol. 0,0972 m³.
Gross weight 7,1 Kg.
Net weight 5,2 Kg.

5376 03 Gloss white
(RAL 9010).

5376 18 Gloss graphite
(RAL 7016).



5379

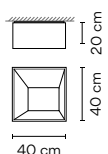

Light Source



 4 x 2G11 230V 24W.

Personalization options available
 - Configuration layout at vibia.com
 - Finish customization.
 (Available options: Vibia color palette).
 Min. quantity, upcharge and extra lead time apply.

Materials

Box: Aluminum.
Diffuser: Methacrylate.

Packaging

1 Box.
0,35 x 0,49 x 0,49 m.
Vol. 0,084 m³.
Gross weight 7,9 Kg.
Net weight 6 Kg.

5379 03 Gloss white
(RAL 9010).

5379 18 Gloss graphite
(RAL 7016).



5380

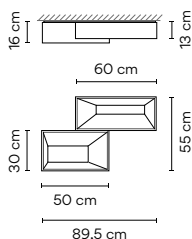

Light Source

4 x 2G11 230V 24W.
4 x 2G11 230V 18W.

Dimming: DALI, Push.

Dimmable electronic ballast.

Personalization options available

- Configuration layout at vibia.com
- Finish customization.
(Available options: Vibia color palette).
Min. quantity, upcharge and extra lead time apply.

Materials

Box: Aluminum.
Diffuser: Methacrylate.

Packaging

1 Box.
0,27 x 0,76 x 0,76 m.
Vol. 0,1500 m³.
Gross weight 13 Kg.
Net weight 10,4 Kg.

5380 03 Gloss white
(RAL 9010).

5380 18 Gloss graphite
(RAL 7016).



5381

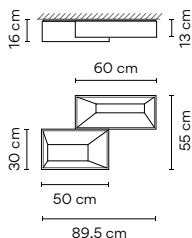

Light Source

4 x 2G11 230V 24W.
4 x 2G11 230V 18W.

Personalization options available

- Configuration layout at vibia.com
- Finish customization.
(Available options: Vibia color palette).
Min. quantity, upcharge and extra lead time apply.

Materials

Box: Aluminum.
Diffuser: Methacrylate.

Packaging

1 Box.
0,27 x 0,76 x 0,76 m.
Vol. 0,1500 m³.
Gross weight 13 Kg.
Net weight 10,4 Kg.

5381 03 Gloss white
(RAL 9010).

5381 18 Gloss graphite
(RAL 7016).



5384

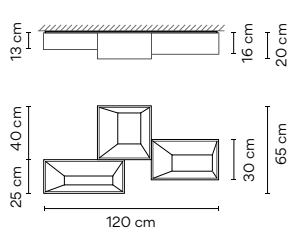

Light Source

8 x 2G11 230V 24W.
4 x 2G11 230V 18W.

Dimming: DALI, Push.

Dimmable electronic ballast.

Personalization options available

- Configuration layout at vibia.com
- Finish customization.
(Available options: Vibia color palette).
Min. quantity, upcharge and extra lead time apply.

Materials

Box: Aluminum.
Diffuser: Methacrylate.

Packaging

1 Box.
0,50 x 0,77 x 0,77 m.
Vol. 0,2960 m³.
Gross weight 20 Kg.
Net weight 16,4 Kg.

5384 03 Gloss white
(RAL 9010).

5384 18 Gloss graphite
(RAL 7016).



5385

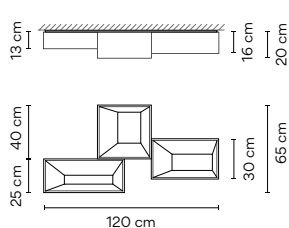

Light Source

8 x 2G11 230V 24W.
4 x 2G11 230V 18W.

Personalization options available

- Configuration layout at vibia.com
- Finish customization.
(Available options: Vibia color palette).
Min. quantity, upcharge and extra lead time apply.

Materials

Box: Aluminum.
Diffuser: Methacrylate.

Packaging

1 Box.
0,50 x 0,77 x 0,77 m.
Vol. 0,2960 m³.
Gross weight 20 Kg.
Net weight 16,4 Kg.

5385 03 Gloss white
(RAL 9010).

5385 18 Gloss graphite
(RAL 7016).



5388

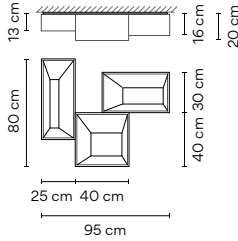

Light Source



8 x 2G11 230V 24W.
4 x 2G11 230V 18W.

Dimming: DALI, Push.

Dimmable electronic ballast.

Personalization options available

- Configuration layout at vibia.com
- Finish customization.
(Available options: Vibia color palette).
Min. quantity, upcharge and extra lead time apply.

Materials

Box: Aluminum.
Diffuser: Methacrylate.

Packaging

1 Box.
0,50 x 0,77 x 0,77 m.
Vol. 0,2960 m³.
Gross weight 20 Kg.
Net weight 16,4 Kg.

5388 03 Gloss white
(RAL 9010).

5388 18 Gloss graphite
(RAL 7016).



5389

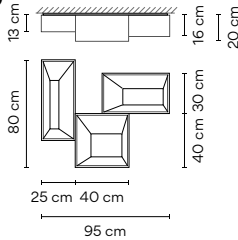

Light Source

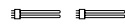

8 x 2G11 230V 24W.
4 x 2G11 230V 18W.

Personalization options available

- Configuration layout at vibia.com
- Finish customization.
(Available options: Vibia color palette).
Min. quantity, upcharge and extra lead time apply.

Materials

Box: Aluminum.
Diffuser: Methacrylate.

Packaging

1 Box.
0,50 x 0,77 x 0,77 m.
Vol. 0,2960 m³.
Gross weight 20 Kg.
Net weight 16,4 Kg.

5389 03 Gloss white
(RAL 9010).

5389 18 Gloss graphite
(RAL 7016).



5395

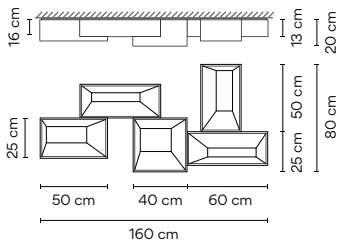

Light Source

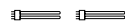

12 x 2G11 230V 24W.
8 x 2G11 230V 18W.

Dimming: DALI, Push.

Dimmable electronic ballast.

Personalization options available

- Configuration layout at vibia.com
- Finish customization.
(Available options: Vibia color palette).
Min. quantity, upcharge and extra lead time apply.

Materials

Box: Aluminum.
Diffuser: Methacrylate.

Packaging

1 Box.
0,45 x 0,95 x 0,95 m.
Vol. 0,2960 m³.
Gross weight 34 Kg.
Net weight 26,8 Kg.

5395 03 Gloss white
(RAL 9010).

5395 18 Gloss graphite
(RAL 7016).



5396

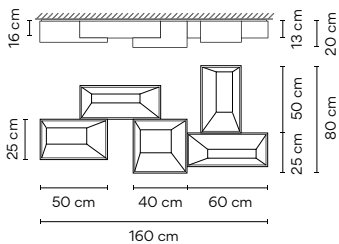

Light Source



12 x 2G11 230V 24W.
8 x 2G11 230V 18W.

Personalization options available

- Configuration layout at vibia.com
- Finish customization.
(Available options: Vibia color palette).
Min. quantity, upcharge and extra lead time apply.

Materials

Box: Aluminum.
Diffuser: Methacrylate.

Packaging

1 Box.
0,45 x 0,95 x 0,95 m.
Vol. 0,2960 m³.
Gross weight 34 Kg.
Net weight 26,8 Kg.

5396 03 Gloss white
(RAL 9010).

5396 18 Gloss graphite
(RAL 7016).



Puck

Design by Jordi Vilardell

Inspired by the classic circle silhouette, Puck panel light's simple, spherical forms can be superimposed on one another, lending sensibility overhead. Crafted of premium, opal triplex blown glass, it casts a warm glow.

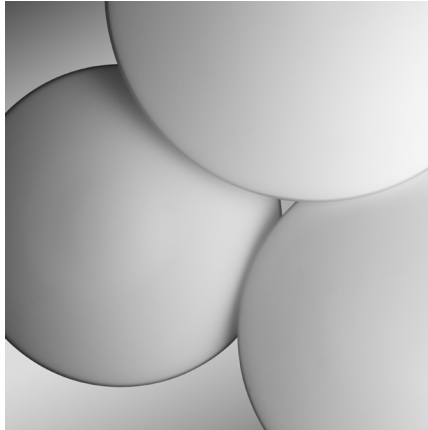

Ceiling Wall

5400

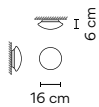

Light Source



1 x G9 230V 33W Eco Max.

Materials

Canopy: Aluminum.
Diffuser: Blown-glass.

Packaging

1 Box.
0,26 x 0,26 x 0,26 m.
Vol. 0,0175 m³.
Gross weight 0,85 Kg.
Net weight 0,6 Kg.

5400 03 White
(RAL 9016)



5402

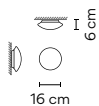

Light Source



1 x LED PLATE 3,2W 350mA.
LED 2700 K. CRI >80. 335 lm. 112 lm/W.
Driver Constant Current 350mA.
100-240V. 50/60Hz.

Personalization options available

- LED 3000 K / 4000 K.
Min. quantity, upcharge and extra lead time apply.

Materials

Canopy: Aluminum.
Diffuser: Blown-glass.

Packaging

1 Box.
0,26 x 0,26 x 0,26 m.
Vol. 0,0175 m³.
Gross weight 0,85 Kg.
Net weight 0,6 Kg.

5402 03 /10 White
(RAL 9016)



5410

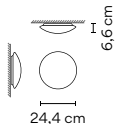

Light Source



1 x G9 230V 48W Eco Max.

Materials

Canopy: Aluminum.
Diffuser: Blown-glass.

Packaging

1 Box.
0,37 x 0,37 x 0,23 m.
Vol. 0,0315 m³.
Gross weight 0,95 Kg.
Net weight 0,7 Kg.

5410 03 White
(RAL 9016)



5412

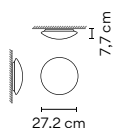

Light Source



1 x LED PLATE 7,6W 350mA.
LED 2700 K. CRI >80. 822 lm. 112 lm/W.
Driver Constant Current 350mA.
100-240V. 50/60Hz.

Personalization options available

- LED 3000 K / 4000 K.
Min. quantity, upcharge and extra lead time apply.

Materials

Canopy: Aluminum.
Diffuser: Blown-glass.











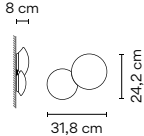





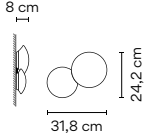







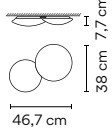





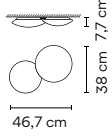







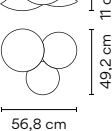

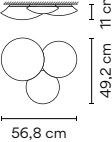

Packaging

1 Box.
0,37 x 0,37 x 0,23 m.
Vol. 0,0315 m³.
Gross weight 0,95 Kg.
Net weight 0,7 Kg.

5412 03 /10 White
(RAL 9016)



Puck

<p>5425</p> 	<p>Light Source</p> <p> 2 x G9 230V 33W Eco.</p> <p>All version require only one electrical connection.</p>	<p>Materials</p> <p>Canopy: Aluminum. Diffuser: Blown-glass.</p> <p>Packaging</p> <p>1 Box. 0,25 x 0,42 x 0,42 m. Vol. 0,0441 m³. Gross weight 2,26 Kg. Net weight 1,08 Kg.</p>	<p>5425 03 White (RAL 9016)</p> <p>    </p>
<p>5427</p> 	<p>Light Source</p> <p> 2 x LED PLATE 3,2W 350mA. LED 2700 K. CRI >80. 671 lm. 112 lm/W. Driver Constant Current 350mA. 100-240V. 50/60Hz.</p> <p>All version require only one electrical connection.</p> <p>Personalization options available - LED 3000 K / 4000 K. Min. quantity, upcharge and extra lead time apply.</p>	<p>Materials</p> <p>Canopy: Aluminum. Diffuser: Blown-glass.</p> <p>Packaging</p> <p>1 Box. 0,25 x 0,42 x 0,42 m. Vol. 0,0441 m³. Gross weight 2,26 Kg. Net weight 1,08 Kg.</p>	<p>5427 03/10 White (RAL 9016)</p> <p>     </p>
<p>5430</p> 	<p>Light Source</p> <p> 2 x G9 230V 48W Eco.</p> <p>All version require only one electrical connection.</p>	<p>Materials</p> <p>Canopy: Aluminum. Diffuser: Blown-glass.</p> <p>Packaging</p> <p>1 Box. 0,27 x 0,60 x 0,60 m. Vol. 0,0972 m³. Gross weight 4,2 Kg. Net weight 2,15 Kg.</p>	<p>5430 03 White (RAL 9016)</p> <p>    </p>
<p>5432</p> 	<p>Light Source</p> <p> 2 x LED PLATE 7,6W 350mA. LED 2700 K. CRI >80. 1640 lm. 112 lm/W. Driver Constant Current 350mA. 100-240V. 50/60Hz.</p> <p>All version require only one electrical connection.</p> <p>Personalization options available - LED 3000 K / 4000 K. Min. quantity, upcharge and extra lead time apply.</p>	<p>Materials</p> <p>Canopy: Aluminum. Diffuser: Blown-glass.</p> <p>Packaging</p> <p>1 Box. 0,27 x 0,60 x 0,60 m. Vol. 0,0972 m³. Gross weight 4,2 Kg. Net weight 2,15 Kg.</p>	<p>5432 03 /10 White (RAL 9016)</p> <p>     </p>
<p>5435</p> 	<p>Light Source</p> <p> 3 x G9 230V 48W Eco.</p> <p>All version require only one electrical connection.</p>	<p>Materials</p> <p>Canopy: Aluminum. Diffuser: Blown-glass.</p> <p>Packaging</p> <p>2 Boxes. Total Vol. 0,0780 m³. Gross weight 7,5 Kg. Net weight 4,1 Kg.</p>	<p>5435 03 White (RAL 9016)</p> <p>    </p>
<p>5437</p> 	<p>Light Source</p> <p> 3 x LED PLATE 7,6W 350mA. LED 2700 K. CRI >80. 2465 lm. 112 lm/W. Driver Constant Current 350mA. 100-240V. 50/60Hz.</p> <p>All version require only one electrical connection.</p> <p>Personalization options available - LED 3000 K / 4000 K. Min. quantity, upcharge and extra lead time apply.</p>	<p>Materials</p> <p>Canopy: Aluminum. Diffuser: Blown-glass.</p> <p>Packaging</p> <p>2 Boxes. Total Vol. 0,0883 m³. Vol. 0,1715 m³. Gross weight 6,8 Kg. Net weight 4,1 Kg.</p>	<p>5437 03 /10 White (RAL 9016)</p> <p>     </p>

Puck

5440

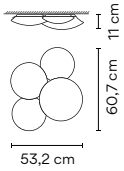

Light Source



4 x G9 230V 48W Eco.

All version require only one electrical connection.

Materials

Canopy: Aluminum.
Diffuser: Blown-glass.

Packaging

2 Boxes.
Total Vol. 0,1060 m³.
Vol. 0,1970 m³.
Gross weight 7,8 Kg.
Net weight 4,57 Kg.

5440 03 White
(RAL 9016)



5442

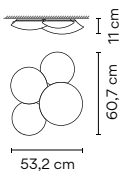

Light Source



4 x LED PLATE 7,6W 350mA.
LED 2700 K. CRI >80. 3286 lm. 112 lm/W.
Driver Constant Current 350mA.
100-240V. 50/60Hz.

All version require only one electrical connection.

Personalization options available

- LED 3000 K / 4000 K.
Min. quantity, upcharge and extra lead time apply.

Materials

Canopy: Aluminum.
Diffuser: Blown-glass.

Packaging

2 Boxes.
Total Vol. 0,1060 m³.
Vol. 0,1970 m³.
Gross weight 7,8 Kg.
Net weight 4,57 Kg.

5442 03 /10 White
(RAL 9016)



5445

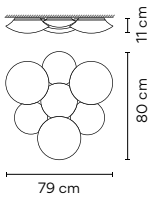

Light Source



7 x G9 230V 48W Eco.

All version require only one electrical connection.

Materials

Canopy: Aluminum.
Diffuser: Blown-glass.

Packaging

2 Boxes.
Total Vol. 0,19 m³.
Gross weight 12,5 Kg.
Net weight 8,84 Kg.

5445 03 White
(RAL 9016)



5447

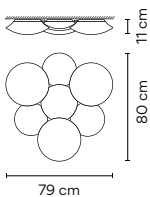

Light Source



7 x LED PLATE 7,6W 350mA.
LED 2700 K. CRI >80. 5751 lm. 112 lm/W.
Driver Constant Current 350mA.
100-240V. 50/60Hz.

All version require only one electrical connection.

Personalization options available

- LED 3000 K / 4000 K.
Min. quantity, upcharge and extra lead time apply.

Materials

Canopy: Aluminum.
Diffuser: Blown-glass.

Packaging

2 Boxes.
Total Vol. 0,19 m³.
Gross weight 12,5 Kg.
Net weight 8,84 Kg.

5447 03 /10 White
(RAL 9016)



Puck Wall Art

Design by Jordi Vilardell

Based on formats superimposed over one another on a plane of plastic dynamic compositions.



Create your product configuration quickly and easily at vibia.com

Go to vibia.com and discover the quickest, most efficient way to configure a unique lighting mural with Puck Wall Art.

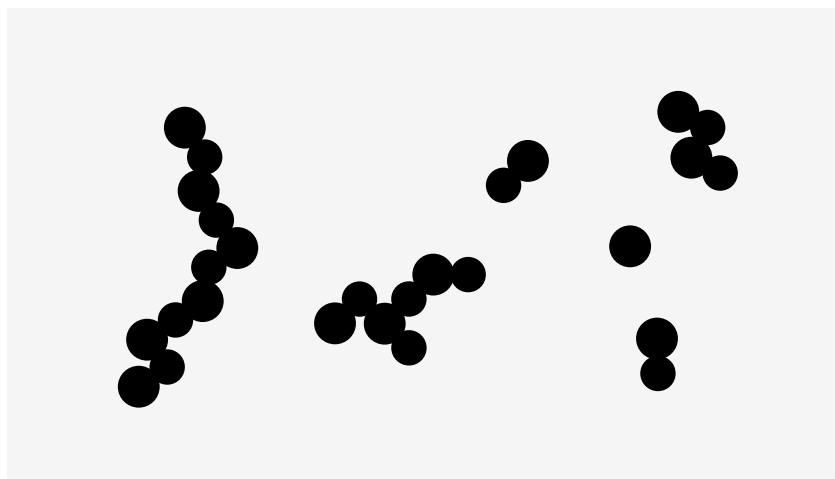

Wall

5460

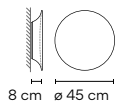

Light Source



1 x 2GX13 230V 22W (T5C).

A maximum of 40 modules can be connected to a single connection point. For bigger compositions, check connection system.

Personalization options available
- Configuration layout at vibia.com

Materials

Shade: ABS.
Diffuser: Methacrylate.

Packaging

1 Box.
0,26 x 0,51 x 0,51 m.
Vol. 0,0676 m³.
Gross weight 4,75 Kg.
Net weight 2,25 Kg.

5460 03 White
(RAL 9010)

5460 08 Orange
(PANTONE 1495M)

5460 14 Chocolate
(RAL 8019)

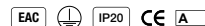

UNTIL STOCK RUNS OUT

5461

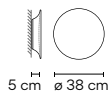

Light Source



1 x 2GX13 230V 22W (T5C).

A maximum of 40 modules can be connected to a single connection point. For bigger compositions, check connection system.

Personalization options available
- Configuration layout at vibia.com

Materials

Shade: ABS.
Diffuser: Methacrylate.

Packaging

1 Box.
0,22 x 0,46 x 0,46 m.
Vol. 0,0465 m³.
Gross weight 3,3 Kg.
Net weight 1,8 Kg.

5461 03 White
(RAL 9010)

5461 08 Orange
(PANTONE 1495M)

5461 14 Chocolate
(RAL 8019)

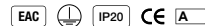

UNTIL STOCK RUNS OUT

Puck Wall Art

5464

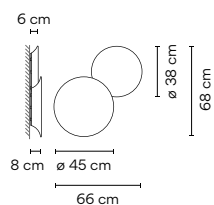

Light Source



2 x 2GX13 230V 22W (T5C).

A maximum of 40 modules can be connected to a single connection point. For bigger compositions, check connection system.

Personalization options available
- Configuration layout at vibia.com

Materials

Shade: ABS.
Diffuser: Methacrylate.

Packaging

1 Box.
0,29 x 0,51 x 0,51 m.
Vol. 0,0754 m³.
Gross weight 5,9 Kg.
Net weight 5,3 Kg.

5464 03 White
(RAL 9010)

5464 08 Orange
(PANTONE 1495M)

5464 14 Chocolate
(RAL 8019)



UNTIL STOCK RUNS OUT

5466

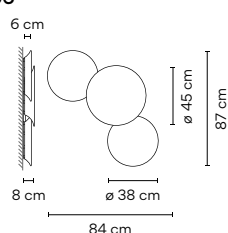

Light Source



3 x 2GX13 230V 22W (T5C).

A maximum of 40 modules can be connected to a single connection point. For bigger compositions, check connection system.

Personalization options available
- Configuration layout at vibia.com

Materials

Shade: ABS.
Diffuser: Methacrylate.

Packaging

1 Box.
0,43 x 0,51 x 0,51 m.
Vol. 0,1118 m³.
Gross weight 8,6 Kg.
Net weight 7,74 Kg.

5466 03 White
(RAL 9010)

5466 08 Orange
(PANTONE 1495M)

5466 14 Chocolate
(RAL 8019)

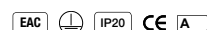

UNTIL STOCK RUNS OUT

5468

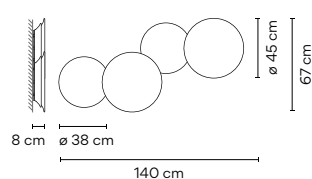

Light Source



4 x 2GX13 230V 22W (T5C).

A maximum of 40 modules can be connected to a single connection point. For bigger compositions, check connection system.

Personalization options available
- Configuration layout at vibia.com

Materials

Shade: ABS.
Diffuser: Methacrylate.

Packaging

1 Box.
0,57 x 0,51 x 0,51 m.
Vol. 0,148 m³.
Gross weight 11,2 Kg.
Net weight 10,08 Kg.

5468 03 White
(RAL 9010)

5468 08 Orange
(PANTONE 1495M)

5468 14 Chocolate
(RAL 8019)

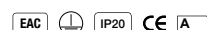

UNTIL STOCK RUNS OUT

Puck Wall Art

Design by Jordi Vilardell

Puck Wall Art is comprised of different disks to create a warm, visually sharp and mathematically creative effect. There are four sizes of disks, allowing the designer to play with varied combinations of indirect light. The resulting design comprises a set of highly dynamic, sculptural compositions.

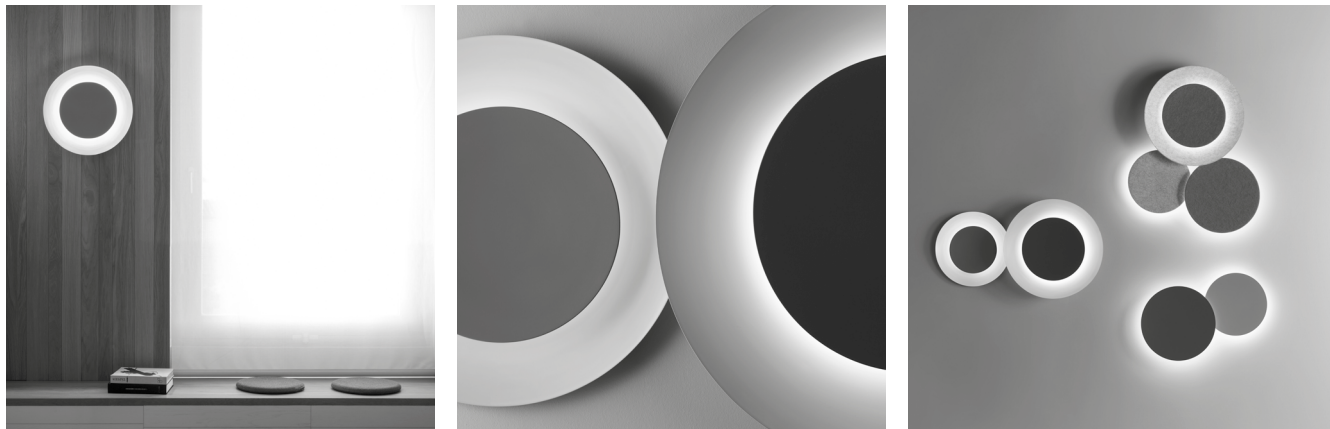

Create your product configuration quickly and easily at vibia.com

Go to vibia.com and discover the quickest, most efficient way to configure a unique lighting mural with Puck Wall Art.

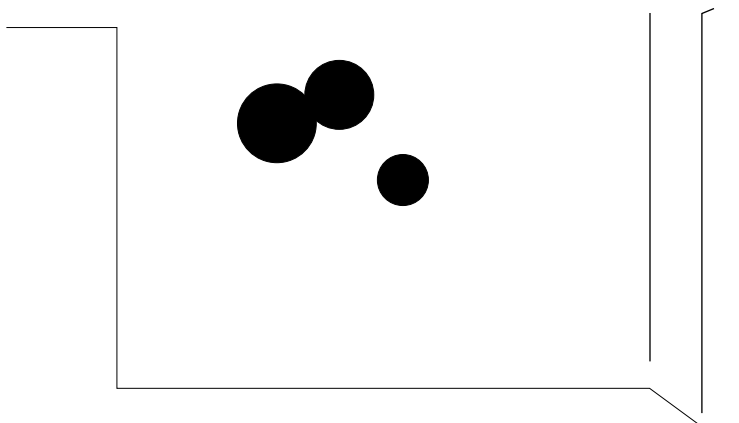

Wall

5470

New

Light Source

1 x LED STRIP 8,4W 700mA.
LED 2700 K. CRI >90. 930 lm. 110,7 lm/W.
Driver Constant Current 700mA. 50/60Hz.
/ 13: Dimming: 1-10V (110-240V). Bi-volt.
/ 14: Dimming: TRIAC (220-240V).

Personalization options available

- Configuration layout at vibia.com
- LED 4000 K.
- Dimming: DALI, Push, Casambi.
- Min. quantity, upcharge and extra lead time apply.

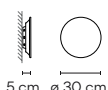

Materials

Diffuser: Polycarbonate.
Shade: ABS.
Wall support: Aluminum.

Packaging

1 Box.
0,34 x 0,34 x 0,23 m.
Vol. 0,0266 m³.
Gross weight 2,6 Kg.
Net weight 1,6 Kg.

5470 15 /13 Grey L2
(NCS S 2500-N)

5470 15 /14 Grey L2
(NCS S 2500-N)

5470 21 /13 Grey D1
(NCS S 7000-N)

5470 21 /14 Grey D1
(NCS S 7000-N)

5470 28 /13 Brown M1
(NCS S 4020-Y60R)

5470 28 /14 Brown M1
(NCS S 4020-Y60R)

5470 76 /13 Grey Felt L1

5470 76 /14 Grey Felt L1

5470 77 /13 Grey Felt D1

5470 77 /14 Grey Felt D1

EAC LED IP20 CE Bi-volt A+

AVAILABLE FROM JUNE

Puck Wall Art

5471 New **Light Source**

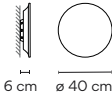

1 x LED STRIP 12,6W 700mA.
LED 2700 K. CRI >90. 1395 lm. 110,7 lm/W.
Driver Constant Current 700mA. 50/60Hz.
/ 13: Dimming: 1-10V (110-240V). Bi-volt.
/ 14: Dimming: TRIAC (220-240V).

Personalization options available
- Configuration layout at vibia.com
- LED 4000 K.
- Dimming: DALI, Push, Casambi.
Min. quantity, upcharge and extra lead time apply.

Materials
Diffuser: Polycarbonate.
Shade: ABS.
Wall support: Aluminum.

Packaging
1 Box.
0,44 x 0,44 x 0,25 m.
Vol. 0,0484 m³.
Gross weight 3,5 Kg.
Net weight 1,9 Kg.

5471 15 /13 Grey L2 (NCS S 2500-N)
5471 15 /14 Grey L2 (NCS S 2500-N)
5471 21 /13 Grey D1 (NCS S 7000-N)
5471 21 /14 Grey D1 (NCS S 7000-N)
5471 28 /13 Brown M1 (NCS S 4020-Y60R)
5471 28 /14 Brown M1 (NCS S 4020-Y60R)
5471 76 /13 Grey Felt L1
5471 76 /14 Grey Felt L1
5471 77 /13 Grey Felt D1
5471 77 /14 Grey Felt D1

EAC LED IP20 CE Bi-volt A+

AVAILABLE FROM JUNE

5472 New **Light Source**

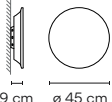

1 x LED STRIP 12,6W 700mA.
LED 2700 K. CRI >90. 1395 lm. 110,7 lm/W.
Driver Constant Current 700mA. 50/60Hz.
/ 13: Dimming: 1-10V (110-240V). Bi-volt.
/ 14: Dimming: TRIAC (220-240V).

Personalization options available
- Configuration layout at vibia.com
- LED 4000 K.
- Dimming: DALI, Push, Casambi.
Min. quantity, upcharge and extra lead time apply.

Materials
Diffuser: Polycarbonate
Shade: ABS.
Wall support: Aluminum.

Packaging
1 Box.
0,51 x 0,51 x 0,26 m.
Vol. 0,0676 m³.
Gross weight 4,75 Kg.
Net weight 2,25 Kg.

5472 15 /13 Grey L2 (NCS S 2500-N)
5472 15 /14 Grey L2 (NCS S 2500-N)
5472 21 /13 Grey D1 (NCS S 7000-N)
5472 21 /14 Grey D1 (NCS S 7000-N)
5472 28 /13 Brown M1 (NCS S 4020-Y60R)
5472 28 /14 Brown M1 (NCS S 4020-Y60R)
5472 76 /13 Grey Felt L1
5472 76 /14 Grey Felt L1
5472 77 /13 Grey Felt D1
5472 77 /14 Grey Felt D1

EAC LED IP20 CE Bi-volt A+

AVAILABLE FROM JUNE

5474 New **Light Source**

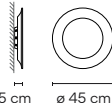

1 x LED STRIP 8,4W 700mA.
LED 2700 K. CRI >90. 930 lm. 110,7 lm/W.
Driver Constant Current 700mA. 50/60Hz.
/ 13: Dimming: 1-10V (110-240V). Bi-volt.
/ 14: Dimming: TRIAC (220-240V).

Personalization options available
- Configuration layout at vibia.com
- LED 4000 K.
- Dimming: DALI, Push, Casambi.
Min. quantity, upcharge and extra lead time apply.

Materials
Diffuser: Polycarbonate.
Shade: ABS.
Wall support: Aluminum.
Ring: Steel.

Packaging
1 Box.
0,51 x 0,51 x 0,26 m.
Vol. 0,0676 m³.
Gross weight 4,75 Kg.
Net weight 2,25 Kg.

5474 15 /13 Grey L2 (NCS S 2500-N)
5474 15 /14 Grey L2 (NCS S 2500-N)
5474 21 /13 Grey D1 (NCS S 7000-N)
5474 21 /14 Grey D1 (NCS S 7000-N)
5474 28 /13 Brown M1 (NCS S 4020-Y60R)
5474 28 /14 Brown M1 (NCS S 4020-Y60R)
5474 71 /13 Grey Felt L1 & Grey Felt D1
5474 71 /14 Grey Felt L1 & Grey Felt D1
5474 76 /13 Grey Felt L1
5474 76 /14 Grey Felt L1

EAC LED IP20 CE Bi-volt A+

AVAILABLE FROM JUNE

Puck Wall Art

5476

New

Light Source

1 x LED STRIP 12,6W 700mA.
LED 2700 K. CRI >90. 1395 lm. 110,7 lm/W.
Driver Constant Current 700mA. 50/60Hz.
/ 13: Dimming: 1-10V (110-240V). Bi-volt.
/ 14: Dimming: TRIAC (220-240V).

Personalization options available

- Configuration layout at vibia.com
- LED 4000 K.
- Dimming: DALI, Push, Casambi.
Min. quantity, upcharge and extra lead time apply.

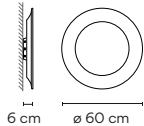

Materials

Diffuser: Polycarbonate.
Shade: ABS.
Wall support: Aluminum.
Ring: Steel.

Packaging

1 Box.
0,66 x 0,66 x 0,235 m.
Vol. 0,1024 m³.
Gross weight 6,3 Kg.
Net weight 2,9 Kg.

5476 15 /13 Grey L2
(NCS S 2500-N)

5476 15 /14 Grey L2
(NCS S 2500-N)

5476 21 /13 Grey D1
(NCS S 7000-N)

5476 21 /14 Grey D1
(NCS S 7000-N)

5476 28 /13 Brown M1
(NCS S 4020-Y60R)

5476 28 /14 Brown M1
(NCS S 4020-Y60R)

5476 71 /13 Grey Felt L1 & Grey Felt D1

5476 71 /14 Grey Felt L1 & Grey Felt D1

5476 76 /13 Grey Felt L1

5476 76 /14 Grey Felt L1



AVAILABLE FROM JUNE

5480

New

Light Source

1 x LED STRIP 8,4W 700mA.
1 x LED STRIP 12,6W 700mA.
LED 2700 K. CRI >90. 2325 lm. 110,7 lm/W.
Driver Constant Current 700mA. 50/60Hz.
/ 13: Dimming: 1-10V (110-240V). Bi-volt.
/ 14: Dimming: TRIAC (220-240V).

Personalization options available

- Configuration layout at vibia.com
- LED 4000 K.
- Dimming: DALI, Push, Casambi.
Min. quantity, upcharge and extra lead time apply.

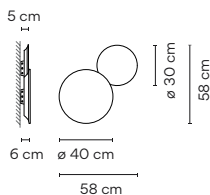

Materials

Diffuser: Polycarbonate.
Shade: ABS.
Wall support: Aluminum.

Packaging

1 Box.
0,46 x 0,46 x 0,4 m.
Vol. 0,0846 m³.
Gross weight 6,1 Kg.
Net weight 3,4 Kg.

5480 15 /13 Grey L2
(NCS S 2500-N)

5480 15 /14 Grey L2
(NCS S 2500-N)

5480 28 /13 Brown M1
(NCS S 4020-Y60R)

5480 28 /14 Brown M1
(NCS S 4020-Y60R)

5480 71 /13 Grey Felt L1 & Grey Felt D1

5480 71 /14 Grey Felt L1 & Grey Felt D1

5480 72 /13 Grey D1 & Grey L2

5480 72 /14 Grey D1 & Grey L2

5480 76 /13 Grey Felt L1

5480 76 /14 Grey Felt L1

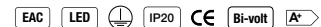

AVAILABLE FROM JUNE

5481

New

Light Source

2 x LED STRIP 12,6W 700mA.
LED 2700 K. CRI >90. 2790 lm. 110,7 lm/W.
Driver Constant Current 700mA. 50/60Hz.
/ 13: Dimming: 1-10V (110-240V). Bi-volt.
/ 14: Dimming: TRIAC. Push. (220-240V).

Personalization options available

- Configuration layout at vibia.com
- LED 4000 K.
- Dimming: DALI, Push, Casambi.
Min. quantity, upcharge and extra lead time apply.

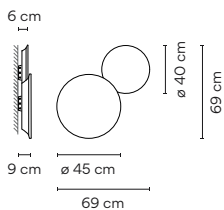

Materials

Diffuser: Polycarbonate.
Shade: ABS.
Wall support: Aluminum.

Packaging

1 Box.
0,51 x 0,51 x 0,43 m.
Vol. 0,1118 m³.
Gross weight 8,25 Kg.
Net weight 4,15 Kg.

5481 15 /13 Grey L2
(NCS S 2500-N)

5481 15 /14 Grey L2
(NCS S 2500-N)

5481 28 /13 Brown M1
(NCS S 4020-Y60R)

5481 28 /14 Brown M1
(NCS S 4020-Y60R)

5481 71 /13 Grey Felt L1 & Grey Felt D1

5481 71 /14 Grey Felt L1 & Grey Felt D1

5481 72 /13 Grey D1 & Grey L2

5481 72 /14 Grey D1 & Grey L2

5481 76 /13 Grey Felt L1

5481 76 /14 Grey Felt L1

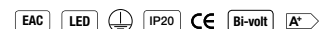

AVAILABLE FROM JUNE

Puck Wall Art

5485

New

Light Source

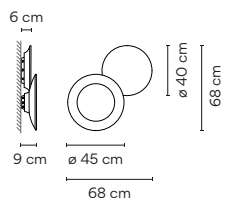

1 x LED STRIP 8,4W 700mA.
1 x LED STRIP 12,6W 700mA.
LED 2700 K. CRI >90. 2325 lm. 110,7 lm/W.
Driver Constant Current 700mA. 50/60Hz.
/ 13: Dimming: 1-10V (110-240V). Bi-volt.
/ 14: Dimming: TRIAC (220-240V).

Personalization options available

- Configuration layout at vibia.com
 - LED 4000 K.
 - Dimming: DALI, Push, Casambi.
- Min. quantity, upcharge and extra lead time apply.

Materials

Diffuser: Polycarbonate.
Shade: ABS.
Wall support: Aluminum.
Ring: Steel

Packaging

1 Box.
0,51 x 0,51 x 0,43 m.
Vol. 0,1118 m³.
Gross weight 8,42 Kg.
Net weight 4,22 Kg.

5485 71 /13 Grey Felt L1 & Grey Felt D1

5485 71 /14 Grey Felt L1 & Grey Felt D1

5485 72 /13 Grey D1 & Grey L2

5485 72 /14 Grey D1 & Grey L2

5485 73 /13 Brown M1 & Grey D1

5485 73 /14 Brown M1 & Grey D1

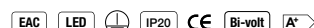

AVAILABLE FROM JUNE

5486

New

Light Source

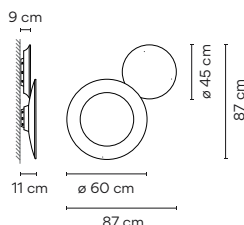

2 x LED STRIP 12,6W 700mA.
LED 2700 K. CRI >90. 2790 lm. 110,7 lm/W.
Driver Constant Current 700mA. 50/60Hz.
/ 13: Dimming: 1-10V (110-240V). Bi-volt.
/ 14: Dimming: TRIAC (220-240V).

Personalization options available

- Configuration layout at vibia.com
 - LED 4000 K.
 - Dimming: DALI, Push, Casambi.
- Min. quantity, upcharge and extra lead time apply.

Materials

Diffuser: Polycarbonate.
Shade: ABS.
Wall support: Aluminum.
Ring: Steel.

Packaging

1 Box.
0,66 x 0,66 x 0,5 m.
Vol. 0,2178 m³.
Gross weight 11,35 Kg.
Net weight 5,45 Kg.

5486 71 /13 Grey Felt L1 & Grey Felt D1

5486 71 /14 Grey Felt L1 & Grey Felt D1

5486 72 /13 Grey D1 & Grey L2

5486 72 /14 Grey D1 & Grey L2

5486 73 /13 Brown M1 & Grey D1

5486 73 /14 Brown M1 & Grey D1

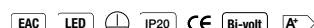

AVAILABLE FROM JUNE

5487

New

Light Source

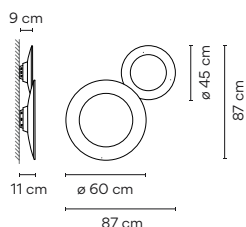

1 x LED STRIP 8,4W 700mA.
1 x LED STRIP 12,6W 700mA.
LED 2700 K. CRI >90. 2325 lm. 110,7 lm/W.
Driver Constant Current 700mA. 50/60Hz.
/ 13: Dimming: 1-10V (110-240V). Bi-volt.
/ 14: Dimming: TRIAC (220-240V).

Personalization options available

- Configuration layout at vibia.com
 - LED 4000 K.
 - Dimming: DALI, Push, Casambi.
- Min. quantity, upcharge and extra lead time apply.

Materials

Diffuser: Polycarbonate.
Shade: ABS.
Wall support: Aluminum.
Ring: Steel.

Packaging

1 Box.
0,66 x 0,66 x 0,5 m.
Vol. 0,2178 m³.
Gross weight 11,52 Kg.
Net weight 5,62 Kg.

5487 21 /13 Grey D1
(NCS S 7000-N)

5487 21 /14 Grey D1
(NCS S 7000-N)

5487 71 /13 Grey Felt L1 & Grey Felt D1

5487 71 /14 Grey Felt L1 & Grey Felt D1

5487 73 /13 Brown M1 & Grey D1

5487 73 /14 Brown M1 & Grey D1

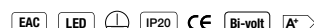

AVAILABLE FROM JUNE

5491

New

Light Source

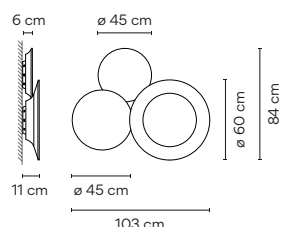

3 x LED STRIP 12,6W 700mA.
LED 2700 K. CRI >90. 4185 lm. 110,7 lm/W.
Driver Constant Current 700mA. 50/60Hz.
/ 13: Dimming: 1-10V (110-240V). Bi-volt.
/ 14: Dimming: TRIAC (220-240V).

Personalization options available

- Configuration layout at vibia.com
 - LED 4000 K.
 - Dimming: DALI, Push, Casambi.
- Min. quantity, upcharge and extra lead time apply.

Materials

Diffuser: Polycarbonate.
Shade: ABS.
Wall support: Aluminum.
Ring: Steel.

Packaging

1 Box.
0,66 x 0,66 x 0,67 m.
Vol. 0,2919 m³.
Gross weight 14,85 Kg.
Net weight 7,35 Kg.

5491 71 /13 Grey Felt L1 & Grey Felt D1

5491 71 /14 Grey Felt L1 & Grey Felt D1

5491 72 /13 Grey D1 & Grey L2

5491 72 /14 Grey D1 & Grey L2

5491 73 /13 Brown M1 & Grey D1

5491 73 /14 Brown M1 & Grey D1

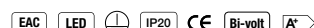

AVAILABLE FROM JUNE

Mayfair

Design by Diego Fortunato

Mayfair is a modern reimagining of the traditional 19th-century lights, distinguished by its timeless design and sleek silhouette.



Table

5500

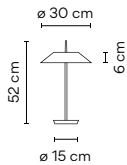

Light Source

1 x LED STRIP 24V 2,4W.
1 x LED STRIP 24V 12,6W.
LED 2700 K. CRI >80. 1841 lm. 96 lm/W.
Driver Constant Voltage 24V.
100-240V. 50/60Hz.
Dimming: Optical Sensor.

Touch dimmer on base. Electric cable 2 m.

Materials

Diffuser: Polycarbonate.
Shade: Methacrylate.
Tube: Steel.
Base: Zamak.

Packaging

1 Box.
0,22 x 0,35 x 0,61 m.
Vol. 0,0470 m³.
Gross weight 3,6 Kg.
Net weight 3,4 Kg.

5500 07 /16 Graphite and green
(RAL 7016. RAL 6026)

5500 08 /16 Graphite and orange
(RAL 7016. RAL 2009)

EAC LED IP20 CE Dimmer Bi-volt A+

5505

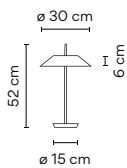

Light Source

1 x LED STRIP 24V 2,4W.
1 x LED STRIP 24V 12,6W.
LED 2700 K. CRI >80. 1841 lm. 96 lm/W.
Driver Constant Voltage 24V.
100-240V. 50/60Hz.
Dimming: Optical Sensor.

Touch dimmer on base. Electric cable 2 m.

Materials

Diffuser: Polycarbonate.
Shade and tube: Steel.
Base: Zamak.

Packaging

1 Box.
0,22 x 0,35 x 0,61 m.
Vol. 0,0470 m³.
Gross weight 3,7 Kg.
Net weight 3,5 Kg.

5505 18 /16 Graphite
(RAL 7016)

5505 20 /16 Gold
(Gold)

5505 67 /16 Copper
(Copper)

5505 93 /16 White
(RAL 9016)

EAC LED IP20 CE Dimmer Bi-volt A+

Personalization options available

- Finish customization.
(Available options: Vibia color palette).
Min. quantity, upcharge and extra lead time apply.

Floor

5510

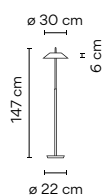

Light Source

1 x LED STRIP 24V 2,4W.
1 x LED STRIP 24V 12,6W.
LED 2700 K. CRI >80. 1841 lm. 96 lm/W.
Driver Constant Voltage 24V.
100-240V. 50/60Hz.
Dimming: Optical Sensor.

Touch dimmer on shade. Electric cable 2 m.

Materials

Diffuser: Polycarbonate.
Shade: Methacrylate.
Tube: Steel.
Base: Zamak.

Packaging

1 Box.
1,50 x 0,32 x 0,34 m.
Vol. 0,1630 m³.
Gross weight 12,8 Kg.
Net weight 6,2 Kg.

5510 07 /16 Graphite and green
(RAL 7016. RAL 6026)

5510 08 /16 Graphite and orange
(RAL 7016. RAL 2009)

EAC LED IP20 CE Dimmer Bi-volt A+

5515

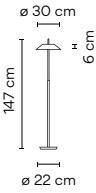

Light Source

1 x LED STRIP 24V 2,4W.
1 x LED STRIP 24V 12,6W.
LED 2700 K. CRI >80. 1841 lm. 96 lm/W.
Driver Constant Voltage 24V.
100-240V. 50/60Hz.
Dimming: Optical Sensor.

Touch dimmer on shade. Electric cable 2 m.

Personalization options available

- Finish customization.
(Available options: Vibia color palette).

Min. quantity, upcharge and extra lead time apply.

Materials

Diffuser: Polycarbonate.
Shade and Tube: Steel.
Base: Zamak.

Packaging

1 Box.
1,50 x 0,32 x 0,34 m.
Vol. 0,1630 m³.
Gross weight 12,9 Kg.
Net weight 6,3 Kg.

5515 18 /16 Graphite (RAL 7016)
5515 20 /16 Gold (Gold)
5515 67 /16 Copper (Copper)
5515 93 /16 White (RAL 9016)

EAC LED IP20 CE Dimmer Bi-volt A+

Pendants

5520

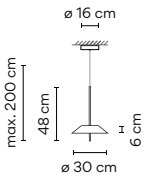

Light Source

1 x LED STRIP 24V 2,4W.
1 x LED STRIP 24V 12,6W.
LED 2700 K. CRI >80. 1841 lm. 96 lm/W.
Driver Constant Voltage 24V.
220-240V. 50/60Hz.
Dimming: 1-10V, Push.

Personalization options available

- Dimming: DALI or Casambi.
- Extra cable length.

Min. quantity, upcharge and extra lead time apply.

Materials

Diffuser: Polycarbonate.
Shade: Methacrylate.
Tube and canopy: Steel.

Packaging

1 Box.
0,50 x 0,31 x 0,31 m.
Vol. 0,0500 m³.
Gross weight 2,8 Kg.
Net weight 1,8 Kg.

5520 07 /1B Graphite and green (RAL 7016. RAL 6026)
5520 08 /1B Graphite and orange (RAL 7016 . RAL 2009)

EAC LED IP20 CE A+

5525

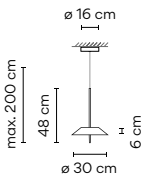

Light Source

1 x LED STRIP 24V 2,4W.
1 x LED STRIP 24V 12,6W.
LED 2700 K. CRI >80. 1841 lm. 96 lm/W.
Driver Constant Voltage 24V.
220-240V. 50/60Hz.
Dimming: 1-10V, Push.

Personalization options available

- Finish customization.
(Available options: Vibia color palette).
- Dimming: DALI or Casambi.
- Extra cable length.

Min. quantity, upcharge and extra lead time apply.

Materials

Diffuser: Polycarbonate.
Shade, tube and canopy: Steel.

Packaging

1 Box.
0,50 x 0,31 x 0,31 m.
Vol. 0,0500 m³.
Gross weight 2,9 Kg.
Net weight 1,9 Kg.

5525 18 /1B Graphite (RAL 7016)
5525 20 /1B Gold (Gold)
5525 67 /1B Copper (Copper)
5525 93 /1B White (RAL 9016)

EAC LED IP20 CE A+

5530

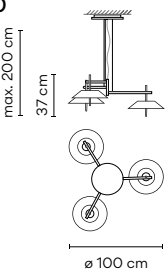

Light Source

3 x LED STRIP 24V 2,4W.
3 x LED STRIP 24V 12,6W.
LED 2700 K. CRI >80. 5521,5 lm. 96 lm/W.
Driver Constant Voltage 24V.
100-277V. 50/60Hz.
Dimming: 1-10V.

Personalization options available

- Dimming: DALI or Casambi.
- Extra cable length.

Min. quantity, upcharge and extra lead time apply.

Materials

Diffuser: Polycarbonate.
Shade: Methacrylate.
Tube and canopy: Steel.

Packaging

1 Box.
0,27 x 0,76 x 0,76 m.
Vol. 0,1610 m³.
Gross weight 9,8 Kg.
Net weight 6,5 Kg.

5530 07 /13 Graphite and green (RAL 7016. RAL 6026)
5530 08 /13 Graphite and orange (RAL 7016 RAL 2009)

EAC LED IP20 CE Multi-volt A+

5535

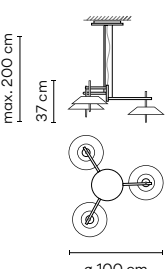

Light Source

3 x LED STRIP 24V 2,4W.
3 x LED STRIP 24V 12,6W.
LED 2700 K. CRI >80. 5521,5 lm. 96 lm/W.
Driver Constant Voltage 24V.
100-277V. 50/60Hz.
Dimming: 1-10V.

Personalization options available

- Finish customization.
(Available options: Vibia color palette).
- Dimming: DALI or Casambi.
- Extra cable length.

Min. quantity, upcharge and extra lead time apply.

Materials

Diffuser: Polycarbonate.
Shade, tube and canopy: Steel.

Packaging

1 Box.
0,37 x 0,76 x 0,76 m.
Vol. 0,1610 m³.
Gross weight 10 Kg.
Net weight 6,8 Kg.

5535 18 /13 Graphite (RAL 7016)
5535 20 /13 Gold (Gold)
5535 67 /13 Copper (Copper)
5535 93 /13 White (RAL 9016)

EAC LED IP20 CE Multi-volt A+

North

Design by Arik Levy

North, south, east and west are our points of references in space; we set-out, build and travel according to these coordinates.



Height-adjustable shade.

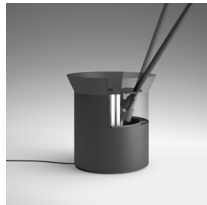

Adjustable-angle rods. Can be connected with or without plug.



Can be connected with or without plug.

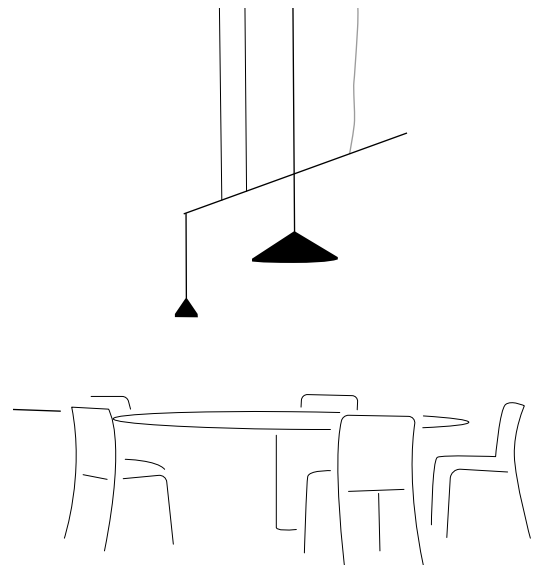
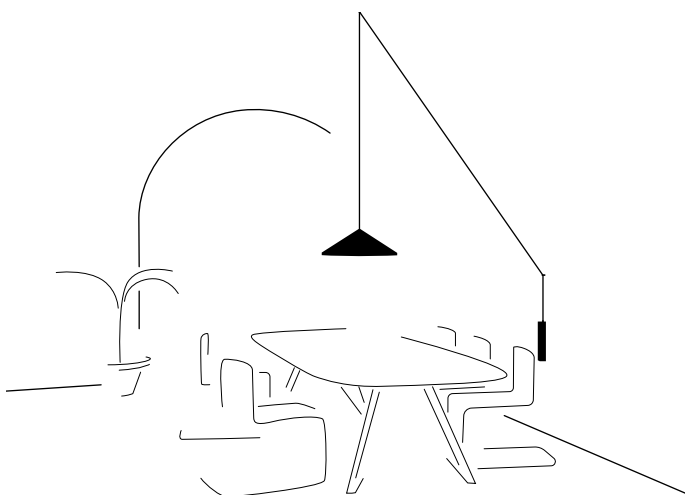

Floor

5600

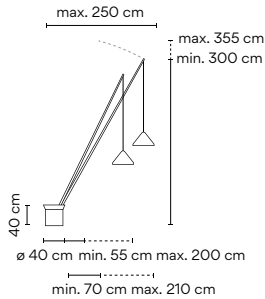

Light Source

2 x LED 9W 350mA.
LED 2700 K. CRI >80.
2082,1 lm. 116 lm/W.
Driver Constant Current 350mA.
220-240V. 50/60Hz.
Dimming: Push.
Can be connected with or without plug.
Electric cable 2,5 m.

Personalization options available

- LED 3000 K / 4000 K.
Min. quantity, upcharge and extra lead time apply.

Materials

Rods: Carbon fiber.
Shade: Aluminum.
Diffuser: Methacrylate.
Base: Steel.

Packaging

10 Boxes.
Total Vol. 0,37 m³.
Gross weight 92,05 Kg.
Net weight 79,95 Kg.

5600 10 /15 White
(NCS S 0300-N)

5600 11 /15 Black
(NCS S 8500 N)

5600 24 /15 Beige M1
(NCS S 2005-Y50R)

5600 42 /15 Blue M1
(NCS S 5010-B10G)

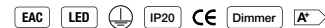

5605

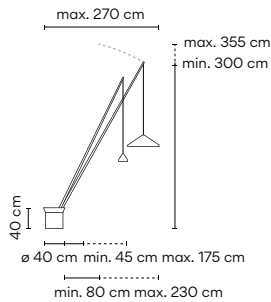

Light Source

2 x LED 9W 350mA.
LED 2700 K. CRI >80.
2082,1 lm. 116 lm/W.
Driver Constant Current 350mA.
220-240V. 50/60Hz.
Dimming: Push.
Can be connected with or without plug.
Electric cable 2,5 m.

Personalization options available

- LED 3000 K / 4000 K.
Min. quantity, upcharge and extra lead time apply.

Materials

Rods: Carbon fiber.
Shade: Aluminum.
Diffuser: Methacrylate.
Base: Steel.

Packaging

10 Boxes.
Total Vol. 0,35 m³.
Gross weight 91 Kg.
Net weight 79,8 Kg.

5605 10 /15 White
(NCS S 0300-N)

5605 11 /15 Black
(NCS S 8500 N)

5605 24 /15 Beige M1
(NCS S 2005-Y50R)

5605 42 /15 Blue M1
(NCS S 5010-B10G)

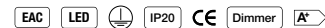

5620

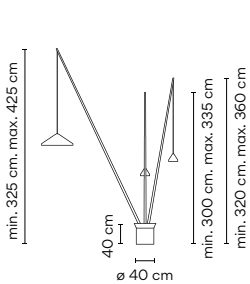

Light Source

3 x LED 9W 350mA.
LED 2700 K. CRI >80.
3123,1 lm. 116 lm/W.
Driver Constant Current 350mA.
220-240V. 50/60Hz.
Dimming: Push.
Can be connected with or without plug.
Electric cable 2,5 m.

Personalization options available

- LED 3000 K / 4000 K.
Min. quantity, upcharge and extra lead time apply.

Materials

Rods: Carbon fiber.
Shade: Aluminum.
Diffuser: Methacrylate.
Base: Steel.

Packaging

12 Boxes.
Total Vol. 0,36 m³.
Gross weight 94,85 Kg.
Net weight 81,25 Kg.

5620 10 /15 White
(NCS S 0300-N)

5620 11 /15 Black
(NCS S 8500 N)

5620 24 /15 Beige M1
(NCS S 2005-Y50R)

5620 42 /15 Blue M1
(NCS S 5010-B10G)

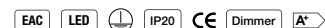

5625

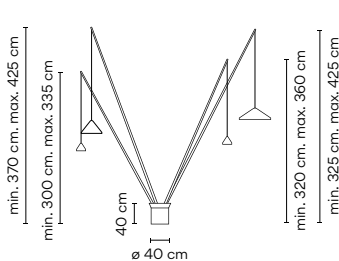

Light Source

4 x LED 9W 350mA.
LED 2700 K. CRI >80.
4164,1 lm. 116 lm/W.
Driver Constant Current 350mA.
220-240V. 50/60Hz.
Dimming: Push.
Can be connected with or without plug.
Electric cable 2,5 m.

Personalization options available

- LED 3000 K / 4000 K.
Min. quantity, upcharge and extra lead time apply.

Materials

Rods: Carbon fiber.
Shade: Aluminum.
Diffuser: Methacrylate.
Base: Steel.

Packaging

14 Boxes.
Total Vol. 0,47 m³.
Gross weight 101,20 Kg.
Net weight 83,55 Kg.

5625 10 /15 White
(NCS S 0300-N)

5625 11 /15 Black
(NCS S 8500 N)

5625 24 /15 Beige M1
(NCS S 2005-Y50R)

5625 42 /15 Blue M1
(NCS S 5010-B10G)

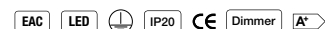

5666

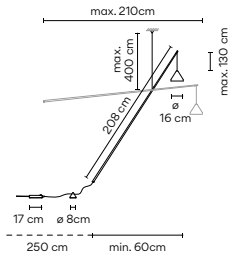

Light Source

1 x LED 9W 350mA.
LED 2700 K, CRI >80.
1041 lm, 115,66 lm/W.
Driver Constant Current 350mA.
110-240V, 50/60Hz.
Dimming: Push.

Electric cable with plug.
Electric cable 3 m.

Personalization options available
- LED 3000 K / 4000 K.
- Extra cable length.
Min. quantity, upcharge and extra lead time apply.

Materials

Rods: Carbon fiber.
Shade: Aluminum.
Diffuser: Methacrylate.
Counterweight:
Aluminum.

Packaging

2 Boxes.
0,24 x 0,217 x 0,21 m.
Total Vol. 0,0464 m³.
Gross weight 6,2 Kg.
Net weight 4,05 Kg.

5666 10 /15 White
(NCS S 0300-N)

5666 11 /15 Black
(NCS S 8500 N)

5666 24 /15 Beige M1
(NCS S 2005-Y50R)

5666 42 /15 Blue M1
(NCS S 5010-B10G)



Wall

5630

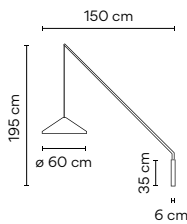

Light Source

1 x LED 9W 350mA.
LED 2700 K, CRI >80, 1041 lm, 116 lm/W.
Driver Constant Current 350mA.
110-240V, 50/60Hz.
Dimming: Push

Push-button on the wall plate.
Can be connected with or without plug.
Electric cable 1,5 m.

Personalization options available
- LED 3000 K / 4000 K.
Min. quantity, upcharge and extra lead time apply.

Materials

Rod: Carbon fiber.
Diffuser: Methacrylate.
Shade: Aluminum.
Wall Plate: Steel.

Packaging

3 Boxes.
Total Vol. 0,24 m³.
Gross weight 11,05 Kg.
Net weight 5,85 Kg.

5630 10 /15 White
(NCS S 0300-N)

5630 11 /15 Black
(NCS S 8500 N)

5630 24 /15 Beige M1
(NCS S 2005-Y50R)

5630 42 /15 Blue M1
(NCS S 5010-B10G)



5635

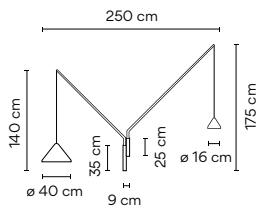

Light Source

2 x LED 9W 350mA.
LED 2700 K, CRI >80.
2082,1 lm, 116 lm/W.
Driver Constant Current 350mA.
220-240V, 50/60Hz.
Dimming: Push.

Push-button on the wall plate.
Can be connected with or without plug.
Electric cable 1,5 m.

Personalization options available
- LED 3000 K / 4000 K.
Min. quantity, upcharge and extra lead time apply.

Materials

Rods: Carbon fiber.
Diffuser: Methacrylate.
Shade: Aluminum.
Wall Plate: Steel.

Packaging

4 Boxes.
Total Vol. 0,18 m³.
Gross weight 14,6 Kg.
Net weight 7,3 Kg.

5635 10 /15 White
(NCS S 0300-N)

5635 11 /15 Black
(NCS S 8500 N)

5635 24 /15 Beige M1
(NCS S 2005-Y50R)

5635 42 /15 Blue M1
(NCS S 5010-B10G)

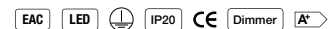

5640

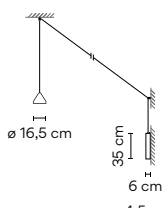

Light Source

1 x LED 9W 350mA.
LED 2700 K, CRI >80, 1041 lm, 116 lm/W.
Driver Constant Current 350mA.
110-240V, 50/60Hz.
Dimming: Push.

Push-button on the wall plate.
Length of light electric cable 10 m.
Can be connected with or without plug.
Electric cable 1,5 m.

Personalization options available
- LED 3000 K / 4000 K.
Min. quantity, upcharge and extra lead time apply.

Materials

Diffuser: Methacrylate.
Shade: Aluminum.
Wall Plate: Steel.

Packaging

2 Boxes.
Total Vol. 0,04 m³.
Gross weight 5,2 Kg.
Net weight 2,75 Kg.

5640 10 /15 White
(NCS S 0300-N)

5640 11 /15 Black
(NCS S 8500 N)

5640 24 /15 Beige M1
(NCS S 2005-Y50R)

5640 42 /15 Blue M1
(NCS S 5010-B10G)



5642

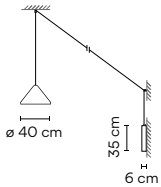

Light Source



1 x LED 9W 350mA.
LED 2700 K, CRI >80, 1041 lm, 116 lm/W.
Driver Constant Current 350mA.
 110-240V, 50/60Hz.
Dimming: Push.

Push-button on the wall plate.
 Length of light electric cable 10 m.
 Can be connected with or without plug.
 Electric cable 1,5 m.

Personalization options available

- LED 3000 K / 4000 K.
 Min. quantity, upcharge and extra lead time apply.

Materials

Diffuser: Methacrylate.
 Shade: Aluminum.
 Wall Plate: Steel.

Packaging

2 Boxes.
 Total Vol. 0,12 m³.
 Gross weight 7,7 Kg.
 Net weight 3,75 Kg.

5642 10 /15 White
 (NCS S 0300-N)

5642 11 /15 Black
 (NCS S 8500 N)

5642 24 /15 Beige M1
 (NCS S 2005-Y50R)

5642 42 /15 Blue M1
 (NCS S 5010-B10G)



5644

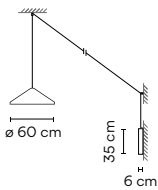

Light Source



1 x LED 9W 350mA.
LED 2700 K, CRI >80, 1041 lm, 116 lm/W.
Driver Coanstant Current 350mA.
 110-240V, 50/60Hz.
Dimming: Push.

Push-button on the wall plate.
 Length of light electric cable 10 m.
 Can be connected with or without plug.
 Electric cable 1,5 m.

Personalization options available

- LED 3000 K / 4000 K.
 Min. quantity, upcharge and extra lead time apply.

Materials

Diffuser: Methacrylate.
 Shade: Aluminum.
 Wall Plate: Steel.

Packaging

2 Boxes.
 Total Vol. 0,20 m³.
 Gross weight 9,15 Kg.
 Net weight 4,45 Kg.

5644 10 /15 White
 (NCS S 0300-N)

5644 11 /15 Black
 (NCS S 8500 N)

5644 24 /15 Beige M1
 (NCS S 2005-Y50R)

5644 42 /15 Blue M1
 (NCS S 5010-B10G)



Pendants

5660

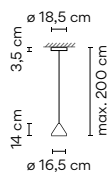

Light Source



1 x LED 9W 350mA.
LED 2700 K, CRI >80, 1041 lm, 116 lm/W.
Driver Constant Current 350mA.
 110-240V, 50/60Hz.
Dimming: 1-10V, Push.

Personalization options available

- LED 3000 K / 4000 K.
 - Dimming: DALI or Casambi.
 - Extra cable length.
 Min. quantity, upcharge and extra lead time apply.

Materials

Shade: Aluminum.
 Diffuser: Methacrylate.
 Canopy: Steel.

Packaging

1 Box.
 0,24 x 0,217 x 0,217 m.
 Vol. 0,01 m³.
 Gross weight 2,3 Kg.
 Net weight 1,25 Kg.

5660 10 /1B White
 (NCS S 0300-N)

5660 11 /1B Black
 (NCS S 8500 N)

5660 24 /1B Beige M1
 (NCS S 2005-Y50R)

5660 42 /1B Blue M1
 (NCS S 5010-B10G)



5662

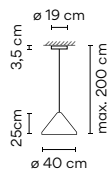

Light Source



1 x LED 9W 350mA.
LED 2700 K, CRI >80, 1041 lm, 116 lm/W.
Driver Constant Current 350mA.
 110-240V, 50/60Hz.
Dimming: 1-10V, Push.

Personalization options available

- LED 3000 K / 4000 K.
 - Dimming: DALI or Casambi.
 - Extra cable length.
 Min. quantity, upcharge and extra lead time apply.

Materials

Shade: Aluminum.
 Diffuser: Methacrylate.
 Canopy: Steel.

Packaging

1 Box.
 0,36 x 0,537 x 0,537 m.
 Vol. 0,10 m³.
 Gross weight 4,8 Kg.
 Net weight 2,25 Kg.

5662 10 /1B White
 (NCS S 0300-N)

5662 11 /1B Black
 (NCS S 8500 N)

5662 24 /1B Beige M1
 (NCS S 2005-Y50R)

5662 42 /1B Blue M1
 (NCS S 5010-B10G)

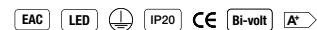

5664

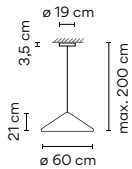

Light Source

1 x LED 9W 350mA.
LED 2700 K. CRI >80. 1041 lm. 116 lm/W.
Driver Constant Current 350mA.
110-240V. 50/60Hz.
Dimming: 1-10V, Push.

Personalization options available
- LED 3000 K / 4000 K.
- Dimming: DALI or Casambi.
- Extra cable length.
Min. quantity, upcharge and extra lead time apply.

Materials

Shade: Aluminum.
Diffuser: Methacrylate.
Canopy: Steel.

Packaging

1 Box.
0,32 x 0,727 x 0,727 m.
Vol. 0,17 m³.
Gross weight 6,25 Kg.
Net weight 2,95 Kg.

5664 10 /1B White
(NCS S 0300-N)

5664 11 /1B Black
(NCS S 8500 N)

5664 24 /1B Beige M1
(NCS S 2005-Y50R)

5664 42 /1B Blue M1
(NCS S 5010-B10G)



5670

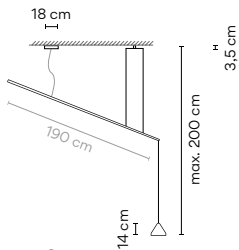

Light Source

1 x LED 9W 350mA.
LED 2700 K. CRI >80. 1041 lm. 116 lm/W.
Driver Constant Current 350mA.
110-240V. 50/60Hz.
Dimming: 1-10V, Push.

Personalization options available
- LED 3000 K / 4000 K.
- Dimming: DALI or Casambi.
- Extra cable length.
Min. quantity, upcharge and extra lead time apply.

Materials

Rods: Carbon fiber.
Shade: Aluminum.
Diffuser: Methacrylate.
Canopy: Steel.

Packaging

2 Boxes.
Total Vol. 0,06 m³.
Gross weight 5,75 Kg.
Net weight 2 Kg.

5670 10 /1B White
(NCS S 0300-N)

5670 11 /1B Black
(NCS S 8500 N)

5670 24 /1B Beige M1
(NCS S 2005-Y50R)

5670 42 /1B Blue M1
(NCS S 5010-B10G)

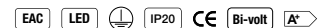

5672

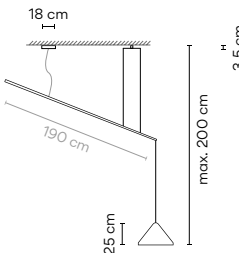

Light Source

1 x LED 9W 350mA.
LED 2700 K. CRI >80. 1041 lm. 116 lm/W.
Driver Constant Current 350mA.
110-240V. 50/60Hz.
Dimming: 1-10V, Push.

Personalization options available
- LED 3000 K / 4000 K.
- Dimming: DALI or Casambi.
- Extra cable length.
Min. quantity, upcharge and extra lead time apply.

Materials

Rods: Carbon fiber.
Shade: Aluminum.
Diffuser: Methacrylate.
Canopy: Steel.

Packaging

2 Boxes.
Total Vol. 0,14 m³.
Gross weight 8,25 Kg.
Net weight 3 Kg.

5672 10 /1B White
(NCS S 0300-N)

5672 11 /1B Black
(NCS S 8500 N)

5672 24 /1B Beige M1
(NCS S 2005-Y50R)

5672 42 /1B Blue M1
(NCS S 5010-B10G)

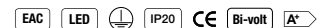

5674

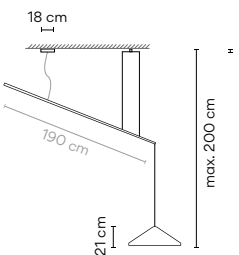

Light Source

1 x LED 9W 350mA.
LED 2700 K. CRI >80. 1041 lm. 116 lm/W.
Driver Constant Current 350mA.
110-240V. 50/60Hz.
Dimming: 1-10V, Push.

Personalization options available
- LED 3000 K / 4000 K.
- Dimming: DALI or Casambi.
- Extra cable length.
Min. quantity, upcharge and extra lead time apply.

Materials

Rods: Carbon fiber.
Shade: Aluminum.
Diffuser: Methacrylate.
Canopy: Steel.

Packaging

2 Boxes.
Total Vol. 0,21 m³.
Gross weight 9,7 Kg.
Net weight 3,7 Kg.

5674 10 /1B White
(NCS S 0300-N)

5674 11 /1B Black
(NCS S 8500 N)

5674 24 /1B Beige M1
(NCS S 2005-Y50R)

5674 42 /1B Blue M1
(NCS S 5010-B10G)



Centric

Design by Ramos & Bassols

Some design objects can integrate with the architecture, influencing it by making rooms come alive.

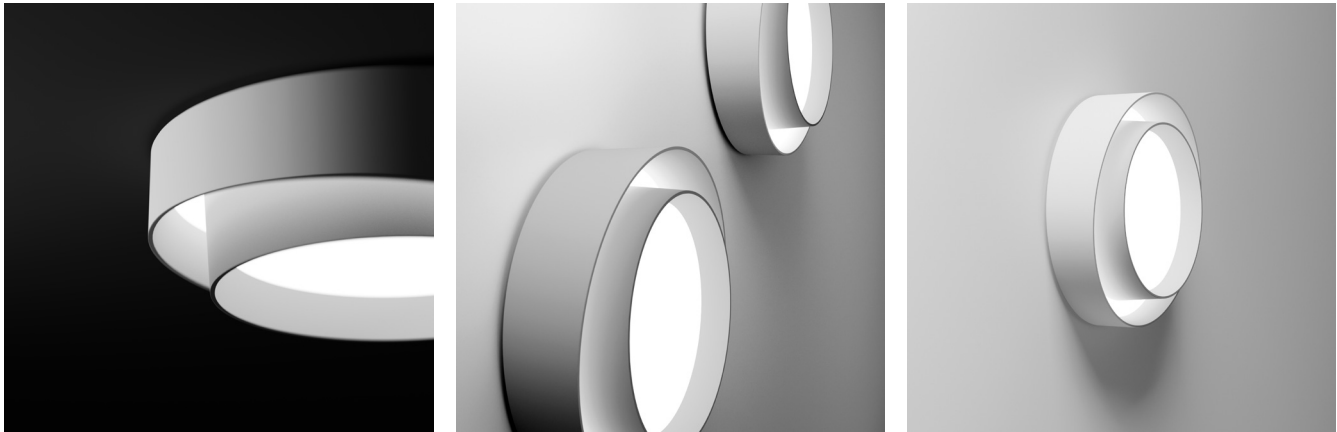

Ceiling Wall

5700

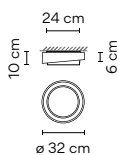

Light Source



1 x LED PLATE 15.2W 700mA.
2 x LED STRIP 4W 700mA.
LED 2700 K. CRI >80. 3372 lm. 145 lm/W.
Driver Constant Current 700 mA.
220-240V. 50/60Hz.
Dimming: 1-10V, Push.

Personalization options available

- LED 3000 K / 4000 K.
- Dimming: DALI or Casambi.
Min. quantity, upcharge and extra lead time apply.

Materials

Body: ABS.
Diffuser: Methacrylate.
Canopy: Steel.

Packaging

1 Box
0,2 x 0,41 x 0,41 m.
Vol. 0,0336 m³.
Gross weight 3,33 Kg.
Net weight 2,42 Kg.

5700 58 /1B Cream

(NCS S 2005-Y20R + NCS S 0502-Y)

5700 93 /1B White

(RAL 9010 Matt)



5710

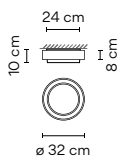

Light Source



1 x LED PLATE 15.2W 700mA.
2 x LED STRIP 4W 700mA.
LED 2700 K. CRI >80. 3372 lm. 145 lm/W.
Driver Constant Current 700 mA.
220-240V. 50/60Hz.
Dimming: 1-10V, Push.

Personalization options available

- LED 3000 K / 4000 K.
- Dimming: DALI or Casambi.
Min. quantity, upcharge and extra lead time apply.

Materials

Body: ABS.
Diffuser: Methacrylate.
Canopy: Steel.

Packaging

1 Box
0,2 x 0,41 x 0,41 m.
Vol. 0,0336 m³.
Gross weight 3,33 Kg.
Net weight 2,42 Kg.

5710 58 /1B Cream

(NCS S 2005-Y20R + NCS S 0502-Y)

5710 93 /1B White

(RAL 9010 Matt)



Tempo

Design by Lievore, Altherr

Timeless character. The Tempo collection by Lievore Altherr reclaims our collective memory of light, making it contemporary through its most essential expression. Shades with an architectonic profile recreate different ambiances bringing them right up-to-date with new additions and uses.



Ref.
5757, 5759, 5761,
5763, 5765, 5767.
Recessed dimmable
driver.

Ref.
5756, 5758, 5760,
5762, 5764, 5766.
Push dimmer on
the cable.
With plug.

Wall

5756

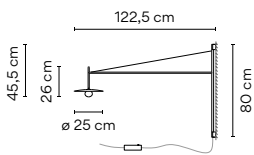

Light Source

1 x LED 4 W 350mA.
LED 2700 K. CRI >90. 440,8 lm. 110,2 lm/W.
Driver Constant Current 350 mA.
220-240V. 50/60Hz.
Dimming: Push.

Push dimmer on the cable. With plug (4 m).

Personalization options available

- Finish customization.
- (Available options: Vibia color palette).
- LED 3000 K / 4000 K.
- Min. quantity, upcharge and extra lead time apply.

Materials

Diffuser: Blown-glass.
LED support: Aluminum.
Structures: Steel.
Shade: Aluminum.

Packaging

2 Boxes
Total Vol. 0,082 m³.
Gross weight 4,3 Kg.
Net weight 2,5 Kg.

5756 18 /15 Graphite
(ADAPTA RF9913WX)

5756 35 /15 Brick
(NCS S 4040-Y70R)

5756 58 /15 Cream
(RAL 7044)

5756 62 /15 Green
(NCS S 3010-G20Y)

EAC LED IP20 CE Dimmer A+

5757

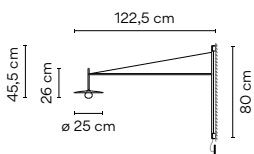

Light Source

1 x LED 4 W 350mA.
LED 2700 K. CRI >90. 440,8 lm. 110,2 lm/W.
Driver Constant Current 350 mA.
220-240V. 50/60Hz.
Dimming: 1-10V, Push.

Recessed dimmable driver (2,5 m).

Personalization options available

- Finish customization.
- (Available options: Vibia color palette).
- LED 3000 K / 4000 K.
- Dimming: DALI or Casambi.
- Min. quantity, upcharge and extra lead time apply.

Materials

Diffuser: Blown-glass.
LED support: Aluminum.
Structures: Steel.
Shade: Aluminum.

Packaging

2 Boxes
Total Vol. 0,082 m³.
Gross weight 4,3 Kg.
Net weight 2,5 Kg.

5757 18 /1B Graphite
(ADAPTA RF9913WX)

5757 35 /1B Brick
(NCS S 4040-Y70R)

5757 58 /1B Cream
(RAL 7044)

5757 62 /1B Green
(NCS S 3010-G20Y)

EAC LED IP20 CE Dimmer ø 7,5 cm A+

5758

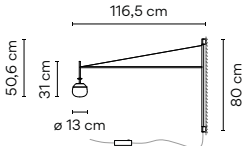

Light Source
 1 x LED 4 W 350mA.
 LED 2700 K. CRI >90. 440,8 lm. 110,2 lm/W.
 Driver Constant Current 350 mA.
 220-240V. 50/60Hz.
Dimming: Push.
 Push dimmer on the cable. With plug (4 m).

Personalization options available
 - Finish customization.
 (Available options: Vibia color palette).
 - LED 3000 K / 4000 K.
 Min. quantity, upcharge and extra lead time apply.

Materials
 Diffuser: Blown-glass.
 LED support: Aluminum.
 Structures: Steel.

Packaging
 2 Boxes
 Total Vol. 0,088 m³.
 Gross weight 3,5 Kg.
 Net weight 1,7 Kg.

5758 18 /15 Graphite (ADAPTA RF9913WX)
5758 35 /15 Brick (NCS S 4040-Y70R)
5758 58 /15 Cream (RAL 7044)
5758 62 /15 Green (NCS S 3010-G20Y)

EAC LED IP20 CE Dimmer A++

5759

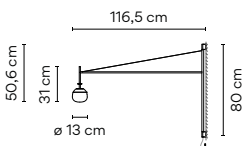

Light Source
 1 x LED 4 W 350mA.
 LED 2700 K. CRI >90. 440,8 lm. 110,2 lm/W.
 Driver Constant Current 350 mA.
 220-240V. 50/60Hz.
Dimming: 1-10V, Push.
 Recessed dimmable driver (2,5 m).

Personalization options available
 - Finish customization.
 (Available options: Vibia color palette).
 - LED 3000 K / 4000 K.
 - Dimming: DALI or Casambi.
 Min. quantity, upcharge and extra lead time apply.

Materials
 Diffuser: Blown-glass.
 LED support: Aluminum.
 Structures: Steel.

Packaging
 2 Boxes
 Total Vol. 0,088 m³.
 Gross weight 3,5 Kg.
 Net weight 1,7 Kg.

5759 18 /1B Graphite (ADAPTA RF9913WX)
5759 35 /1B Brick (NCS S 4040-Y70R)
5759 58 /1B Cream (RAL 7044)
5759 62 /1B Green (NCS S 3010-G20Y)

EAC LED IP20 CE ø 7,5 cm A++

5760

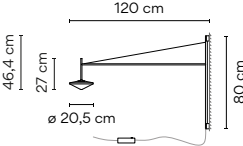

Light Source
 1 x LED 4 W 350mA.
 LED 2700 K. CRI >90. 440,8 lm. 110,2 lm/W.
 Driver Constant Current 350 mA.
 220-240V. 50/60Hz.
Dimming: Push.
 Push dimmer on the cable. With plug (4 m).

Personalization options available
 - Finish customization.
 (Available options: Vibia color palette).
 - LED 3000 K / 4000 K.
 Min. quantity, upcharge and extra lead time apply.

Materials
 Diffuser: Blown-glass.
 LED support: Aluminum.
 Structures: Steel.

Packaging
 2 Boxes
 Total Vol. 0,088 m³.
 Gross weight 3,7 Kg.
 Net weight 1,9 Kg.

5760 18 /15 Graphite (ADAPTA RF9913WX)
5760 35 /15 Brick (NCS S 4040-Y70R)
5760 58 /15 Cream (RAL 7044)
5760 62 /15 Green (NCS S 3010-G20Y)

EAC LED IP20 CE Dimmer A++

5761

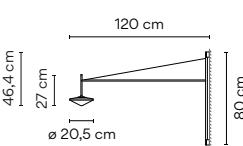

Light Source
 1 x LED 4 W 350mA.
 LED 2700 K. CRI >90. 440,8 lm. 110,2 lm/W.
 Driver Constant Current 350 mA.
 220-240V. 50/60Hz.
Dimming: 1-10V, Push.
 Recessed dimmable driver (2,5 m).

Personalization options available
 - Finish customization.
 (Available options: Vibia color palette).
 - LED 3000 K / 4000 K.
 - Dimming: DALI or Casambi.
 Min. quantity, upcharge and extra lead time apply.

Materials
 Diffuser: Blown-glass.
 LED support: Aluminum.
 Structures: Steel.

Packaging
 2 Boxes
 Total Vol. 0,088 m³.
 Gross weight 3,7 Kg.
 Net weight 1,9 Kg.

5761 18 /1B Graphite (ADAPTA RF9913WX)
5761 35 /1B Brick (NCS S 4040-Y70R)
5761 58 /1B Cream (RAL 7044)
5761 62 /1B Green (NCS S 3010-G20Y)

EAC LED IP20 CE ø 7,5 cm A++

5762

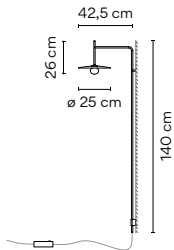

Light Source

1 x LED 4 W 350mA.
LED 2700 K. CRI >90. 440,8 lm. 110,2 lm/W.
Driver Constant Current 350 mA.
 220-240V. 50/60Hz.
Dimming: Push.

Push dimmer on the cable. With plug (4 m).

Personalization options available

- Finish customization.
 (Available options: Vibia color palette).
 - LED 3000 K / 4000 K.
- Min. quantity, upcharge and extra lead time apply.

Materials

Diffuser: Blown-glass.
 LED support: Aluminum.
 Structures: Steel.
 Shade: Aluminum.

Packaging

2 Boxes
 Total Vol. 0,088 m³.
 Gross weight 3,2 Kg.
 Net weight 2 Kg.

5762 18 /15 Graphite
 (ADAPTA RF9913WX)

5762 35 /15 Brick
 (NCS S 4040-Y70R)

5762 58 /15 Cream
 (RAL 7044)

5762 62 /15 Green
 (NCS S 3010-G20Y)

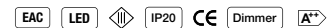

5763

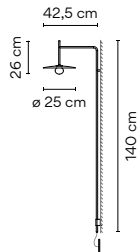

Light Source

1 x LED 4 W 350mA.
LED 2700 K. CRI >90. 440,8 lm. 110,2 lm/W.
Driver Constant Current 350 mA.
 220-240V. 50/60Hz.
Dimming: 1-10V, Push.

Recessed dimmable driver (2,5 m).

Personalization options available

- Finish customization.
 (Available options: Vibia color palette).
 - LED 3000 K / 4000 K.
 - Dimming: DALI or Casambi.
- Min. quantity, upcharge and extra lead time apply.

Materials

Diffuser: Blown-glass.
 LED support: Aluminum.
 Structures: Steel.
 Shade: Aluminum.

Packaging

2 Boxes
 Total Vol. 0,088 m³.
 Gross weight 3,2 Kg.
 Net weight 2 Kg.

5763 18 /1B Graphite
 (ADAPTA RF9913WX)

5763 35 / 1B Brick
 (NCS S 4040-Y70R)

5763 58 /1B Cream
 (RAL 7044)

5763 62 /1B Green
 (NCS S 3010-G20Y)

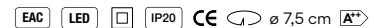

5764

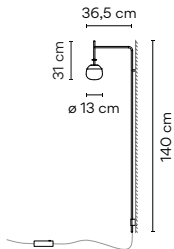

Light Source

1 x LED 4 W 350mA.
LED 2700 K. CRI >90. 440,8 lm. 110,2 lm/W.
Driver Constant Current 350 mA.
 220-240V. 50/60Hz.
Dimming: Push.

Push dimmer on the cable. With plug (4 m).

Personalization options available

- Finish customization.
 (Available options: Vibia color palette).
 - LED 3000 K / 4000 K.
- Min. quantity, upcharge and extra lead time apply.

Materials

Diffuser: Blown-glass.
 LED support: Aluminum.
 Structures: Steel.

Packaging

2 Boxes
 Total Vol. 0,088 m³.
 Gross weight 2,45 Kg.
 Net weight 1,25 Kg.

5764 18 /15 Graphite
 (ADAPTA RF9913WX)

5764 35 /15 Brick
 (NCS S 4040-Y70R)

5764 58 /15 Cream
 (RAL 7044)

5764 62 /15 Green
 (NCS S 3010-G20Y)

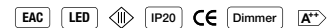

5765

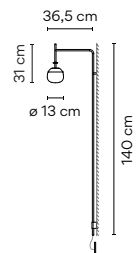

Light Source

1 x LED 4 W 350mA.
LED 2700 K. CRI >90. 440,8 lm. 110,2 lm/W.
Driver Constant Current 350 mA.
 220-240V. 50/60Hz.
Dimming: 1-10V, Push.

Recessed dimmable driver (2,5 m).

Personalization options available

- Finish customization.
 (Available options: Vibia color palette).
 - LED 3000 K / 4000 K.
 - Dimming: DALI or Casambi.
- Min. quantity, upcharge and extra lead time apply.

Materials

Diffuser: Blown-glass.
 LED support: Aluminum.
 Structures: Steel.

Packaging

2 Boxes
 Total Vol. 0,088 m³.
 Gross weight 2,45 Kg.
 Net weight 1,25 Kg.

5765 18 /1B Graphite
 (ADAPTA RF9913WX)

5765 35 /1B Brick
 (NCS S 4040-Y70R)

5765 58 /1B Cream
 (RAL 7044)

5765 62 /1B Green
 (NCS S 3010-G20Y)



5766

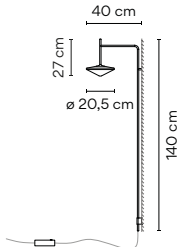

Light Source

1 x LED 4 W 350mA.
LED 2700 K. CRI >90. 440,8 lm. 110,2 lm/W.
Driver Constant Current 350 mA.
 220-240V. 50/60Hz.
Dimming: Push.

Push dimmer on the cable. With plug (4 m).

Personalization options available

- Finish customization.
 (Available options: Vibia color palette).
 - LED 3000 K / 4000 K.
- Min. quantity, upcharge and extra lead time apply.

Materials

Diffuser: Blown-glass.
 LED support: Aluminum.
 Structures: Steel.

Packaging

2 Boxes
 Total Vol. 0,088 m³.
 Gross weight 2,65 Kg.
 Net weight 1,45 Kg.

5766 18 /15 Graphite
 (ADAPTA RF9913WX)

5766 35 /15 Brick
 (NCS S 4040-Y70R)

5766 58 /15 Cream
 (RAL 7044)

5766 62 /15 Green
 (NCS S 3010-G20Y)

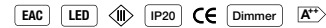

5767

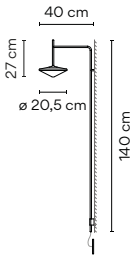

Light Source

1 x LED 4 W 350mA.
LED 2700 K. CRI >90. 440,8 lm. 110,2 lm/W.
Driver Constant Current 350 mA.
 220-240V. 50/60Hz.
Dimming: 1-10V, Push.

Recessed dimmable driver (2,5 cm).

Personalization options available

- Finish customization.
 (Available options: Vibia color palette).
 - LED 3000 K / 4000 K.
 - Dimming: DALI or Casambi.
- Min. quantity, upcharge and extra lead time apply.

Materials

Diffuser: Blown-glass.
 LED support: Aluminum.
 Structures: Steel.

Packaging

2 Boxes
 Total Vol. 0,088 m³.
 Gross weight 2,65 Kg.
 Net weight 1,45 Kg.

5767 18 /1B Graphite
 (ADAPTA RF9913WX)

5767 35 /1B Brick
 (NCS S 4040-Y70R)

5767 58 /1B Cream
 (RAL 7044)

5767 62 /1B Green
 (NCS S 3010-G20Y)



Pendants

5770

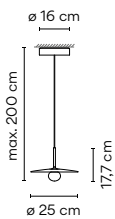

Light Source

1 x LED 4 W 350mA.
LED 2700 K. CRI >90. 550 lm. 137,50 lm/W.
Driver Constant Current 350 mA.
 110-240V. 50/60Hz.
Dimming: 1-10V, Push.

Personalization options available

- Finish customization.
 (Available options: Vibia color palette).
 - LED 3000 K / 4000 K.
 - Dimming: DALI or Casambi.
 - Extra cable length.
- Min. quantity, upcharge and extra lead time apply.

Materials

Diffuser: Blown-glass.
 LED support: Aluminum.
 Structures: Steel.
 Shade: Aluminum.
 Canopy: Steel.

Packaging

1 Box
 0,28 x 0,26 x 0,13 m.
 Vol. 0,01 m³.
 Gross weight 2,5 Kg.
 Net weight 2 Kg.

5770 18 /1B Graphite
 (ADAPTA RF9913WX)

5770 35 /1B Brick
 (NCS S 4040-Y70R)

5770 58 /1B Cream
 (RAL 7044)

5770 62 /1B Green
 (NCS S 3010-G20Y)



5772

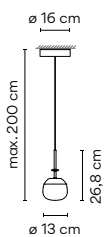

Light Source

1 x LED 4 W 350mA.
LED 2700 K. CRI >90. 550 lm. 137,50 lm/W.
Driver Constant Current 350 mA.
 110-240V. 50/60Hz.
Dimming: 1-10V, Push.

Personalization options available

- Finish customization.
 (Available options: Vibia color palette).
 - LED 3000 K / 4000 K.
 - Dimming: DALI or Casambi.
 - Extra cable length.
- Min. quantity, upcharge and extra lead time apply.

Materials

Diffuser: Blown-glass.
 LED support: Aluminum.
 Structure: Steel.
 Canopy: Steel.

Packaging

1 Box
 0,28 x 0,2 x 0,27 m.
 Vol. 0,015 m³.
 Gross weight 1,8 Kg.
 Net weight 1,2 Kg.

5772 18 /1B Graphite
 (ADAPTA RF9913WX)

5772 35 /1B Brick
 (NCS S 4040-Y70R)

5772 58 /1B Cream
 (RAL 7044)

5772 62 /1B Green
 (NCS S 3010-G20Y)

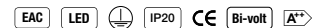

5774

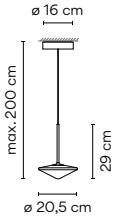

Light Source

1 x LED 4 W 350mA.
LED 2700 K. CRI >90. 550 lm. 137,50 lm/W.
Driver Constant Current 350 mA.
 110-240V. 50/60Hz.
Dimming: 1-10V, Push.

Personalization options available

- Finish customization. (Available options: Vibia color palette).
- LED 3000 K / 4000 K.
- Dimming: DALI or Casambi.
- Extra cable length.
- Min. quantity, upcharge and extra lead time apply.

Materials

Diffuser: Blown-glass.
 LED support: Aluminum.
 Structure: Steel.
 Canopy: Steel.

Packaging

1 Box
 0,28 x 0,2 x 0,27 m.
 Vol. 0,015 m³.
 Gross weight 2 Kg.
 Net weight 1,4 Kg.

5774 18 /1B Graphite
 (ADAPTA RF9913WX)

5774 35 /1B Brick
 (NCS S 4040-Y70R)

5774 58 /1B Cream
 (RAL 7044)

5774 62 /1B Green
 (NCS S 3010-G20Y)



5776

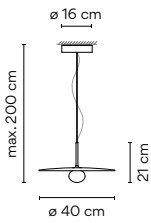

Light Source

1 x LED 4 W 350mA.
LED 2700 K. CRI >90. 550 lm. 137,50 lm/W.
Driver Constant Current 350 mA.
 110-240V. 50/60Hz.
Dimming: 1-10V, Push.

Personalization options available

- Finish customization. (Available options: Vibia color palette).
- LED 3000 K / 4000 K.
- Dimming: DALI or Casambi.
- Extra cable length.
- Min. quantity, upcharge and extra lead time apply.

Materials

Diffuser: Blown-glass.
 LED support: Aluminum.
 Structures: Steel.
 Shade: Aluminum.
 Canopy: Steel.

Packaging

1 Box
 0,45 x 0,45 x 0,12 m.
 Vol. 0,023 m³.
 Gross weight 5,5 Kg.
 Net weight 4 Kg.

5776 18 /1B Graphite
 (ADAPTA RF9913WX)

5776 35 /1B Brick
 (NCS S 4040-Y70R)

5776 58 /1B Cream
 (RAL 7044)

5776 62 /1B Green
 (NCS S 3010-G20Y)



5778

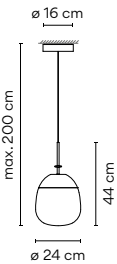

Light Source

1 x LED 4 W 350mA.
LED 2700 K. CRI >90. 550 lm. 137,50 lm/W.
Driver Constant Current 350 mA.
 110-240V. 50/60Hz.
Dimming: 1-10V, Push.

Personalization options available

- Finish customization. (Available options: Vibia color palette).
- LED 3000 K / 4000 K.
- Dimming: DALI or Casambi.
- Extra cable length.
- Min. quantity, upcharge and extra lead time apply.

Materials

Diffuser: Blown-glass.
 LED support: Aluminum.
 Structure: Steel.
 Canopy: Steel.

Packaging

1 Box
 0,33 x 0,33 x 0,42 m.
 Vol. 0,045 m³.
 Gross weight 4 Kg.
 Net weight 2,5 Kg.

5778 18 /1B Graphite
 (ADAPTA RF9913WX)

5778 35 /1B Brick
 (NCS S 4040-Y70R)

5778 58 /1B Cream
 (RAL 7044)

5778 62 /1B Green
 (NCS S 3010-G20Y)



5780

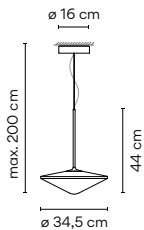

Light Source

1 x LED 4 W 350mA.
LED 2700 K. CRI >90. 550 lm. 137,50 lm/W.
Driver Constant Current 350 mA.
 110-240V. 50/60Hz.
Dimming: 1-10V, Push.

Personalization options available

- Finish customization. (Available options: Vibia color palette).
- LED 3000 K / 4000 K.
- Dimming: DALI or Casambi.
- Extra cable length.
- Min. quantity, upcharge and extra lead time apply.

Materials

Diffuser: Blown-glass.
 LED support: Aluminum.
 Structure: Steel.
 Canopy: Steel.

Packaging

1 Box
 0,41 x 0,41 x 0,23 m.
 Vol. 0,038 m³.
 Gross weight 4 Kg.
 Net weight 2,5 Kg.

5780 18 /1B Graphite
 (ADAPTA RF9913WX)

5780 35 /1B Brick
 (NCS S 4040-Y70R)

5780 58 /1B Cream
 (RAL 7044)

5780 62 /1B Green
 (NCS S 3010-G20Y)



Suite

Design by Jordi Vilardell & Meritxell Vidal

Reinterprets and updates the traditional combination of side table or shelf with table lamp. Its warm and comfortable lighting effect appears when least expected, a pleasant luminous surprise.



Floor

6005

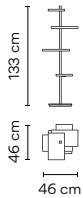

Light Source

8 x LED STRIP 24V 1,63W.
LED 2700 K. CRI >80. 1054,7 lm. 81 lm/W.
Driver Constant Voltage 24V.
220-240V. 50Hz.

USB charging connection.
LED on/off switch under the shelf.
Electric cable 2,5 m.

Personalization options available

- Finish customization.
(Available options: Vibia color palette).
- LED 3000 K / 4000 K.

Min. quantity, upcharge and extra lead time apply.

Materials

Shelf: Aluminum.
Diffuser: Polycarbonate.
Vertical tube: Steel.
Base: Steel.
Lid: ABS with fiberglass.

Packaging

1 Box
0,730 x 0,535 x 1,385 m.
Vol. 0,4513 m³.
Gross weight 34,1 Kg.
Net weight 16,5 Kg.

6005 14 /10 Chocolate
(RAL 8019)

6005 93 /10 White
(RAL 9016)



6006

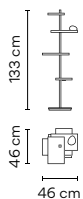

Light Source

8 x LED STRIP 24V 1,63W.
1 x LED 4,5W 350mA.
LED 2700 K. CRI >80. 1545 lm. 88 lm/W.
Driver Constant Current / Constant Voltage 350 mA. 24V. 220-240V. 50Hz.
Dimming: Push.

Glass diffuser mounted on shelf with dimmable light.
USB charging connection.
LED on/off switch under the shelf.
Electric cable 2,5 m.

Personalization options available

- Finish customization.
(Available options: Vibia color palette).
- LED 3000 K / 4000 K.

Min. quantity, upcharge and extra lead time apply.

Materials

Shelf: Aluminum.
Diffuser: Polycarbonate.
Vertical tube: Steel.
Base: Steel.
Lid: ABS with fiberglass.

Packaging

1 Box
0,730 x 0,535 x 1,385 m.
Vol. 0,4513 m³.
Gross weight 34,3 Kg.
Net weight 16,7 Kg.

6006 14 /15 Chocolate
(RAL 8019)

6006 93 /15 White
(RAL 9016)

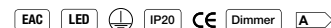

6007

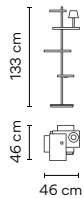
**Light Source**

8 x LED STRIP 24V 1,63W.
1 x LED 4,5W 350mA.
LED 2700 K. CRI >80. 1545 lm. 88 lm/W.
Driver Constant Current / Constant Voltage 350 mA. 24V. 220-240V. 50Hz.
Dimming: Push.

Reading light mink (Pantone 407C), mounted on shelf with dimmable light. USB charging connection. LED on/off switch under the shelf. Electric cable 2,5 m.

Personalization options available

- Finish customization.
(Available options: Vibia color palette).
- LED 3000 K / 4000 K.
Min. quantity, upcharge and extra lead time apply.

Materials

Shelf: Aluminum.
Diffuser: Polycarbonate.
Vertical tube: Steel.
Base: Steel.
Lid: ABS with fiberglass.

Packaging

1 Box
0,730 x 0,535 x 1,385 m.
Vol. 0,4513 m³.
Gross weight 34,3 Kg.
Net weight 17 Kg.

6007 14 /15 Chocolate
(RAL 8019)

6007 93 /15 White
(RAL 9016)

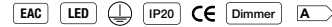

6010

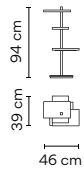
**Light Source**

6 x LED STRIP 24V 1,63W.
LED 2700 K. CRI >80. 791 lm. 81 lm/W.
Driver Constant Voltage 24V.
220-240V. 50Hz.

USB charging connection.
LED on/off switch under the shelf.
Electric cable 2,5 m.

Personalization options available

- Finish customization.
(Available options: Vibia color palette).
- LED 3000 K / 4000 K.
Min. quantity, upcharge and extra lead time apply.

Materials

Shelf: Aluminum.
Diffuser: Polycarbonate.
Vertical tube: Steel.
Base: Steel.
Lid: ABS with fiberglass.

Packaging

1 Box
0,730 x 0,535 x 1,385 m.
Vol. 0,3623 m³.
Gross weight 32,3 Kg.
Net weight 15,5 Kg.

6010 14 /10 Chocolate
(RAL 8019)

6010 93 /10 White
(RAL 9016)

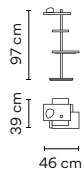

6011

**Light Source**

6 x LED STRIP 24V 1,63W.
1 x LED 4,5W 350mA.
LED 2700 K. CRI >80. 1281 lm. 88 lm/W.
Driver Constant Current / Constant Voltage 350 mA. 24V. 220-240V. 50Hz.
Dimming: Push.

Glass diffuser mounted on shelf with dimmable light. USB charging connection. LED on/off switch under the shelf. Electric cable 2,5 m.

Personalization options available

- Finish customization.
(Available options: Vibia color palette).
- LED 3000 K / 4000 K.
Min. quantity, upcharge and extra lead time apply.

Materials

Shelf: Aluminum.
Diffuser: Polycarbonate.
Vertical tube: Steel.
Base: Steel.
Lid: ABS with fiberglass.

Packaging

1 Box
0,730 x 0,535 x 1,385 m.
Vol. 0,3623 m³.
Gross weight 32,4 Kg.
Net weight 15,7 Kg.

6011 14 /15 Chocolate
(RAL 8019)

6011 93 /15 White
(RAL 9016)

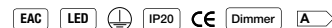

6012

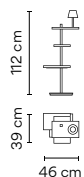
**Light Source**

6 x LED STRIP 24V 1,63W.
1 x LED 4,5W 350mA.
LED 2700 K. CRI >80. 1281 lm. 88 lm/W.
Driver Constant Current / Constant Voltage 350 mA. 24V. 220-240V. 50Hz.
Dimming: Push.

Reading light mink (Pantone 407C), mounted on shelf with dimmable light. USB charging connection. LED on/off switch under the shelf. Electric cable 2,5 m.

Personalization options available

- Finish customization.
(Available options: Vibia color palette).
- LED 3000 K / 4000 K.
Min. quantity, upcharge and extra lead time apply.

Materials

Shelf: Aluminum.
Diffuser: Polycarbonate.
Vertical tube: Steel.
Base: Steel.
Lid: ABS with fiberglass.

Packaging

1 Box
0,730 x 0,535 x 1,385 m.
Vol. 0,4513 m³.
Gross weight 33,6 Kg.
Net weight 16 Kg.

6012 14 /15 Chocolate
(RAL 8019)

6012 93 /15 White
(RAL 9016)

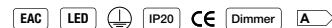

Table

6025

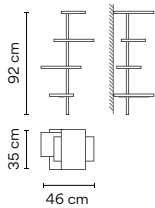

Light Source

8 x LED STRIP 24V 1,63W.
LED 2700 K. CRI >80. 1055 lm. 81 lm/W.
Driver Constant Voltage 24V.
 220-240V. 50Hz.

USB charging connection.
 LED on/off switch under the shelf.
 Electric cable 2,5 m.

Personalization options available

- Finish customization.
 (Available options: Vibia color palette).
 - LED 3000 K / 4000 K.
 Min. quantity, upcharge and extra lead time apply.

Materials

Shelf: Aluminum.
 Diffuser: Polycarbonate.
 Vertical tube: Steel.
 Lid: ABS with fiberglass.

Packaging

1 Box
 0,61 x 0,54 x 1,1 m.
 Vol. 0,3623 m³.
 Gross weight 11 Kg.
 Net weight 5,6 Kg.

6025 14 /10 Chocolate
 (RAL 8019)

6025 93 /10 White
 (RAL 9016)



6026

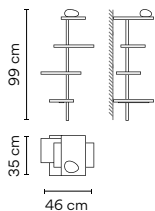

Light Source

8 x LED STRIP 24V 1,63W.
 1 x LED 4,5W 350mA.
LED 2700 K. CRI >80. 1545 lm. 88 lm/W.
Driver Constant Current / Constant
 Voltage 350 mA. 24V. 220-240V. 50Hz.
Dimming: Push.

Glass diffuser mounted
 on shelf with dimmable light.
 USB charging connection.
 LED on/off switch under the shelf.
 Electric cable 2,5 m.

Personalization options available

- Finish customization.
 (Available options: Vibia color palette).
 - LED 3000 K / 4000 K.
 Min. quantity, upcharge and extra lead time apply.

Materials

Shelf: Aluminum.
 Diffuser: Polycarbonate.
 Vertical tube: Steel.
 Lid: ABS with fiberglass.

Packaging

1 Box
 0,61 x 0,54 x 1,1 m.
 Vol. 0,3623 m³.
 Gross weight 11,2 Kg.
 Net weight 5,8 Kg.

6026 14 /15 Chocolate
 (RAL 8019)

6026 93 /15 White
 (RAL 9016)

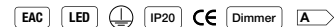

6027

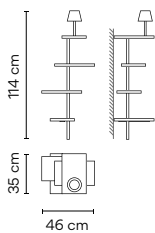

Light Source

8 x LED STRIP 24V 1,63W.
 1 x LED 4,5W 350mA.
LED 2700 K. CRI >80. 1545 lm. 88 lm/W.
Driver Constant Current / Constant
 Voltage 350 mA. 24V. 220-240V. 50Hz.
Dimming: Push.

Reading light mink (Pantone 407C),
 mounted on shelf with dimmable light.
 USB charging connection.
 LED on/off switch under the shelf.
 Electric cable 2,5 m.

Personalization options available

- Finish customization.
 (Available options: Vibia color palette).
 - LED 3000 K / 4000 K.
 Min. quantity, upcharge and extra lead time apply.

Materials

Shelf: Aluminum.
 Diffuser: Polycarbonate.
 Vertical tube: Steel.
 Lid: ABS with fiberglass.

Packaging

1 Box
 0,61 x 0,54 x 1,37 m.
 Vol. 0,4513 m³.
 Gross weight 12,4 Kg.
 Net weight 6,1 Kg.

6027 14 /15 Chocolate
 (RAL 8019)

6027 93 /15 White
 (RAL 9016)

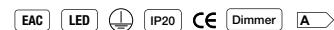

6030

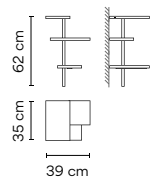

Light Source

6 x LED STRIP 24V 1,63W.
LED 2700 K. CRI >80. 791 lm. 81 lm/W.
Driver Constant Voltage 24V.
 220-240V. 50Hz.

USB charging connection.
 LED on/off switch under the shelf.
 Electric cable 2,5 m.

Personalization options available

- Finish customization.
 (Available options: Vibia color palette).
 - LED 3000 K / 4000 K.
 Min. quantity, upcharge and extra lead time apply.

Materials

Shelf: Aluminum.
 Diffuser: Polycarbonate.
 Vertical tube: Steel.
 Lid: ABS with fiberglass.

Packaging

1 Box
 0,61 x 0,54 x 1,1 m.
 Vol. 0,3623 m³.
 Gross weight 9,8 Kg.
 Net weight 4,4 Kg.

6030 14 /10 Chocolate
 (RAL 8019)

6030 93 /10 White
 (RAL 9016)



6031

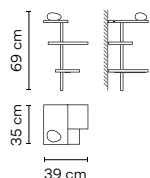

Light Source

6 x LED STRIP 24V 1,63W.
1 x LED 4,5W 350mA.
LED 2700 K. CRI >80. 1281 lm. 88 lm/W.
Driver Constant Current / Constant Voltage 350 mA. 24V. 220-240V. 50Hz.
Dimming: Push.

Glass diffuser mounted on shelf with dimmable light.
USB charging connection.
LED on/off switch under the shelf.
Electric cable 2,5 m.

Personalization options available

- Finish customization.
(Available options: Vibia color palette).
 - LED 3000 K / 4000 K.
- Min. quantity, upcharge and extra lead time apply.

Materials

Shelf: Aluminum.
Diffuser: Polycarbonate.
Vertical tube: Steel.
Lid: ABS with fiberglass.

Packaging

1 Box
0,61 x 0,54 x 1,1 m.
Vol. 0,3623 m³.
Gross weight 10 Kg.
Net weight 4,6 Kg.

6031 14 /15 Chocolate
(RAL 8019)

6031 93 /15 White
(RAL 9016)

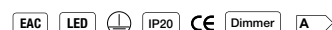

6032

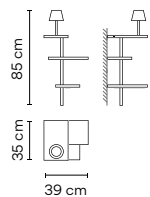

Light Source

6 x v LED STRIP 24V 1,63W.
1 x LED 4,5W 350mA.
LED 2700 K. CRI >80. 1281 lm. 88 lm/W.
Driver Constant Current / Constant Voltage 350 mA. 24V. 220-240V. 50Hz.
Dimming: Push.

Reading light mink (Pantone 407C), mounted on shelf with dimmable light.
USB charging connection.
LED on/off switch under the shelf.
Electric cable 2,5 m.

Personalization options available

- Finish customization.
(Available options: Vibia color palette).
 - LED 3000 K / 4000 K.
- Min. quantity, upcharge and extra lead time apply.

Materials

Shelf: Aluminum.
Diffuser: Polycarbonate.
Vertical tube: Steel.
Lid: ABS with fiberglass.

Packaging

1 Box
0,61 x 0,54 x 1,1 m.
Vol. 0,3623 m³.
Gross weight 10,3 Kg.
Net weight 4,9 Kg.

6032 14 /15 Chocolate
(RAL 8019)

6032 93 /15 White
(RAL 9016)

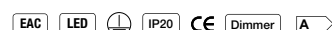

Wall

6035

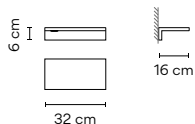

Light Source

1 x LED STRIP 24V 1,63W.
LED 2700 K. CRI >80. 132 lm. 81 lm/W.
Driver Constant Voltage 24V. 220-240V. 50Hz.

Personalization options available

- Finish customization.
(Available options: Vibia color palette).
 - LED 3000 K / 4000 K.
- Min. quantity, upcharge and extra lead time apply.

Materials

Shelf: Aluminum.
Diffuser: Polycarbonate.
Lid: Steel.

Packaging

1 Box
0,11 x 0,25 x 0,46 m.
Vol. 0,0126 m³.
Gross weight 1,8 Kg.
Net weight 1,5 Kg.

6035 14 /10 Chocolate
(RAL 8019)

6035 93 /10 White
(RAL 9016)



6040

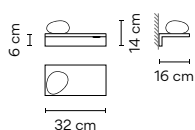

Light Source

1 x LED 4,5W 350mA.
LED 2700 K. CRI >80. 490 lm. 109 lm/W.
Driver Constant Current 350 mA. 220-240V. 50Hz.

Personalization options available

- Finish customization.
(Available options: Vibia color palette).
 - LED 3000 K / 4000 K.
- Min. quantity, upcharge and extra lead time apply.

Materials

Shelf: Aluminum.
Diffuser: Blown-glass.
Lid: Steel.

Packaging

1 Box
0,29 x 0,38 x 0,38 m.
Vol. 0,418 m³.
Gross weight 2,6 Kg.
Net weight 1,6 Kg.

6040 14 /10 Chocolate
(RAL 8019)

6040 93 /10 White
(RAL 9016)

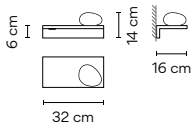

6041

**Light Source**

1 x LED 4,5W 350mA.
LED 2700 K. CRI >80. 490 lm. 109 lm/W.
Driver Constant Current 350 mA.
 220-240V. 50Hz.

Personalization options available

- Finish customization.
 (Available options: Vibia color palette).
 - LED 3000 K / 4000 K.
 Min. quantity, upcharge and extra lead time apply.

Materials

Shelf: Aluminum.
 Diffuser: Blown-glass.
 Lid: Steel.

Packaging

1 Box
 0,29 x 0,38 x 0,38 m.
 Vol. 0,418 m³.
 Gross weight 2,6 Kg.
 Net weight 1,6 Kg.

6041 14 /10 Chocolate
 (RAL 8019)

6041 93 /10 White
 (RAL 9016)

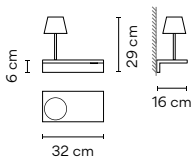

6045

**Light Source**

1 x LED STRIP 24V 1,63W.
 1 x LED 4,5W 350mA.
LED 2700 K. CRI >80. 622 lm. 101 lm/W.
Driver Constant Current / Constant
 Voltage 350 mA. 24V. 200-240V. 50Hz.

LED on/off switch on the bottom cover.
 Reading light mink (Pantone 407C),
 mounted on shelf.

Personalization options available

- Finish customization.
 (Available options: Vibia color palette).
 - LED 3000 K / 4000 K.
 Min. quantity, upcharge and extra lead time apply.

Materials

Shelf: Aluminum.
 Diffuser: Polycarbonate.
 Lid: Steel.

Packaging

1 Box
 0,29 x 0,38 x 0,38 m.
 Vol. 0,418 m³.
 Gross weight 2,6 Kg.
 Net weight 1,8 Kg.

6045 14 /10 Chocolate
 (RAL 8019)

6045 93 /10 White
 (RAL 9016)

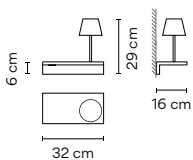

6046

**Light Source**

1 x LED STRIP 24V 1,63W.
 1 x LED 4,5W 350mA.
LED 2700 K. CRI >80. 622 lm. 101 lm/W.
Driver Constant Current / Constant
 Voltage 350 mA. 24V. 200-240V. 50Hz.

LED on/off switch on the bottom cover.
 Reading light mink (Pantone 407C),
 mounted on shelf.

Personalization options available

- Finish customization.
 (Available options: Vibia color palette).
 - LED 3000 K / 4000 K.
 Min. quantity, upcharge and extra lead time apply.

Materials

Shelf: Aluminum.
 Diffuser: Polycarbonate.
 Lid: Steel.

Packaging

1 Box
 0,29 x 0,38 x 0,38 m.
 Vol. 0,418 m³.
 Gross weight 2,6 Kg.
 Net weight 1,8 Kg.

6046 14 /10 Chocolate
 (RAL 8019)

6046 93 /10 White
 (RAL 9016)

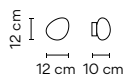

6050

**Light Source**

1 x LED 4,5W 350mA.
LED 2700K. CRI >80. 490 lm. 109 lm/W.
Driver Constant Current 350 mA.
 100-240V. 50/60Hz.

Personalization options available

- LED 3000 K / 4000 K.
 Min. quantity, upcharge and extra lead time apply.

Materials

Body: Aluminum.
 Diffuser: Blown-glass.

Packaging

1 Box
 0,13 x 0,20 x 0,21 m.
 Vol. 0,00055 m³.
 Gross weight 0,6 Kg.
 Net weight 0,4 Kg.

6050 93 /10 White
 (RAL 9016)



Tube

Design by Ichiro Iwasaki

Shade Landscape. A fluid gesture outlines the tubes, which when set out over a space become the structure that facilitates a meeting of the shades in a harmonious coming together.



Create your product configuration quickly and easily at vibia.com

Go to vibia.com and discover the quickest, most efficient way to configure a unique Tube design.

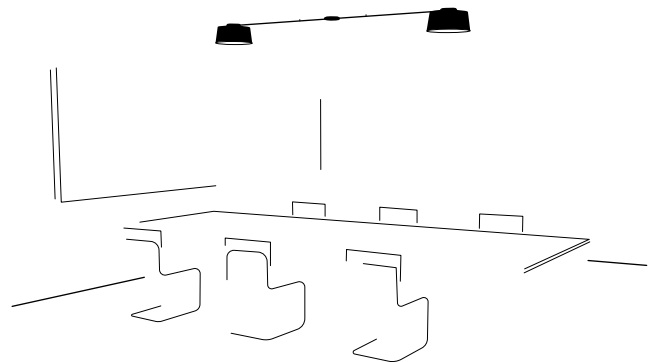
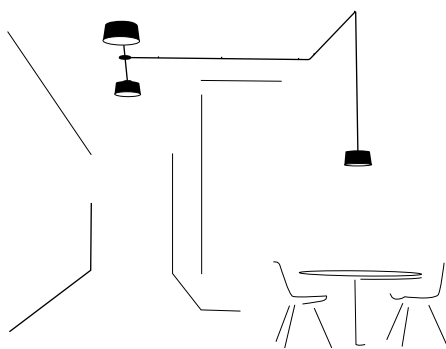

Ceiling

6100

New

Light Source

1 x LED PLATE 13,5W 700mA.
LED 2700 K. CRI >90. 1740 lm. 128,9 lm/W.
Driver Constant Current 700 mA.
110-240V. 50/60Hz.
Dimming: DALI, 1-10V, Push.

Personalization options available
- Configuration layout at vibia.com
- LED 3000 K / 4000 K.
Min. quantity, upcharge and extra lead time apply.

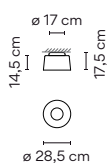

Materials

Diffuser: Polycarbonate
LED support: Aluminum
Shade: Aluminum
Canopy: Steel.

Packaging

1 Box
0,40 x 0,40 x 0,35 m.
Vol. 0,056 m³.
Gross weight 4,5 Kg.
Net weight 2,5 Kg.

6100 10 /1A White

(NCS S 0300-N)

6100 15 /1A Grey L2

(NCS S 2500-N)

6100 16 /1A Grey M1

(NCS S 4500-N)

6100 21 /1A Grey D1

(NCS S 7000-N)

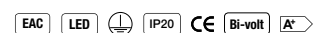

Tube

6105 New **Light Source**

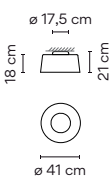

1 x LED PLATE 20W 700mA.
LED 2700 K. CRI >90. 2900 lm. 145 lm/W.
Driver Constant Current 700 mA.
 110-240V. 50/60Hz.
Dimming: DALI, 1-10V, Push.

Personalization options available
 - Configuration layout at vibia.com
 - LED 3000 K / 4000 K.
 Min. quantity, upcharge and extra lead time apply.

Materials
 Diffuser: Polycarbonate
 LED support: Aluminum
 Shade: Aluminum
 Canopy: Steel.

Packaging
 1 Box
 0,60 x 0,60 x 0,40 m.
 Vol. 0,144 m³.
 Gross weight 5,5 Kg.
 Net weight 3,5 Kg.

6105 10 /1A White (NCS S 0300-N)
6105 15 /1A Grey L2 (NCS S 2500-N)
6105 16 /1A Grey M1 (NCS S 4500-N)
6105 21 /1A Grey D1 (NCS S 7000-N)

EAC LED IP20 CE Bi-volt A+

6110 New **Light Source**

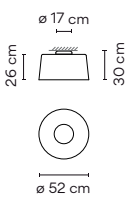

1 x LED PLATE 25W 700mA.
LED 2700 K. CRI >90. 3480 lm. 139,2 lm/W.
Driver Constant Current 700 mA.
 110-240V. 50/60Hz.
Dimming: DALI, 1-10V, Push.

Personalization options available
 - Configuration layout at vibia.com
 - LED 3000 K / 4000 K.
 Min. quantity, upcharge and extra lead time apply.

Materials
 Diffuser: Polycarbonate
 LED support: Aluminum
 Shade: Aluminum
 Canopy: Steel.

Packaging
 1 Box
 0,60 x 0,60 x 0,40 m.
 Vol. 0,144 m³.
 Gross weight 6,5 Kg.
 Net weight 4,5 Kg.

6110 10 /1A White (NCS S 0300-N)
6110 15 /1A Grey L2 (NCS S 2500-N)
6110 16 /1A Grey M1 (NCS S 4500-N)
6110 21 /1A Grey D1 (NCS S 7000-N)

EAC LED IP20 CE Bi-volt A+

6115 New **Light Source**

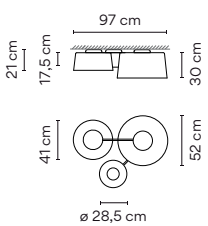

1 x LED PLATE 13,5W 700mA.
 1 x LED PLATE 20W 700mA.
 1 x LED PLATE 25W 700mA.
LED 2700 K. CRI >90. 8120 lm. 138,8 lm/W.
Driver Constant Current 700 mA.
 110-240V. 50/60Hz.
Dimming: DALI, 1-10V, Push.

Require only one electrical connection on the big shade.

Personalization options available
 - LED 3000 K / 4000 K.
 Min. quantity, upcharge and extra lead time apply.

Materials
 Diffuser: Polycarbonate
 LED support: Aluminum
 Shade: Aluminum
 Canopy: Steel.

Packaging
 1 Box
 1 x 1 x 0,40 m.
 Vol. 0,40 m³.
 Gross weight 16 Kg.
 Net weight 12 Kg.

6115 10 /1A White (NCS S 0300-N)
6115 71 /1A Grey L2, Grey M1, Grey D1 (NCS S 2500-N, NCS S 4500-N, NCS S 7000-N)

EAC LED IP20 CE Bi-volt A+

Pendants

6120 New **Light Source**

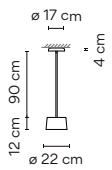

1 x LED PLATE 10,5W 700mA.
LED 2700 K. CRI >90. 1450 lm. 138 lm/W.
Driver Constant Current 700 mA.
 110-240V. 50/60Hz.
Dimming: DALI, 1-10V, Push.

Personalization options available
 - Configuration layout at vibia.com
 - LED 3000 K / 4000 K.
 Min. quantity, upcharge and extra lead time apply.

Materials
 Diffuser: Polycarbonate
 Shade: Aluminum
 Led support: Aluminum
 Tube: Steel
 Canopy: Steel.

Packaging
 2 Boxes
 Total Vol. 0,1548 m³.
 Gross weight 6 Kg.
 Net weight 3 Kg.

6120 10 /1A White (NCS S 0300-N)
6120 15 /1A Grey L2 (NCS S 2500-N)
6120 16 /1A Grey M1 (NCS S 4500-N)
6120 21 /1A Grey D1 (NCS S 7000-N)

EAC LED IP20 CE Dimmer Bi-volt A+

Tube

6125

New

Light Source



1 x LED PLATE 13,5W 700mA.
LED 2700 K. CRI >90. 1740 lm. 128,9 lm/W.
Driver Constant Current 700 mA.
110-240V. 50/60Hz.
Dimming: DALI, 1-10V, Push.

Personalization options available

- Configuration layout at vibia.com
- LED 3000 K / 4000 K.
Min. quantity, upcharge and extra lead time apply.

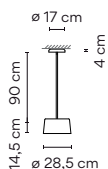

Materials

Diffuser: Polycarbonate
Shade: Aluminum
Led support: Aluminum.
Tube: Steel.
Canopy: Steel.

Packaging

2 Boxes
Total Vol. 0,1548 m³.
Gross weight 6,5 Kg.
Net weight 3,5 Kg.

6125 10 /1A White
(NCS S 0300-N)

6125 15 /1A Grey L2
(NCS S 2500-N)

6125 16 /1A Grey M1
(NCS S 4500-N)

6125 21 /1A Grey D1
(NCS S 7000-N)



6130

New

Light Source



1 x LED PLATE 20W 700mA.
LED 2700 K. CRI >90. 2900 lm. 145 lm/W.
Driver Constant Current 700 mA.
110-240V. 50/60Hz.
Dimming: DALI, 1-10V, Push.

Personalization options available

- Configuration layout at vibia.com
- LED 3000 K / 4000 K.
Min. quantity, upcharge and extra lead time apply.

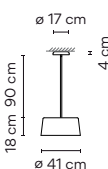

Materials

Diffuser: Polycarbonate
Shade: Aluminum
Led support: Aluminum.
Tube: Steel.
Canopy: Steel.

Packaging

2 Boxes
Total Vol. 0,256 m³.
Gross weight 8,5 Kg.
Net weight 4,5 Kg.

6130 10 /1A White
(NCS S 0300-N)

6130 15 /1A Grey L2
(NCS S 2500-N)

6130 16 /1A Grey M1
(NCS S 4500-N)

6130 21 /1A Grey D1
(NCS S 7000-N)

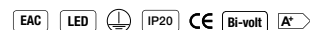

6135

New

Light Source



1 x LED PLATE 25W 700mA.
LED 2700 K. CRI >90. 4350 lm. 139,2 lm/W.
Driver Constant Current 700 mA.
110-240V. 50/60Hz.
Dimming: DALI, 1-10V, Push.

Personalization options available

- Configuration layout at vibia.com
- LED 3000 K / 4000 K.
Min. quantity, upcharge and extra lead time apply.

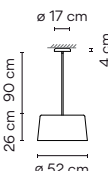

Materials

Led support: Aluminum.
Tube: Steel.
Canopy: Steel.

Packaging

2 Boxes
Total Vol. 0,256 m³.
Gross weight 10 Kg.
Net weight 6 Kg.

6135 10 /1A White
(NCS S 0300-N)

6135 15 /1A Grey L2
(NCS S 2500-N)

6135 16 /1A Grey M1
(NCS S 4500-N)

6135 21 /1A Grey D1
(NCS S 7000-N)



6140

New

Light Source



3 x LED PLATE 10,5W 700mA.
LED 2700 K. CRI >90. 4350 lm. 138 lm/W.
Driver Constant Current 700 mA.
110-240V. 50/60Hz.
Dimming: DALI, 1-10V, Push.

Personalization options available

- Configuration layout at vibia.com
- LED 3000 K / 4000 K.
Min. quantity, upcharge and extra lead time apply.

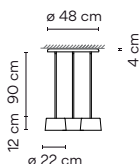

Materials

Led support: Aluminum.
Tube: Steel.
Canopy: Steel.

Packaging

2 Boxes
Total Vol. 0,292 m³.
Gross weight 11 Kg.
Net weight 7,5 Kg.

6140 10 /1A White
(NCS S 0300-N)

6140 71 /1A Grey L2, Grey M1, Grey D1
(NCS S 2500-N, NCS S 4500-N, NCS S 7000-N)

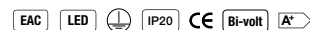

Tube

6145 New **Light Source**

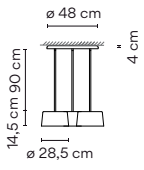

3 x LED PLATE 13,5W 700mA.
LED 2700 K. CRI >90. 5220 lm. 128,9 lm/W.
Driver Constant Current 700 mA.
 220-240V. 50/60Hz.
Dimming: DALI, 1-10V, Push.

Personalization options available
 - Configuration layout at vibia.com
 - LED 3000 K / 4000 K.
 Min. quantity, upcharge and extra lead time apply.

Materials
 Led support: Aluminum.
 Tube: Steel.
 Canopy: Steel.

Packaging
 2 Boxes
 Total Vol. 0,292 m³.
 Gross weight 12 Kg.
 Net weight 8,5 Kg.

6145 10 /1A White
 (NCS S 0300-N)

6145 71 /1A Grey L2, Grey M1, Grey D1
 (NCS S 2500-N, NCS S 4500-N, NCS S 7000-N)

EAC LED IP20 CE A*

6150 New **Light Source**

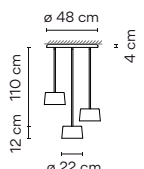

3 x LED PLATE 10,5W 700mA.
LED 2700 K. CRI >90. 4350 lm. 138 lm/W.
Driver Constant Current 700 mA.
 110-240V. 50/60Hz.
Dimming: DALI, 1-10V, Push.

Personalization options available
 - Configuration layout at vibia.com
 - LED 3000 K / 4000 K.
 Min. quantity, upcharge and extra lead time apply.

Materials
 Led support: Aluminum.
 Tube: Steel.
 Canopy: Steel.

Packaging
 2 Boxes
 Total Vol. 0,292 m³.
 Gross weight 13 Kg.
 Net weight 9,5 Kg.

6150 10 /1A White
 (NCS S 0300-N)

6150 71 /1A Grey L2, Grey M1, Grey D1
 (NCS S 2500-N, NCS S 4500-N, NCS S 7000-N)

EAC LED IP20 CE Bi-volt A*

6155 New **Light Source**

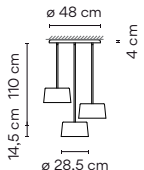

3 x LED PLATE 13,5W 700mA.
LED 2700 K. CRI >90. 5220 lm. 128,9 lm/W.
Driver Constant Current 700 mA.
 220-240V. 50/60Hz.
Dimming: DALI, 1-10V, Push.

Personalization options available
 - Configuration layout at vibia.com
 - LED 3000 K / 4000 K.
 Min. quantity, upcharge and extra lead time apply.

Materials
 Led support: Aluminum.
 Tube: Steel.
 Canopy: Steel.

Packaging
 2 Boxes
 Total Vol. 0,292 m³.
 Gross weight 12 Kg.
 Net weight 8,5 Kg.

6155 10 /1A White
 (NCS S 0300-N)

6155 71 /1A Grey L2, Grey M1, Grey D1
 (NCS S 2500-N, NCS S 4500-N, NCS S 7000-N)

EAC LED IP20 CE A*

Curtain

Design by Arik Levy

Inspired by sunlight streaming through a curtain, this pendant features reflective fabric screens suspended from ceiling cables. The light compliments the reflective qualities of the fabrics emitting a cascading waterfall of light.

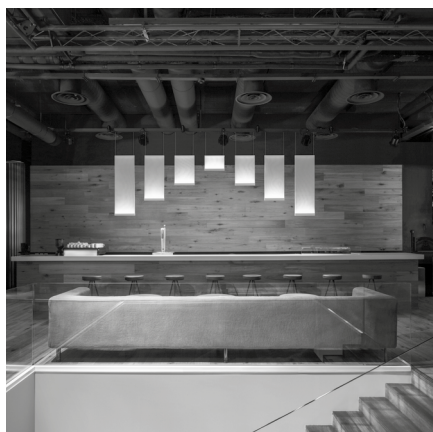

1 - Select typology and size.

2 - Select screen and profile finished.

Single version

White Screen

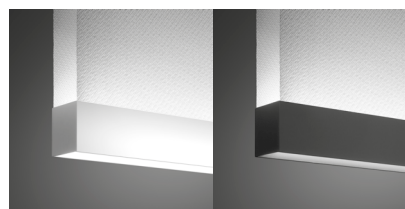
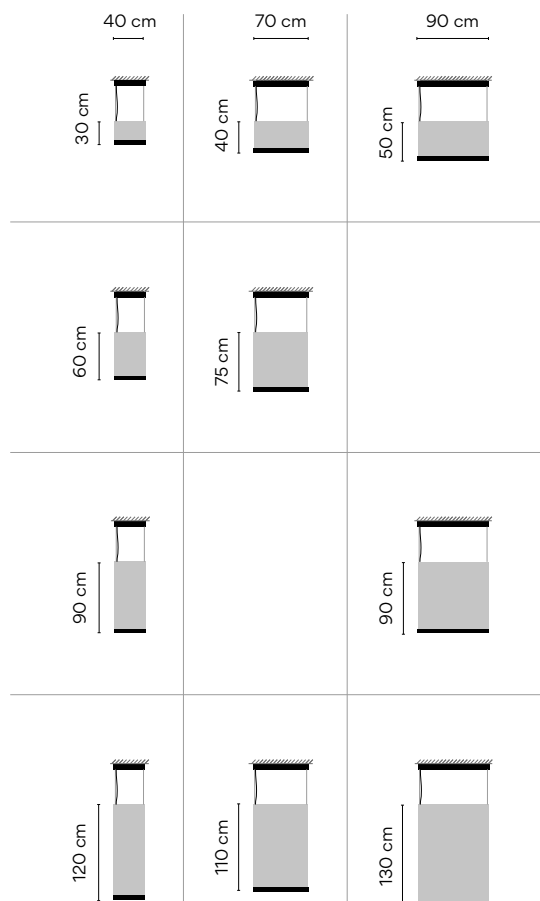

White profile.

Graphite profile.

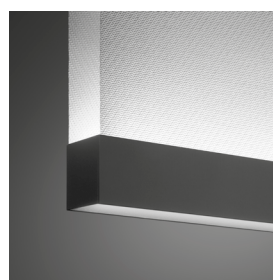

Uplighting & Downlighting.

Curtain

Pendants

7140

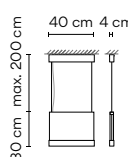

Light Source
 2 x LED STRIP 8,4W 700mA.
 LED 2700 K. CRI >80. 2635,5 lm. 156,8 lm/W.
 Driver Constant Current 700 mA.
 110-240V. 50/60Hz.
 Dimming: 1-10V, Push.

Personalization options available
 - LED 3000 K / 4000 K.
 - Dimming: DALI.
 - Extra cable length.
 Min. quantity, upcharge and extra lead time apply.

Materials
 Profile: Aluminum.
 Diffuser: Polycarbonate.
 Curtain: Screen.

Packaging
 1 Box
 0,175 x 0,39 x 0,51 m.
 Vol. 0,0348 m³.
 Gross weight 3,10 Kg.
 Net weight 2,05 Kg.

7140 18 /1B White screen and graphite profile (ADAPTA RF 9913 WX)
7140 93 /1B White screen and white profile (RAL 9016)

EAC LED IP20 CE Bi-volt A++

7150

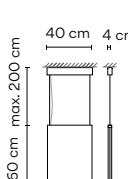

Light Source
 2 x LED STRIP 8,4W 700mA.
 LED 2700 K. CRI >80. 2635,5 lm. 156,8 lm/W.
 Driver Constant Current 700 mA.
 110-240V. 50/60Hz.
 Dimming: 1-10V, Push.

Personalization options available
 - LED 3000 K / 4000 K.
 - Dimming: DALI.
 - Extra cable length.
 Min. quantity, upcharge and extra lead time apply.

Materials
 Profile: Aluminum.
 Diffuser: Polycarbonate.
 Curtain: Screen.

Packaging
 1 Box
 0,175 x 0,39 x 0,51 m.
 Vol. 0,0348 m³.
 Gross weight 3,20 Kg.
 Net weight 2,15 Kg.

7150 18 /1B White screen and graphite profile (ADAPTA RF 9913 WX)
7150 93 /1B White screen and white profile (RAL 9016)

EAC LED IP20 CE Bi-volt A++

7160

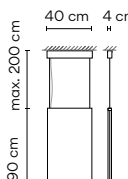

Light Source
 2 x LED STRIP 8,4W 700mA.
 LED 2700 K. CRI >80. 2635,5 lm. 156,8 lm/W.
 Driver Constant Current 700 mA.
 110-240V. 50/60Hz.
 Dimming: 1-10V, Push.

Personalization options available
 - LED 3000 K / 4000 K.
 - Dimming: DALI.
 - Extra cable length.
 Min. quantity, upcharge and extra lead time apply.

Materials
 Profile: Aluminum.
 Diffuser: Polycarbonate.
 Curtain: Screen.

Packaging
 1 Box
 0,175 x 0,39 x 0,51 m.
 Vol. 0,0348 m³.
 Gross weight 3,35 Kg.
 Net weight 2,30 Kg.

7160 18 /1B White screen and graphite profile (ADAPTA RF 9913 WX)
7160 93 /1B White screen and white profile (RAL 9016)

EAC LED IP20 CE Bi-volt A++

7170

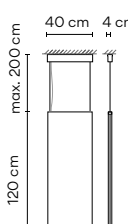

Light Source
 2 x LED STRIP 8,4W 700mA.
 LED 2700 K. CRI >80. 2635,5 lm. 156,8 lm/W.
 Driver Constant Current 700 mA.
 110-240V. 50/60Hz.
 Dimming: 1-10V, Push.

Personalization options available
 - LED 3000 K / 4000 K.
 - Dimming: DALI.
 - Extra cable length.
 Min. quantity, upcharge and extra lead time apply.

Materials
 Profile: Aluminum.
 Diffuser: Polycarbonate.
 Curtain: Screen.

Packaging
 1 Box
 0,175 x 0,39 x 0,51 m.
 Vol. 0,0348 m³.
 Gross weight 3,45 Kg.
 Net weight 2,40 Kg.

7170 18 /1B White screen and graphite profile (ADAPTA RF 9913 WX)
7170 93 /1B White screen and white profile (RAL 9016)

EAC LED IP20 CE Bi-volt A++

Curtain

7180

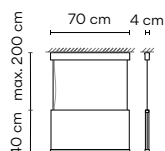

Light Source

2 x LED STRIP 6,3W 700mA.
2 x LED STRIP 8,4W 700mA.
LED 2700 K. CRI >80. 4612,2 lm. 156,8 lm/W.
Driver Constant Current 700 mA.
110-240V. 50/60Hz.
Dimming: 1-10V, Push.

Personalization options available

- LED 3000 K / 4000 K.
- Dimming: DALI.
- Extra cable length.
Min. quantity, upcharge and extra lead time apply.

Materials

Profile: Aluminum.
Diffuser: Polycarbonate.
Curtain: Screen.

Packaging

1 Box
0,175 x 0,39 x 0,81 m.
Vol. 0,0554 m³.
Gross weight 4,95 Kg.
Net weight 3,50 Kg.

7180 18 /1B White screen and graphite profile (ADAPTA RF 9913 WX)

7180 93 /1B White screen and white profile (RAL 9016)

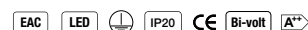

7190

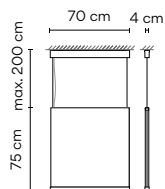

Light Source

2 x LED STRIP 6,3W 700mA.
2 x LED STRIP 8,4W 700mA.
LED 2700 K. CRI >80. 4612,2 lm. 156,8 lm/W.
Driver Constant Current 700 mA.
110-240V. 50/60Hz.
Dimming: 1-10V, Push.

Personalization options available

- LED 3000 K / 4000 K.
- Dimming: DALI.
- Extra cable length.
Min. quantity, upcharge and extra lead time apply.

Materials

Profile: Aluminum.
Diffuser: Polycarbonate.
Curtain: Screen.

Packaging

1 Box
0,175 x 0,39 x 0,81 m.
Vol. 0,0554 m³.
Gross weight 5,25 Kg.
Net weight 3,80 Kg.

7190 18 /1B White screen and graphite profile (ADAPTA RF 9913 WX)

7190 93 /1B White screen and white profile (RAL 9016)

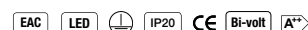

7200

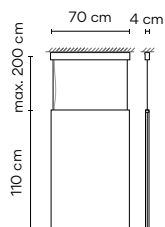

Light Source

2 x LED STRIP 6,3W 700mA.
2 x LED STRIP 8,4W 700mA.
LED 2700 K. CRI >80. 4612,2 lm. 156,8 lm/W.
Driver Constant Current 700 mA.
110-240V. 50/60Hz.
Dimming: 1-10V, Push.

Personalization options available

- LED 3000 K / 4000 K.
- Dimming: DALI.
- Extra cable length.
Min. quantity, upcharge and extra lead time apply.

Materials

Profile: Aluminum.
Diffuser: Polycarbonate.
Curtain: Screen.

Packaging

1 Box
0,175 x 0,39 x 0,81 m.
Vol. 0,0554 m³.
Gross weight 5,50 Kg.
Net weight 4,05 Kg.

7200 18 /1B White screen and graphite profile (ADAPTA RF 9913 WX)

7200 93 /1B White screen and white profile (RAL 9016)



7210

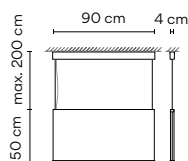

Light Source

6 x LED STRIP 6,3W 700mA.
LED 2700 K. CRI >80. 5929,9 lm. 156,8 lm/W.
Driver Constant Current 700 mA.
220-240V. 50/60Hz.
Dimming: 1-10V, Push.

Personalization options available

- LED 3000 K / 4000 K.
- Dimming: DALI.
- Extra cable length.
Min. quantity, upcharge and extra lead time apply.

Materials

Profile: Aluminum.
Diffuser: Polycarbonate.
Curtain: Screen.

Packaging

1 Box
0,175 x 0,391 x 1,011 m.
Vol. 0,0691 m³.
Gross weight 6,05 Kg.
Net weight 4,40 Kg.

7210 18 /1B White screen and graphite profile (ADAPTA RF 9913 WX)

7210 93 /1B White screen and white profile (RAL 9016)



Curtain

7220

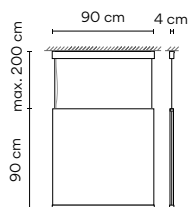

Light Source

6 x LED STRIP 6,3W 700mA.
LED 2700 K. CRI >80. 5929,9 lm. 156,8 lm/W.
Driver Constant Current 700 mA.
220-240V. 50/60Hz.
Dimming: 1-10V, Push.

Personalization options available

- LED 3000 K / 4000 K.
- Dimming: DALI.
- Extra cable length.

Min. quantity, upcharge and extra lead time apply.

Materials

Profile: Aluminum.
Diffuser: Polycarbonate.
Curtain: Screen.

Packaging

1 Box
0,175 x 0,391 x 1,011 m.
Vol. 0,0691 m³.
Gross weight 6,45 Kg.
Net weight 4,80 Kg.

7220 18 /1B White screen and graphite profile (ADAPTA RF 9913 WX)

7220 93 /1B White screen and white profile (RAL 9016)



7230

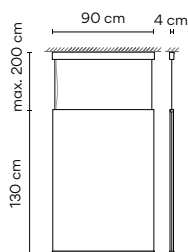

Light Source

6 x LED STRIP 6,3W 700mA.
LED 2700 K. CRI >80.
5929,9 lm. 156,8 lm/W.
Driver Constant Current 700 mA.
220-240V. 50/60Hz.
Dimming: 1-10V, Push.

Personalization options available

- LED 3000 K / 4000 K.
- Dimming: DALI.
- Extra cable length.

Min. quantity, upcharge and extra lead time apply.

Materials

Profile: Aluminum.
Diffuser: Polycarbonate.
Curtain: Screen.

Packaging

1 Box
0,175 x 0,391 x 1,011 m.
Vol. 0,0691 m³.
Gross weight 6,35 Kg.
Net weight 5,20 Kg.

7230 18 /1B White screen and graphite profile (ADAPTA RF 9913 WX)

7230 93 /1B White screen and white profile (RAL 9016)



Musa

Design by Note Design Studio

Delicate elegance.

It explores the delicacy of nature which is both strong and powerful, in a poetic expression of light.



Table

7400

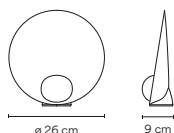

Light Source



1 x LED 4,5W 350mA.
LED 2700 K. CRI >90. 449 lm. 99,7 lm/W.
Driver Constant Voltage 24V.
100-240V. 50/60Hz.
Dimming: Push.

Dimmer switch on the base.
Electric cable with plug. 3 m.

Personalization options available

- Finish customization.
(Available options: Vibia color palette).
- LED 3000 K / 4000 K.
Min. quantity, upcharge and extra lead time apply.

Materials

Diffuser: Blown glass.
Body: Aluminum.

Packaging

1 Box
0,17 x 0,32 x 0,3 m.
Vol. 0,0163 m³.
Gross weight 1,3 Kg.
Net weight 0,85 Kg.

7400 58 /15 Salmon
(NCS S 1010-Y50R)

7400 59 /15 Mink
(NCS S2005-Y50R)

7400 93 /15 White
(RAL 9016)



7402

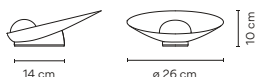

Light Source



1 x LED 4,5W 350mA.
LED 2700 K. CRI >90. 449 lm. 99,7 lm/W.
Driver Constant Voltage 24V.
100-240V. 50/60Hz.
Dimming: Push.

Dimmer switch on the base.
Electric cable with plug. 3 m.

Personalization options available

- Finish customization.
(Available options: Vibia color palette).
- LED 3000 K / 4000 K.
Min. quantity, upcharge and extra lead time apply.

Materials

Diffuser: Blown glass.
Body: Aluminum.

Packaging

1 Box
0,17 x 0,32 x 0,3 m.
Vol. 0,0163 m³.
Gross weight 1,3 Kg.
Net weight 0,85 Kg.

7402 58 /15 Salmon
(NCS S 1010-Y50R)

7402 59 /15 Mink
(NCS S2005-Y50R)

7402 93 /15 White
(RAL 9016)



7404

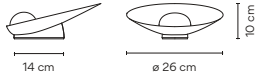

Light Source



1 x LED 2,1W 700mA.
LED 2700 K. CRI >90. 238 lm. 113 lm/W.
Driver Constant Voltage 5V.
 100-240V. 50/60Hz.
Dimming: Push.

Portable version with battery.
 Dimmer switch on the base. 3 step dimming.
 Electric cable with plug. 3 m.
 Battery life: from 6 to 18 hours
 (depending on intensity).

Personalization options available

- Finish customization.
 (Available options: Vibia color palette).
 - LED 3000 K / 4000 K.
- Min. quantity, upcharge and extra lead time apply.

Materials

Diffuser: Blown glass.
 Body: Aluminum.

Packaging

1 Box
 0,17 x 0,32 x 0,3 m.
 Vol. 0,0163 m³.
 Gross weight 1,4 Kg.
 Net weight 0,95 Kg.

7404 58 /15 Salmon
 (NCS S 1010-Y50R)

7404 59 /15 Mink
 (NCS S2005-Y50R)

7404 93 /15 White
 (RAL 9016)



Wall

7415

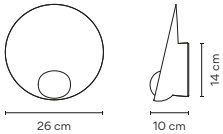

Light Source



1 x LED 4,5W 350mA.
LED 2700 K. CRI >90. 449 lm. 99,7 lm/W.
Driver Constant Current 350 mA.
 220-240V. 50/60Hz.
Dimming: 1-10V.

Personalization options available

- Finish customization.
 (Available options: Vibia color palette).
 - LED 3000 K / 4000 K.
- Min. quantity, upcharge and extra lead time apply.

Materials

Diffuser: Blown glass.
 Body: Aluminum.

Packaging

1 Box
 0,17 x 0,32 x 0,3 m.
 Vol. 0,0163 m³.
 Gross weight 1,8 Kg.
 Net weight 1,3 Kg.

7415 58 /13 Salmon
 (NCS S 1010-Y50R)

7415 59 /13 Mink
 (NCS S2005-Y50R)

7415 93 /13 White
 (RAL 9016)



Set

Design by Xuclà

A game of light, shadows and volumes, Set is a new concept of modular wall sconces that composes light as art onto the walls. During the day Set decorates the wall with a pattern of rectangular elements, but once illuminated it creates a surprising feature of lights, shadows and volumes.

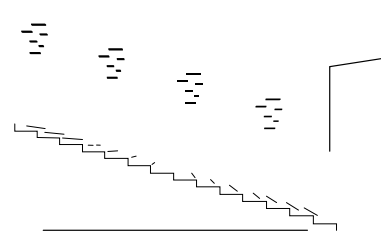
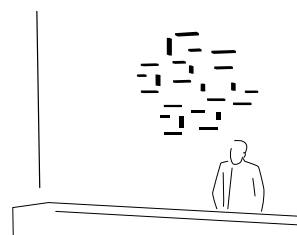
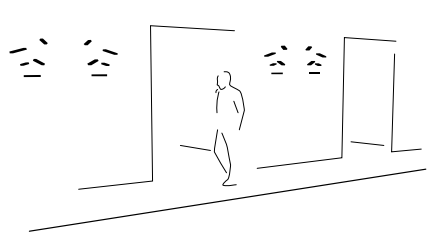

Create your product configuration quickly and easily at vibia.com

Go to vibia.com and discover the quickest, most effective way to configure a unique Set design.

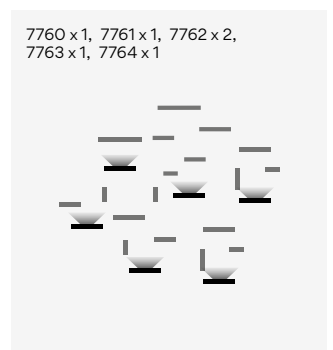
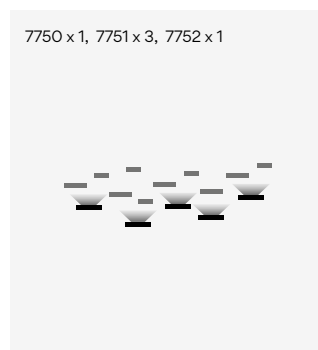
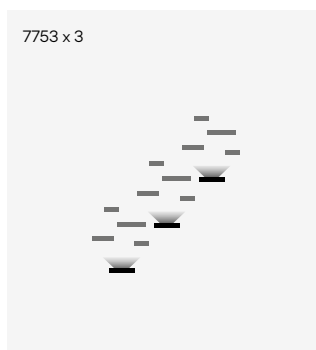
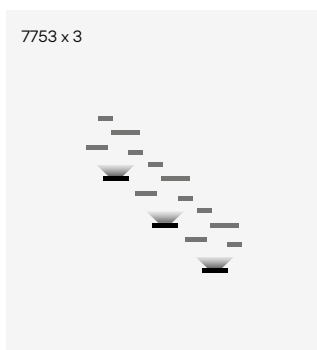

Wall

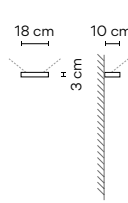
<p>7749</p> 	<p>Light Source</p> <p>Ⓢ</p> <p>1 x LED 9W 350mA. LED 2700 K. CRI >80. 1041 lm. 116 lm/W. Driver Constant Current 350 mA. 100-240V. 50/60Hz. Dimming: 0-10V.</p> <p>LED placed on the lower element. Small.</p> <p>Personalization options available</p> <ul style="list-style-type: none"> - Configuration layout at vibia.com - LED 3000 K / 4000 K. <p>Min. quantity, upcharge and extra lead time apply.</p>	<p>Materials</p> <p>Body: Aluminum. Diffuser: Borosilicate glass. Lid: Polycarbonate.</p> <p>Packaging</p> <p>1 Box 0,065 x 0,145 x 0,275 m. Vol. 0,0026 m³. Gross weight 0,67 Kg. Net weight 0,52 Kg.</p>	<p>7749 59 /12 Mink (PANTONE 407)</p> <hr/> <p>7749 93 /12 White (RAL 9003)</p> <hr/> <p>EAC LED IP20 CE Bi-volt A*</p>
--	--	---	---

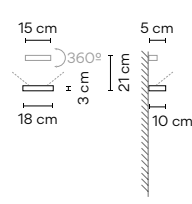
<p>7750</p> 	<p>Light Source</p> <p>Ⓢ</p> <p>1 x LED 9W 350mA. LED 2700 K. CRI >80. 1041 lm. 116 lm/W. Driver Constant Current 350 mA. 100-240V. 50/60Hz. Dimming: 0-10V.</p> <p>LED placed on the lower element. Small.</p> <p>Personalization options available</p> <ul style="list-style-type: none"> - Configuration layout at vibia.com - LED 3000 K / 4000 K. <p>Min. quantity, upcharge and extra lead time apply.</p>	<p>Materials</p> <p>Body: Aluminum. Diffuser: Borosilicate glass. Reflector body: Foamed PVC. Lid: Polycarbonate.</p> <p>Packaging</p> <p>1 Box 0,15 x 0,132 x 0,36 m. Vol. 0,0071 m³. Gross weight 0,95 Kg. Net weight 0,8 Kg.</p>	<p>7750 59 /12 Mink (PANTONE 407)</p> <hr/> <p>7750 93 /12 White (RAL 9003)</p> <hr/> <p>EAC LED IP20 CE Bi-volt A*</p>
---	--	--	---

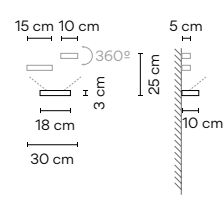
<p>7751</p> 	<p>Light Source</p> <p>Ⓢ</p> <p>1 x LED 9W 350mA. LED 2700 K. CRI >80. 1041 lm. 116 lm/W. Driver Constant Current 350 mA. 100-240V. 50/60Hz. Dimming: 0-10V.</p> <p>LED placed on the lower element. Small.</p> <p>Personalization options available</p> <ul style="list-style-type: none"> - Configuration layout at vibia.com - LED 3000 K / 4000 K. <p>Min. quantity, upcharge and extra lead time apply.</p>	<p>Materials</p> <p>Body: Aluminum. Diffuser: Borosilicate glass. Reflector body: Foamed PVC. Lid: Polycarbonate.</p> <p>Packaging</p> <p>1 Box 0,15 x 0,132 x 0,36 m. Vol. 0,0071 m³. Gross weight 1,25 Kg. Net weight 1,1 Kg.</p>	<p>7751 59 /12 Mink (PANTONE 407)</p> <hr/> <p>7751 93 /12 White (RAL 9003)</p> <hr/> <p>EAC LED IP20 CE Bi-volt A*</p>
--	--	--	---

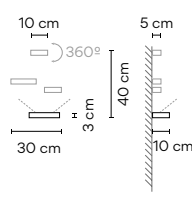
<p>7752</p> 	<p>Light Source</p> <p>Ⓢ</p> <p>1 x LED 9W 350mA. LED 2700 K. CRI >80. 1041 lm. 116 lm/W. Driver Constant Current 350 mA. 100-240V. 50/60Hz. Dimming: 0-10V.</p> <p>LED placed on the lower element. Small.</p> <p>Personalization options available</p> <ul style="list-style-type: none"> - Configuration layout at vibia.com - LED 3000 K / 4000 K. <p>Min. quantity, upcharge and extra lead time apply.</p>	<p>Materials</p> <p>Body: Aluminum. Diffuser: Borosilicate glass. Reflector body: Foamed PVC. Lid: Polycarbonate.</p> <p>Packaging</p> <p>1 Box 0,15 x 0,132 x 0,36 m. Vol. 0,0071 m³. Gross weight 1,6 Kg. Net weight 1,4 Kg.</p>	<p>7752 59 /12 Mink (PANTONE 407)</p> <hr/> <p>7752 93 /12 White (RAL 9003)</p> <hr/> <p>EAC LED IP20 CE Bi-volt A*</p>
--	--	---	---

7753

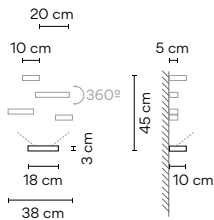

Light Source



1 x LED 9W 350mA.
LED 2700 K. CRI >80. 1041 lm. 116 lm/W.
Driver Constant Current 350 mA.
 100-240V. 50/60Hz.
Dimming: 0-10V.

LED placed on the lower element.
 Small.

Personalization options available

- Configuration layout at vibia.com
 - LED 3000 K / 4000 K.
 Min. quantity, upcharge and extra lead time apply.

Materials

Body: Aluminum.
 Diffuser: Borosilicate glass.
 Reflector body:
 Foamed PVC.
 Lid: Polycarbonate.

Packaging

1 Box
 0,15 x 0,193 x 0,36 m.
 Vol. 0,0100 m³.
 Gross weight 2 Kg.
 Net weight 1,5 Kg.

7753 59 /12 Mink
 (PANTONE 407)

7753 93 /12 White
 (RAL 9003)



7759

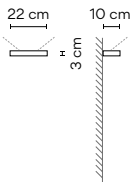

Light Source



1 x LED 9W 350mA.
LED 2700 K. CRI >80. 1041 lm. 116 lm/W.
Driver Constant Current 350 mA.
 100-240V. 50/60Hz.
Dimming: 0-10V.

LED placed on the lower element.
 Big.

Personalization options available

- Configuration layout at vibia.com
 - LED 3000 K / 4000 K.
 Min. quantity, upcharge and extra lead time apply.

Materials

Body: Aluminum.
 Diffuser: Borosilicate glass.
 Lid: Polycarbonate.

Packaging

1 Box
 0,065 x 0,145 x 0,275 m.
 Vol. 0,0026 m³.
 Gross weight 0,75 Kg.
 Net weight 0,6 Kg.

7759 59 /12 Mink
 (PANTONE 407)

7759 93 /12 White
 (RAL 9003)

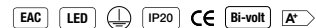

7760

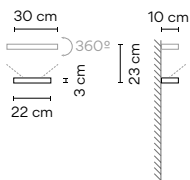

Light Source



1 x LED 9W 350mA.
LED 2700 K. CRI >80. 1041 lm. 116 lm/W.
Driver Constant Current 350 mA.
 100-240V. 50/60Hz.
Dimming: 0-10V.

LED placed on the lower element.
 Big.

Personalization options available

- Configuration layout at vibia.com
 - LED 3000 K / 4000 K.
 Min. quantity, upcharge and extra lead time apply.

Materials

Body: Aluminum.
 Diffuser: Borosilicate glass.
 Reflector body:
 Foamed PVC.
 Lid: Polycarbonate.

Packaging

1 Box
 0,15 x 0,132 x 0,36 m.
 Vol. 0,0071 m³.
 Gross weight 1,4 Kg.
 Net weight 1,1 Kg.

7760 59 /12 Mink
 (PANTONE 407)

7760 93 /12 White
 (RAL 9003)

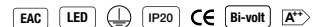

7761

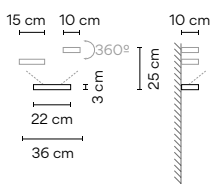

Light Source



1 x LED 9W 350mA.
LED 2700 K. CRI >80. 1041 lm. 116 lm/W.
Driver Constant Current 350 mA.
 100-240V. 50/60Hz.
Dimming: 0-10V.

LED placed on the lower element.
 Big.

Personalization options available

- Configuration layout at vibia.com
 - LED 3000 K / 4000 K.
 Min. quantity, upcharge and extra lead time apply.

Materials

Body: Polyurethane foam.
 Diffuser: Polycarbonate.
 Reflector body:
 Foamed PVC.
 Lid: Polycarbonate.

Packaging

1 Box
 0,15 x 0,132 x 0,36 m.
 Vol. 0,0071 m³.
 Gross weight 1,5 Kg.
 Net weight 1,2 Kg.

7761 59 /12 Mink
 (PANTONE 407)

7761 93 /12 White
 (RAL 9003)

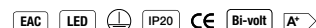

7762

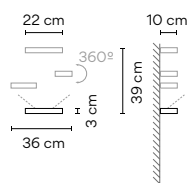
**Light Source**

1 x LED 9W 350mA.
LED 2700 K. CRI >80. 1041 lm. 116 lm/W.
Driver Constant Current 350 mA.
 100-240V. 50/60Hz.
Dimming: 0-10V.

LED placed on the lower element.
 Big.

Personalization options available

- Configuration layout at vibia.com
 - LED 3000 K / 4000 K.

Min. quantity, upcharge and extra lead time apply.

Materials

Body: Aluminum.
 Diffuser: Borosilicate glass.
 Reflector body:
 Foamed PVC.
 Lid: Polycarbonate.

Packaging

1 Box
 0,15 x 0,193 x 0,36 m.
 Vol. 0,0100 m³.
 Gross weight 1,9 Kg.
 Net weight 1,4 Kg.

7762 59 /12 Mink
 (PANTONE 407)

7762 93 /12 White
 (RAL 9003)

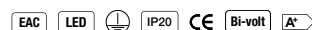

7763

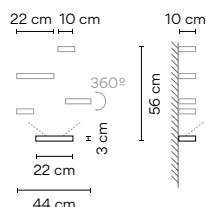
**Light Source**

1 x LED 9W 350mA.
LED 2700 K. CRI >80. 1041 lm. 116 lm/W.
Driver Constant Current 350 mA.
 100-240V. 50/60Hz.
Dimming: 0-10V.

LED placed on the lower element.
 Big.

Personalization options available

- Configuration layout at vibia.com
 - LED 3000 K / 4000 K.

Min. quantity, upcharge and extra lead time apply.

Materials

Body: Aluminum.
 Diffuser: Borosilicate glass.
 Reflector body:
 Foamed PVC.
 Lid: Polycarbonate.

Packaging

1 Box
 0,15 x 0,193 x 0,36 m.
 Vol. 0,0100 m³.
 Gross weight 2,25 Kg.
 Net weight 1,75 Kg.

7763 59 /12 Mink
 (PANTONE 407)

7763 93 /12 White
 (RAL 9003)

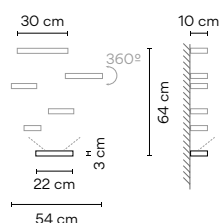

7764

**Light Source**

1 x LED 9W 350mA.
LED 2700 K. CRI >80. 1041 lm. 116 lm/W.
Driver Constant Current 350 mA.
 100-240V. 50/60Hz.
Dimming: 0-10V.

LED placed on the lower element.
 Big.

Personalization options available

- Configuration layout at vibia.com
 - LED 3000 K / 4000 K.

Min. quantity, upcharge and extra lead time apply.

Materials

Body: Aluminum.
 Diffuser: Borosilicate glass.
 Reflector body:
 Foamed PVC.
 Lid: Polycarbonate.

Packaging

1 Box
 0,15 x 0,193 x 0,36 m.
 Vol. 0,0100 m³.
 Gross weight 2,75 Kg.
 Net weight 2,25 Kg.

7764 59 /12 Mink
 (PANTONE 407)

7764 93 /12 White
 (RAL 9003)

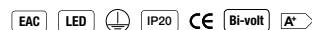

Alpha

Design by Ramos & Bassols

An embedded light breaking free to serve.



Wall

7920

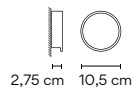

Light Source

1 x LED 2,1W 700mA.
LED 2700 K. CRI >80. 199 lm. 95 lm/W.
Driver Constant Current 700 mA.
100-240V. 50/60Hz.

Surface.

Personalization options available
- LED 3000 K / 4000 K.
Min. quantity, upcharge and extra lead time apply.

Materials

Box: Zamak.
Diffuser: Polycarbonate.
Lid: Steel.

Packaging

1 Box
0,13 x 0,20 x 0,21 m.
Vol. 0,0055 m³.
Gross weight 1 Kg.
Net weight 0,444 Kg.

7920 03 /10 White and chrome
(RAL 9016)

7920 04 /10 Black and chrome
(RAL 9005)

7920 18 /10 Graphite and black
(RAL 7016)

7920 93 /10 White
(RAL 9016)

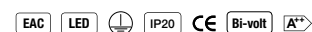

7925

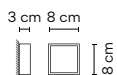

Light Source

1 x LED 2,1W 700mA.
LED 2700 K. CRI >80. 199 lm. 95 lm/W.
Driver Constant Current 700 mA.
100-240V. 50/60Hz.

Surface.

Personalization options available
- LED 3000 K / 4000 K.
Min. quantity, upcharge and extra lead time apply.

Materials

Box: Zamak.
Diffuser: Polycarbonate.
Lid: Steel.

Packaging

1 Box
0,13 x 0,21 x 0,20 m.
Vol. 0,0055 m³.
Gross weight 1 Kg.
Net weight 0,32 Kg.

7925 03 /10 White and chrome
(RAL 9016)

7925 04 /10 Black and chrome
(RAL 9005)

7925 18 /10 Graphite and black
(RAL 7016)

7925 93 /10 White
(RAL 9016)

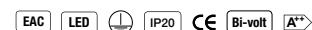

7930

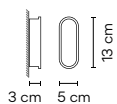

Light Source

2 x LED 2,1W 700mA.
LED 2700 K. CRI >80. 399 lm. 95 lm/W.
Driver Constant Current 700 mA.
100-240V. 50/60Hz.

Surface.

Personalization options available
- LED 3000 K / 4000 K.
Min. quantity, upcharge and extra lead time apply.

Materials

Box: Zamak.
Diffuser: Polycarbonate.
Lid: Steel.

Packaging

1 Box
0,13 x 0,20 x 0,21 m.
Vol. 0,0055 m³.
Gross weight 0,9 Kg.
Net weight 0,3 Kg.

7930 03 /10 White and chrome
(RAL 9016)

7930 04 /10 Black and chrome
(RAL 9005)

7930 18 /10 Graphite and black
(RAL 7016)

7930 93 /10 White
(RAL 9016)

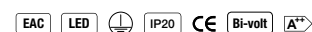

7935

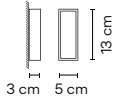

Light Source



2 x LED 2,1W 700mA.
LED 2700 K. CRI >80. 399 lm. 95 lm/W.
Driver Constant Current 700 mA.
 100-240V. 50/60Hz.

Surface.

Personalization options available

- LED 3000 K / 4000 K.
 Min. quantity, upcharge and extra lead time apply.

Materials

Box: Zamak.
 Diffuser: Polycarbonate.
 Lid: Steel.

Packaging

1 Box
 0,13 x 0,20 x 0,21 m.
 Vol. 0,0055 m³.
 Gross weight 0,9 Kg.
 Net weight 0,3 Kg.

7935 03 /10 White and chrome
 (RAL 9016)

7935 04 /10 Black and chrome
 (RAL 9005)

7935 18 /10 Graphite and black
 (RAL 7016)

7935 93 /10 White
 (RAL 9016)



7940

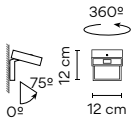

Light Source



1 x LED 2,1W 700mA.
LED 2700 K. CRI >80. 199 lm. 95 lm/W.
Driver Constant Current 700 mA.
 100-240V. 50/60Hz.

Surface.

On/off switch on the front cover.

Personalization options available

- LED 3000 K / 4000 K.
 Min. quantity, upcharge and extra lead time apply.

Materials

Diffuser: Polycarbonate.
 Lid: Zamak.
 Body: Aluminum.
 Lid: Aluminum.

Packaging

1 Box
 0,13 x 0,20 x 0,20 m.
 Vol. 0,0055 m³.
 Gross weight 1,2 Kg.
 Net weight 1 Kg.

7940 03 /10 White and chrome
 (RAL 9016)

7940 04 /10 Black and chrome
 (RAL 9005)

7940 18 /10 Graphite and black
 (RAL 7016)

7940 93 /10 White
 (RAL 9016)



7942

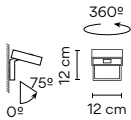

Light Source



1 x LED 2,1W 700mA.
LED 2700 K. CRI >80. 199 lm. 95 lm/W.
Driver Constant Current 700 mA.
 100-240V. 50/60Hz.

Surface.

Without switch.

Personalization options available

- LED 3000 K / 4000 K.
 Min. quantity, upcharge and extra lead time apply.

Materials

Diffuser: Polycarbonate.
 Lid: Zamak.
 Body: Aluminum.
 Lid: Aluminum.

Packaging

1 Box
 0,13 x 0,20 x 0,20 m.
 Vol. 0,0055 m³.
 Gross weight 1,2 Kg.
 Net weight 1 Kg.

7942 03 /10 White and chrome
 (RAL 9016)

7942 04 /10 Black and chrome
 (RAL 9005)

7942 18 /10 Graphite and black
 (RAL 7016)

7942 93 /10 White
 (RAL 9016)



7950

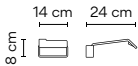

Light Source



3 x LED 2,1W 700mA.
LED 2700 K. CRI >80. 598 lm. 95 lm/W.
Driver Constant Current 700 mA.
 100-240V. 50/60Hz.

Surface.

Light beam with no IR and UV.

Personalization options available

- LED 3000 K / 4000 K.
 Min. quantity, upcharge and extra lead time apply.

Materials

Diffuser: Polycarbonate.
 Lid: Zamak.
 Body: Aluminum.
 Lid: Aluminum.

Packaging

1 Box
 0,26 x 0,26 x 0,26 m.
 Vol. 0,0175 m³.
 Gross weight 1,56 Kg.
 Net weight 0,65 Kg.

7950 03 /10 White and chrome
 (RAL 9016)

7950 04 /10 Black and chrome
 (RAL 9005)

7950 18 /10 Graphite and black
 (RAL 7016)

7950 93 /10 White
 (RAL 9016)



7955

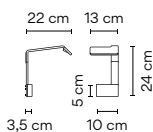

Light Source



3 x LED 2,1W 700mA.
LED 2700 K. CRI >80. 598 lm. 95 lm/W.
Driver Constant Current 700 mA.
 100-240V. 50/60Hz.

Surface.

Light beam with no IR and UV.

Personalization options available

- LED 3000 K / 4000 K.
 Min. quantity, upcharge and extra lead time apply.

Materials

Diffuser: Polycarbonate.
 Lid: Zamak.
 Body: Aluminum.
 Lid: Aluminum.

Packaging

1 Box
 0,23 x 0,37 x 0,37 m.
 Vol. 0,0310 m³.
 Gross weight 0,97 Kg.
 Net weight 0,47 Kg.

7955 03 /10 White
 (RAL 9016)

7955 04 /10 Black
 (RAL 9005)

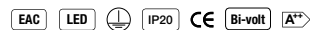

Linestra

Sleek and minimalist wall light, the diffuser directs the light to wash the walls creating a bright ambient lighting.



Wall

8030

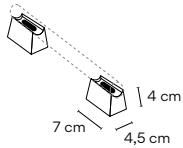

Light Source



1 x S14s 230V 6W LED
Or
1 x S14s 230V 9W LED

Surface.
Only available in 12-unit box.

Materials

Body: Aluminum.

Packaging

1 Box
0,10 x 0,12 x 0,365 m.
Vol. 0,0043 m³.
Gross weight 1,85 Kg.
Net weight 1,7 Kg.

8030 01 Chrome
(Metallic finish)

8030 30 Nickel
(Metallic finish)



8031

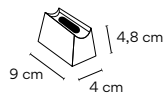

Light Source



1 x S14d 230V 6W LED
Or
1 x S14s 230V 9W LED

Only available in 6-unit box.

Materials

Body: Aluminum.

Packaging

1 Box
0,10 x 0,12 x 0,365 m.
Vol. 0,0043 m³.
Gross weight 1,4 Kg.
Net weight 1,25 Kg.

8031 01 Chrome
(Metallic finish)

8031 30 Nickel
(Metallic finish)



Millenium

Design by Ramos & Bassols

A slim cylinder of illumination, Millenium distills task lighting to its essence. Sleek and minimalist, the diffuser directs the light downwards to wash a wall or bathroom mirror.



Wall

8090

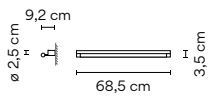

Light Source

1 x G5 230V 24W (T5).
Electronic ballast.

Materials

Diffuser: Polycarbonate.
Wall support: Aluminum.

Packaging

1 Box
0,155 x 0,095 x 0,73 m.
Vol. 0,0107 m³.
Gross weight 2,1 Kg.
Net weight 1,65 Kg.

8090 01 Chrome

(Metallic finish)



8091

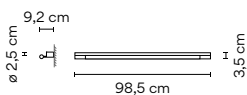

Light Source

1 x G5 230V 39W (T5).
Electronic ballast.

Materials

Diffuser: Polycarbonate.
Wall support: Aluminum.

Packaging

1 Box
0,16 x 0,095 x 1,03 m.
Vol. 0,0151 m³.
Gross weight 2,8 Kg.
Net weight 2,05 Kg.

8091 01 Chrome

(Metallic finish)



8092

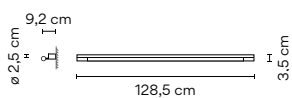

Light Source

1 x G5 230V 54W (T5).
Electronic ballast.

Materials

Diffuser: Polycarbonate.
Wall support: Aluminum.

Packaging

1 Box
0,155 x 0,95 x 1,33 m.
Vol. 0,0196 m³.
Gross weight 3 Kg.
Net weight 2,35 Kg.

8092 01 Chrome

(Metallic finish)

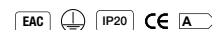

Millenium

8093

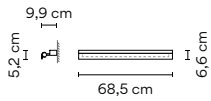

Light Source

— Or —
 1 x G5 MASTER LEDTube 600mm 8W.
 Or
 1 x G5 230V 24W (T5).

Electronic ballast.

Materials

Diffuser: Polycarbonate.
 Reflector: Aluminum.
 Wall support: Aluminum.

Packaging

1 Box
 0,15 x 0,095 x 0,73 m.
 Vol. 0,0107 m³.
 Gross weight 2,3 Kg.
 Net weight 1,85 Kg.

8093 01 Chrome
 (Metallic finish)



8094

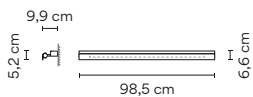

Light Source

—
 1 x G5 230V 39W (T5).

Electronic ballast.

Materials

Diffuser: Polycarbonate.
 Reflector: Aluminum.
 Wall support: Aluminum.

Packaging

1 Box
 0,15 x 0,095 x 1,03 m.
 Vol. 0,0151 m³.
 Gross weight 3,1 Kg.
 Net weight 2,35 Kg.

8094 01 Chrome
 (Metallic finish)



8095

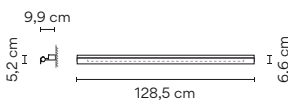

Light Source

— Or —
 1 x G5 MASTER LEDTube 1200mm 16,5W.
 Or
 1 x G5 230V 54W (T5).

Electronic ballast.

Materials

Diffuser: Polycarbonate.
 Reflector: Aluminum.
 Wall support: Aluminum.

Packaging

1 Box
 0,15 x 0,095 x 1,33 m.
 Vol. 0,0196 m³.
 Gross weight 3,4 Kg.
 Net weight 2,75 Kg.

8095 01 Chrome
 (Metallic finish)

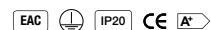

Domo

Design by Ramos & Bassols

Featuring a classic cylinder silhouette, Domo offers refined lighting effect, combining diffusion and reflection. The understated, LED-powered fixture has clean lines and a spherical shape that seamlessly blends into the ceiling architecture.



Ceiling

8200

Light Source

Ⓢ
3 x LED 2,1W 700mA.
LED 2700 K. CRI >80. 598 lm. 95 lm/W.
Driver Constant Current 700 mA.
100-240V. 50/60Hz.
/ 10: Dimmable: 100-240V. Bi-volt.
/ 12: Dimmable: 100-277V. Multivolt.

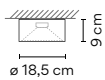

Surface fitting.

Personalization options available

- Finish customization.
(Available options: Vibia color palette).
 - LED 3000 K / 4000 K.
- Min. quantity, upcharge and extra lead time apply.

Materials

Diffuser: Polycarbonate.
Body: Aluminum.

Packaging

1 Box
0,26 x 0,26 x 0,26 m.
Vol. 0,0170 m³.
Gross weight 1,7 Kg.
Net weight 1,2 Kg.

8200 03 /10 White
(RAL 9010)

8200 03 /12 White
(RAL 9010)

EAC LED IP20 CE Bi-volt A**

8201

Light Source

Ⓢ
3 x LED 2,1W 700mA.
LED 2700 K. CRI >80. 598 lm. 95 lm/W.
Driver Constant Current 700 mA.
100-240V. 50/60Hz.
/ 10: Dimmable: 100-240V. Bi-volt.
/ 12: Dimmable: 100-277V. Multivolt.

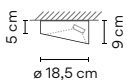

Surface fitting.

Personalization options available

- Finish customization.
(Available options: Vibia color palette).
 - LED 3000 K / 4000 K.
- Min. quantity, upcharge and extra lead time apply.

Materials

Diffuser: Polycarbonate.
Body: Aluminum.

Packaging

1 Box
0,26 x 0,26 x 0,26 m.
Vol. 0,0170 m³.
Gross weight 1,6 Kg.
Net weight 1,1 Kg.

8201 03 /10 White
(RAL 9010)

8201 03 /12 White
(RAL 9010)

EAC LED IP20 CE Bi-volt A**

8210

Light Source

Ⓢ
3 x LED 2,1W 700mA.
LED 2700 K. CRI >80. 598 lm. 95 lm/W.
Driver Constant Current 700 mA.
100-240V. 50/60Hz.
/ 10: Dimmable: 100-240V. Bi-volt.
/ 12: Dimmable: 100-277V. Multivolt.

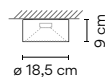

Surface fitting.

Personalization options available

- Finish customization.
(Available options: Vibia color palette).
 - LED 3000 K / 4000 K.
- Min. quantity, upcharge and extra lead time apply.

Materials

Diffuser: Polycarbonate.
Body: Aluminum.

Packaging

1 Box
0,26 x 0,26 x 0,26 m.
Vol. 0,0170 m³.
Gross weight 1,7 Kg.
Net weight 1,2 Kg.

8210 03 /10 Outside: Graphite. Inside: White
(RAL 7016)

8210 03 /12 Outside: Graphite. Inside: White
(RAL 7016)

EAC LED IP20 CE Bi-volt A**

45°

Design by Víctor Carrasco

45° fixture features a customised composition of vertical tubes that create a sculptural effect overhead. Suspended from the ceiling like sleek stalagmites, they create an array of glowing accent lighting points.

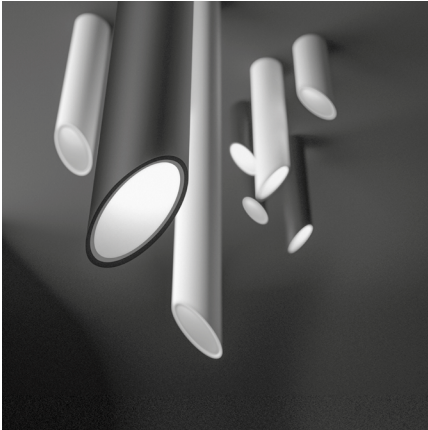

Ceiling

8250

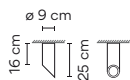

Light Source

②
1 x LED 6,1W 350mA.
LED 2700K. CRI >80. 714 lm. 109 lm/W.
Driver Constant Current 350 mA.
230V. 50Hz.
/ 13: Dimmable: 1-10V.
/ 15: Dimmable: Push.

Surface fitting.
It includes interchangeable diffusers,
mink or orange finishes.

Personalization options available

- LED 3000 K / 4000 K.
Min. quantity, upcharge and extra lead time apply.

Materials

Diffuser: Polycarbonate.
Tube: Aluminum.

Packaging

1 Box
0,21 x 0,21 x 0,48 m.
Vol. 0,0211 m³.
Gross weight 2,1 Kg.
Net weight 1,15 Kg.

8250 03 /13 White
(RAL 9016)

8250 03 /15 White
(RAL 9016)

8250 04 /13 Black
(RAL 9005)

8250 04 /15 Black
(RAL 9005)

8250 52 /13 Black oxide
(Satin bronze)

8250 52 /15 Black oxide
(Satin bronze)



8251

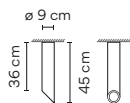

Light Source

②
1 x LED 6,1W 350mA.
LED 2700K. CRI >80. 714 lm. 109 lm/W.
Driver Constant Current 350 mA.
110-240V. 50/60Hz.
Dimming: 1-10V, Push.

Surface fitting.
It includes interchangeable diffusers,
mink or orange finishes.

Personalization options available

- LED 3000 K / 4000 K.
- Dimming: DALI.
Min. quantity, upcharge and extra lead time apply.

Materials

Diffuser: Polycarbonate.
Tube: Aluminum.

Packaging

1 Box
0,21 x 0,21 x 0,48 m.
Vol. 0,0326 m³.
Gross weight 2,9 Kg.
Net weight 1,95 Kg.

8251 03 /1B White
(RAL 9016)

8251 04 /1B Black
(RAL 9005)

8251 52 /1B Black oxide
(Satin bronze)



8252

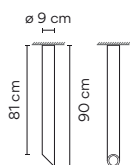

Light Source

②
1 x LED 6,1W 350mA.
LED 2700K. CRI >80. 714 lm. 109 lm/W.
Driver Constant Current 350 mA.
110-240V. 50/60Hz.
Dimming: 1-10V, Push.

Surface fitting.
It includes interchangeable diffusers,
mink or orange finishes.

Personalization options available

- LED 3000 K / 4000 K.
- Dimming: DALI.
Min. quantity, upcharge and extra lead time apply.

Materials

Diffuser: Polycarbonate.
Tube: Aluminum.

Packaging

1 Box
0,19 x 0,13 x 1,265 m.
Vol. 0,0312 m³.
Gross weight 6,25 Kg.
Net weight 4,75 Kg.

8252 03 /1B White
(RAL 9016)

8252 04 /1B Black
(RAL 9005)

8252 52 /1B Black oxide
(Satin bronze)



Match

Design by Jordi Vilardell & Meritxell Vidal

Based on the principle of co-creation, Match is a lighting collection that can be fully customised virtually. Sculptural light structures arranged chaotically and adapted to fit into the room and the space available.

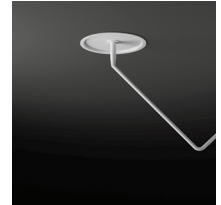
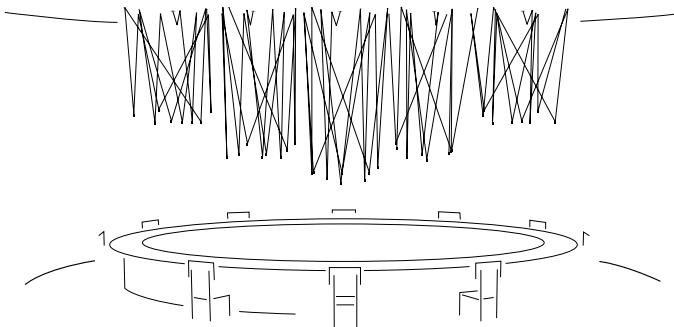
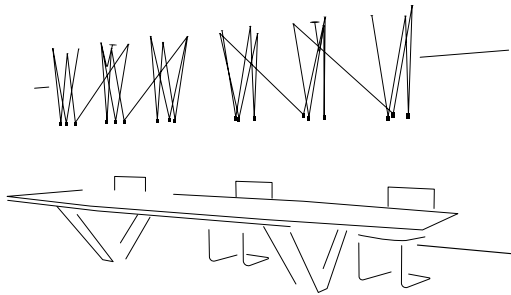
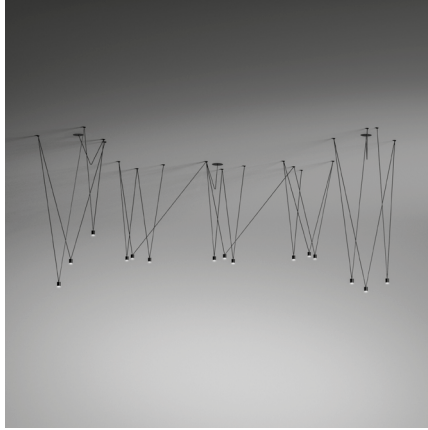

Built-in installation

- Electrical connection finials: the minimum height is 10 cm and the dimension of the cut-out is 10,5 cm.
- Nodes: the minimum height is 12 cm and the dimension of the cut-out is 4,5 cm.

Match

Create your product configuration quickly and easily at vibia.com

Go to vibia.com and discover the quickest, most effective way to configure a unique Match luminaire design.

It's necessary to make your personalized configuration on vibia.com to see prices and place orders.

Example 1:



Example 2:

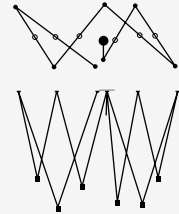

Example 3:

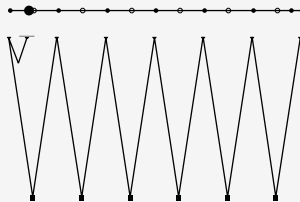

Example 4:

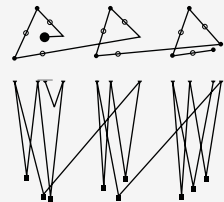

Example 5:

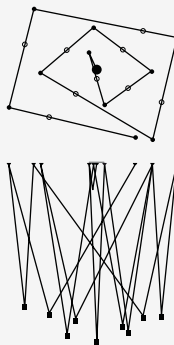

Example 6:

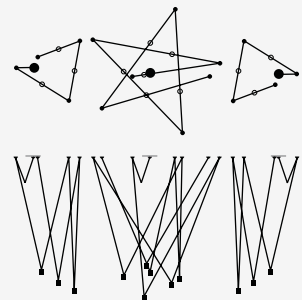

Pendants

Light Source



LED 2.1W 700mA.
LED 2700 K. CRI >80. 199 lm. 95 lm/W.
Driver Constant Current 700 mA.
110-240V. 50/60Hz.
Dimming: DALI, 1-10V, Push.

Built-in.

Personalization options available

- Configuration layout at vibia.com
- Dimming: Casambi.
Min. quantity, upcharge and extra lead time apply.

Materials

Head: Aluminum.
Canopy Plate: Steel.
Rods: Steel.

03 Graphite

(RAL 9016)

18 White

(RAL 7016)



PLACE ORDER ONLINE AT WWW.VIBIA.COM





Bulbs

Halogens

Mains voltage







900068.	G9 230V 33W Eco	
900026.	G9 230V 48W Eco	
900033.	G9 230V 60W Eco	
900054.	PAR 30 E27 230V 100W	
900220.	R7s 80mm 230V 80W Eco	
900321.	R7s 80mm 230V 120W Eco	
900021.	R7s 117mm 230V 230W Eco	
900121.	R7s 117mm 230V 400W Eco	

LED

900103.	Core Pro LEDbulb E27 230V 9W	
900100.	Led G9 230V 3W 2800K MEGAMAN	
900106.	LED STAR CLASSIC P40 E14 230V 6W	
900105.	LEDspot PAR30S E27 230V 9,5W	
900102.	MASTER LEDbulb E27 230V 15W	

Fluorescent

Compact fluorescent

900022.	2G11 230V 18W	
900023.	2G11 230V 24W	
900024.	2G11 230V 36W	
900084.	COMPACT FLUORESCENT E14 230V 15W (MEGAMAN LILIPUT PLUS or similar)	
900085.	COMPACT FLUORESCENT E27 230V 11W	
900083.	COMPACT FLUORESCENT E27 230V 15W	
900600.	COMPACT FLUORESCENT E27 230V 23W	

Fluorescent tube

900027.	G5 230V 24W (T5)	
900028.	G5 230V 39W (T5)	
900031.	G5 230V 54W (T5)	
900071.	2GX13 230V 22W (T5C)	
900070.	2GX13 230V 40W (T5C)	
900035.	2GX13 230V 55W (T5C)	
900072.	2GX13 230V 60W (T5C)	

Bulbs: net prices, without discount

Professional area at vibia.com

A new way of Working

We believe in cooperation and we bring you new ways to collaborate and online tools at vibia.com that we will help to work together efficiently. We propose a new way of working to have successful lighting projects.

Download all the information you need

Download and export all product information you need for your projects in one click:



Spec sheet

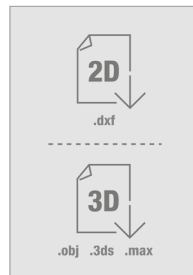

2D, 3D

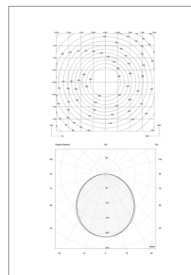

Photometry



HD images

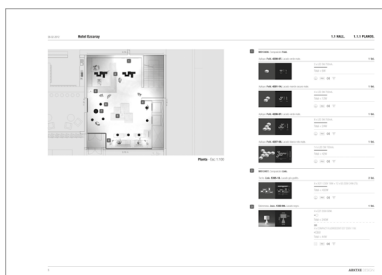

Project report

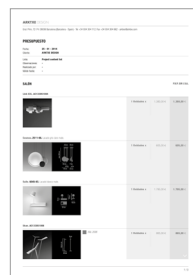

Budgets



Product configuration spec sheet

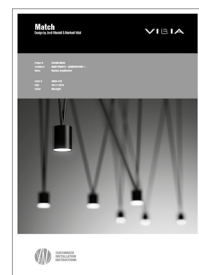

Installation instructions

Check product availability and place orders

Check product availability, manage deadlines and send your orders online.

Keep a complete tracking of your orders from your Professional Area account.

The screenshot shows the Vibia Professional Area interface. At the top, there are navigation links: Products, Inspiration, Downloads, Where to buy, and Professional area. Below this is a header with 'MY PROFESSIONAL AREA', 'PROJECTS', and 'ORDERS'. The main content area is titled 'gg - PR00176384' and contains a progress bar with four steps: 'CREATE AND EDIT YOUR PROJECT', 'DOWNLOAD DOCUMENTATION AND GENERATE QUOTES', 'REQUEST SUPPORT AND PROJECT REGISTRATION', and 'CHECK AVAILABILITY AND PLACE ORDERS'. A 'HOW TO PLACE AN ORDER?' section shows three numbered steps: 1. Choose your products from reference, catalogue or projects. 2. Check the availability and arrange the delivery dates. 3. Confirm your order. Below this, there are three main sections: '1 SELECT THE PRODUCTS', '2 ARRANGE DELIVERY DATES', and '3 YOUR ORDER CONFIRMATION'. The 'SELECT THE PRODUCTS' section includes a search bar for 'Product reference (4 digits)' and a 'Ref.' field. A 'Catalogue' sidebar lists categories: Hanging lamps, Floor Lamps, Table Lamps, Ceiling Lamps, Wall Lamps, Bathrooms Lamps, and Outdoor lamps. The 'ARRANGE DELIVERY DATES' section shows a form for 'Internal order No.' and 'Comments', with a 'SAVE ORDER DRAFT' button. Below the form, the total price is 'TOTAL 1.865,00 €' (Net prices (client discount included)) and there is an 'ARRANGE DELIVERY DATES' button. The 'YOUR ORDER CONFIRMATION' section shows a list of selected products with their availability and a quantity selector. A large grey circle highlights the product list and the 'TOTAL 1.865,00 €' section.

Vibia - Light your way

Item coding

ITEM CODING

Reference			
1510	18	/1	B.

Model

4 digits

Finish

2 digits

LED color
temperature

1 digit

0 > Without LED
1 > 2700 K
2 > 3000 K
3 > 3500 K
4 > 4000 K

Dimming
typology

1 digit

0 > Dimmable: No
1 > DALI
2 > 0-10V
3 > 1-10V
4 > TRIAC
5 > Push
6 > Sensor
A > 1+3+5 (DALI + 1-10V + Push)
B > 3+5 (1-10V + Push)
C > 1+3 (DALI + 1-10V)
Z > Casambi*
M > Remote driver

*Casambi refers to wireless dimming solutions.
 Ask for more information.

**Should you need a non standard product.
 Please, request sales conditions.**

Glossary

CE

Product complying with the EN60598-1 and EN60598-2-1 European regulation.

IP

Level of protection. Electrical products are prepared to avoid solids and liquids from getting in contact with the electrical parts. Such resistance is expressed as IP followed by two digits: the first digit indicates the level of resistance to solid objects and the second one to liquids. The scale goes from IP20 to IP68.

IP20

Product protected against solid object as big as or bigger than 12 mm. No protection against water.

IP64

Dust-tight product. Protected against water spray.

IP65

Dust-tight product. Protected against water trickles.

IP66

Dust-tight product. Protected against water spurts.

Insulation class



Class I. Product with an additional protection cable (grounds).



Class II. Product protected against electric shock having a double insulation. No grounds.



Class III. Product protected against electric shock based on a very-low voltage system. No grounds.

Flammable surfaces



Product suitable to be installed on any kind of surface (EN 60598).



Product that **CANNOT** be in contact with normally-flammable materials (wood or others).

Bi-volt

Valid for the range 110V-230V, 50-60Hz.

Li-ion

Contains lithium-ion battery. Li-Ion battery must be disposed of into labeled containers, returned to special waste collection points or retailers of electrical equipment.

Cut out



Property for embedding dimension.

No electronic equipment included



The lamp does not include any electronic equipment (transformer, driver, ballast...).

Integrated Dimmer

Dimmer

Lamp that has a integrated dimmer.

EU Energetic label

More Efficacy



Less Efficacy

Light source information

CRI

Color rendering index.

K

Color temperature.

lm

Lumen, unit of measurement of luminous flux.

lm/W

Light source performance. Relationship between the luminous flux (lm) and the power consumed (W) by the source.

EAC

Product complying with TP TC 004/2011 and TP TC 020/2011. Custom Union Regulation.

LED

LED included.

Lighting control systems

1 Push Dimming

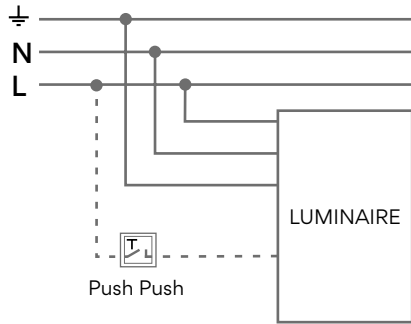

2 1-10V System Dimming

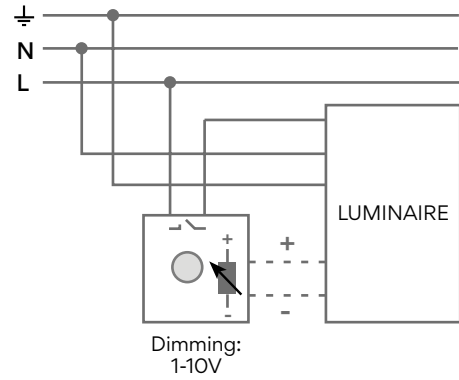

3 DALI System Dimming

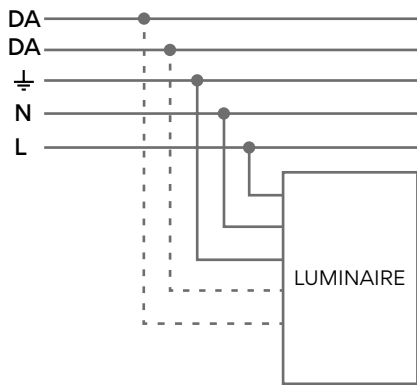

4 Casambi Dimming

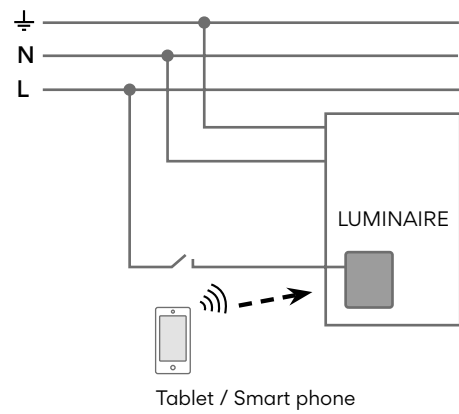

5 TRIAC Dimming

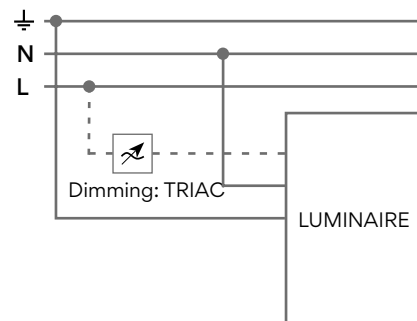

⏏	Ground
N	Neutral
L	Line
DA	DALI-Digital Signal

Very important

Vibia Lighting S.L.U. has the right to change any model or finish of the products included in the picture catalogue without any previous notice.

Vibia Lighting, S.L.U.

Office

Progrés 4-6.

08850 Gavà (Barcelona).

International Tel +34 934 796 971. Fax +34 934 782 026.

vibia@vibialighting.com

vibia.com

COPYRIGHT© VIBIA LIGHTING S.L.U. ALL RIGHTS RESERVED.

