



nueva colección
new collection

2020





Let's get brighter

KELMAX

vetlo inak...

Rastislav Sabo - KELMAX

Košovská cesta 24
971 01 Prievidza

e-mail: kelmax@kelmax.sk

www.kelmax.sk

tel.: +421 944 919 288



Entender la esencia de cada uno, es emprender un viaje.

El nuestro empieza y acaba en esta orilla del Mediterráneo.
Lugar y gente de costa que se echa a la mar. Mira lejos. Y lleva
su saber a otros puertos.
Y entre esa gente: esta familia. Porque, ante todo, somos eso.
Familia. Por legado y por actitud.

Understanding the essence of each one is to undertake a journey.

Ours begins and ends on this shore of the Mediterranean.
Where the light shines with a special purity and intensity, lighting
everything extremely clearly and flawlessly. We take this knowledge to
other ports, other people.
And among those people: this family. Because, above all, we are that.
Family. By legacy and by attitude.

BPM Lighting

ALBERTA INSIDE

La J



Let's get brighter

Perfección
tiene forma circular.



ALBERTA DUE

Perfection
has a circular shape.

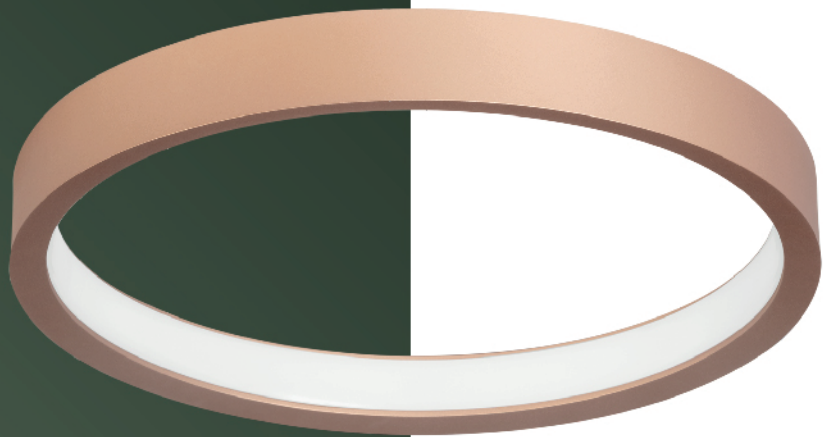

ALBERTA INSIDE



OKKO

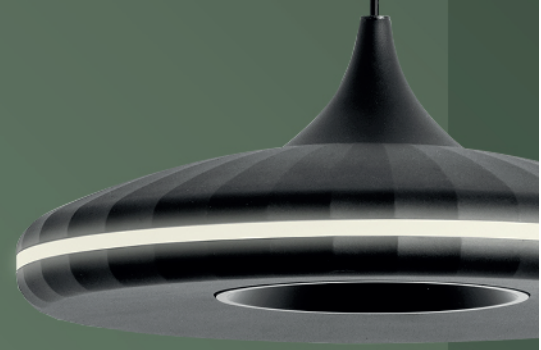

Luminarias Co Stat

SUBLIM
composition

SUBLIM
two sizes



KIERA



IRIS



FACE

Pendantes de Vanguardia State-of-the-Art Pendant Lights



Let's get brighter

KIERA CEM



GALANTA





Creando nuevas formas
Creating new forms



BPMLighting®

Let's get brighter



formas de iluminar.
new ways of lighting



ALARIK SLIM

Infinitas posibilidades en versión mini
Infinite possibilities in mini version





La Experiencia Outdoor

Los espacios al aire libre destacarán con piezas únicas diseñadas para que la luz se disipe armoniosamente, como parte de una pieza integrada en el ambiente.

The Outdoor Experience

The outdoor spaces will stand out with unique pieces designed to diffuse the light harmoniously, as part of a single unit integrated into the surrounding.



Let's get brighter

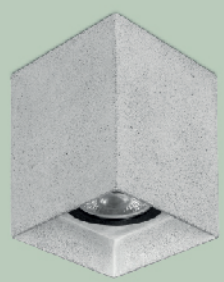

NOCTÚA
OUT



ARA
OUT

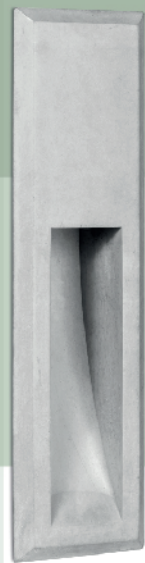

DRACO
OUT

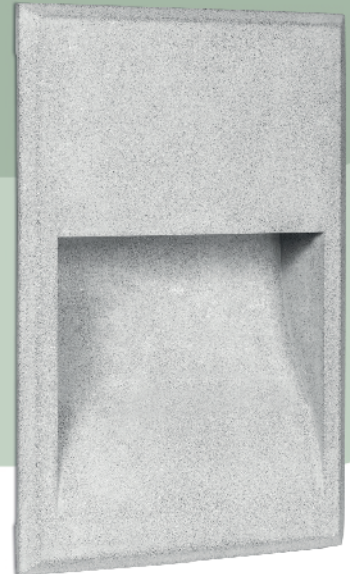

ZAHARA
OUT

REDUGER®

TECH SOLUTION UGR<19



Let's get brighter



TECH SOLUTION UGR<19

before REDUGER



Beam Diameter (m) | Beam Diameter (m)

CP1 - C180 (180°) | B200 - C200 (200°)

CCD - C270 (270°) | B200 - C270 (270°)

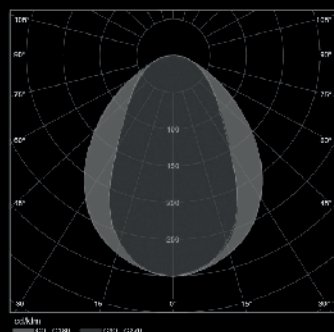

0.5m | 1.0m | 1.5m | 2.0m | 2.5m | 3.0m

CP1 - C180 | B200 - C200

after REDUGER

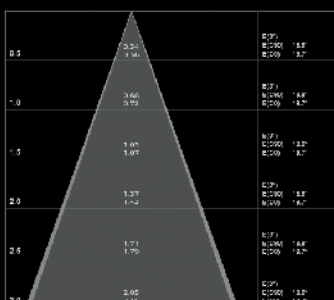

Beam Diameter (m) | Beam Diameter (m)

CP1 - C180 (180°) | B200 - C200 (200°)

CCD - C270 (270°) | B200 - C270 (270°)

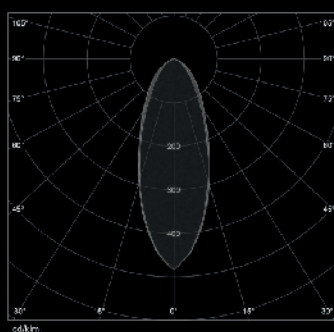

0.5m | 1.0m | 1.5m | 2.0m | 2.5m | 3.0m

CP1 - C180 | B200 - C200

BPM Lighting presenta el Sistema REDUGER a través de un dispositivo que añadido a nuestras luminarias focaliza el haz de luz y proporciona un UGR, 100% compatible con la normativa europea UNE 12464-1.

¡Descúbrelo!

BPM Lighting introduces REDUGER, a patented device that being added to our luminaires, focuses the light beam and provides an optimum UGR, 100% compatible with European standards UNE 12464-1

Find out!



Let's get brighter

Es nuestra mentalidad, especialmente en estos tiempos de incertidumbre en los que trabajaremos juntos para salir más fuertes, más resistentes, más conectados, más empáticos, más comprometidos, más flexibles ... ¡MÁS BRILLANTES!
¡Juntos, seremos más brillantes!

Let's get brighter

Let's get brighter, It's our mindset.

In these times of uncertainty, we will work together to come out stronger, more resilient, more connected, more thoughtful, more committed, more flexible... BRIGHTER!
Together, we will get brighter!

let's co-create
with ALARIK SLIM

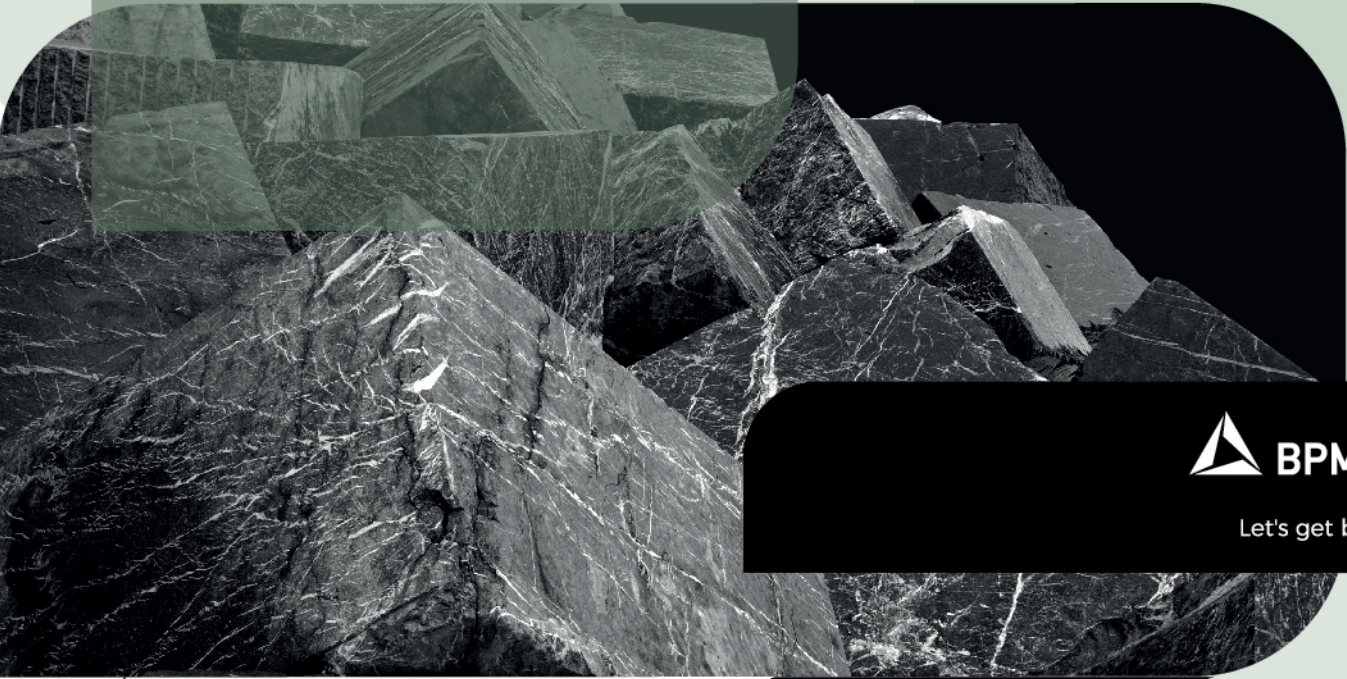

 **BPM**Lighting®

Let's get brighter



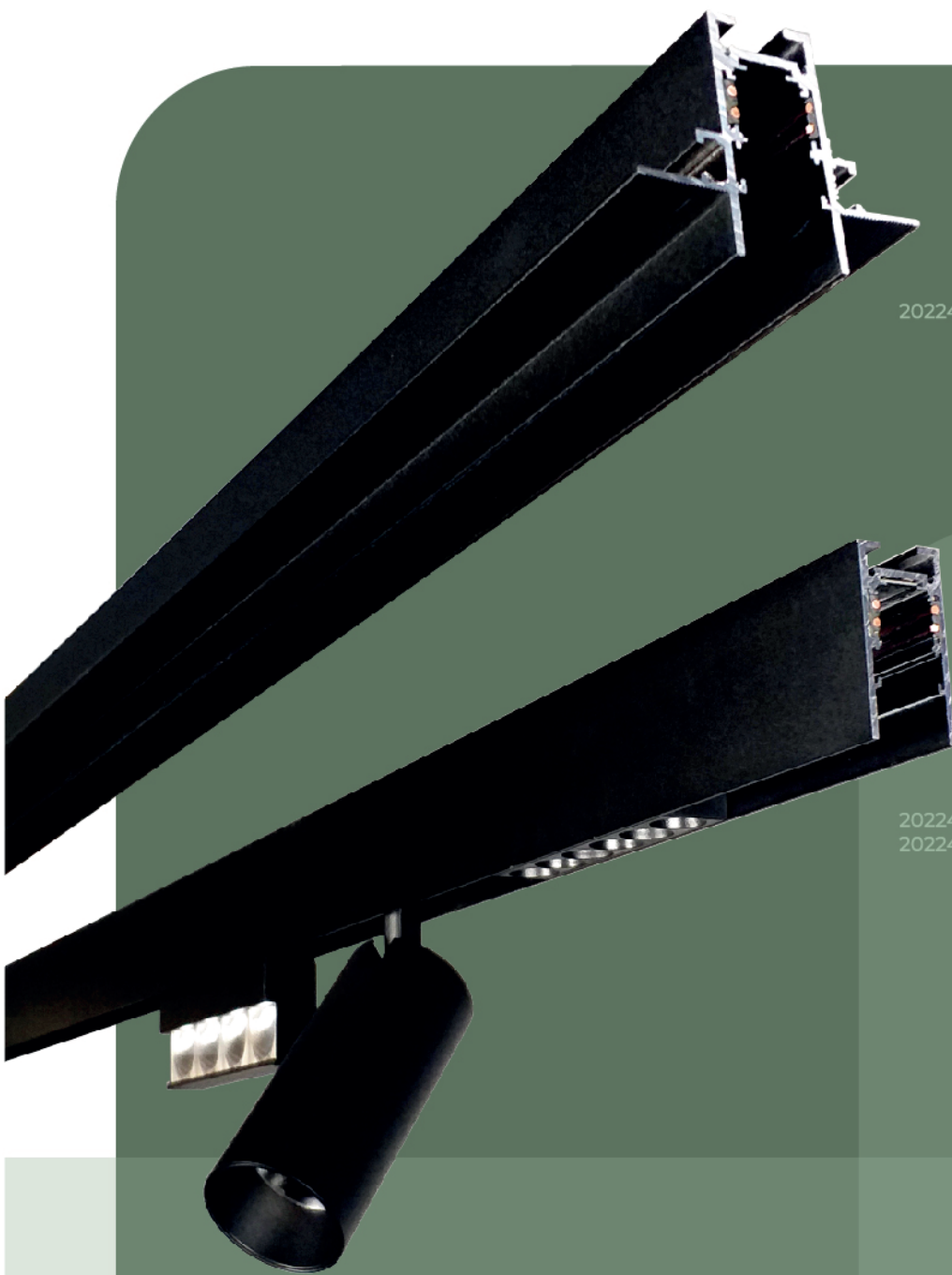

20224.TR

20224.SR
20224.PN

ALARIK SLIM

Infinite possibilities in mini version



Let's get brighter



Let's get brighter

ALARIK SLIM

Infinite possibilities in mini version



GENERAL DETAILS

REFERENCE:	20224
INSTALLATION:	Trimless Surface Pendant
EXTERNAL FINISH:	White · Black
MATERIAL:	Aluminium
IP DEGREE:	IP40
IK:	IK06
FORM:	Square
REGULATION:	DALI 1..10
UTILIZATION:	Indoor
WARRANTY:	5 years

GENERAL DIMENSIONS

20224.SR : 26.5 X 54 X L mm.
20224.PN : 26.5 X 54 X L mm.
20224.TR : ext (70.1 X 54) 26.5 X 54 X L mm.

MAXIMUM CABLE LENGTH 2000 mm

20224.SR
20224.PN

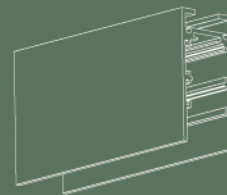
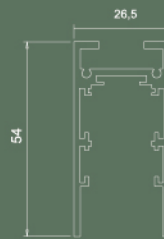

20224.TR

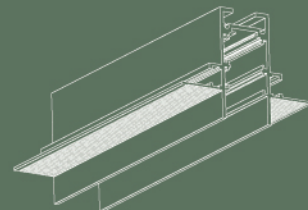
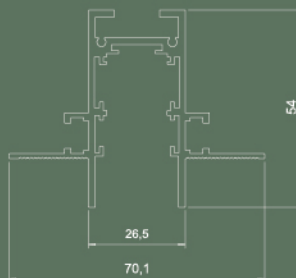



SLIM PATRICIA
S | M | L

FOR ALARIK SLIM

 **BPM**Lighting®

Let's get brighter

CE 



Let's get brighter

SLIM PATRICIA

S | M | L

FOR ALARIK SLIM

GENERAL DETAILS

REFERENCE:	11544 S 11545 M 11546 L
INSTALLATION:	ALARIK SLIM MODULE
EXTERNAL FINISH:	.BK Black .W White
MATERIAL:	Aluminium
IP DEGREE:	IP20
IK:	IK06
FORM:	Round
LIGHT DIRECTION:	Oscillation
BEAM ANGLE S M :	15° 38° 60°
BEAM ANGLE L :	15° - 36° 36° - 60°

GENERAL DIMENSIONS

DIMENSIONS:	CROQUIS
MINIMUM DISTANCE TO ILLUMINATED OBJECT:	0.5 m

ELECTRICAL DETAILS

LAMP:	LED
LED TYPE:	BRIDGELUX
PROTECTION CLASS:	
ENERGETIC EFFICIENCY:	A+
CONSTANT VOLTAGE:	48 V
VOLTAGE:	230 V
LIFE TIME:	50.000 h
LUMEN MAINTENANCE:	L80_B10: 50000
CRI:	≥90
MACADAM:	<3



CE 



Let's get brighter

SLIM PATRICIA S | M | L

FOR ALARIK SLIM



SLIM PATRICIA S 11544

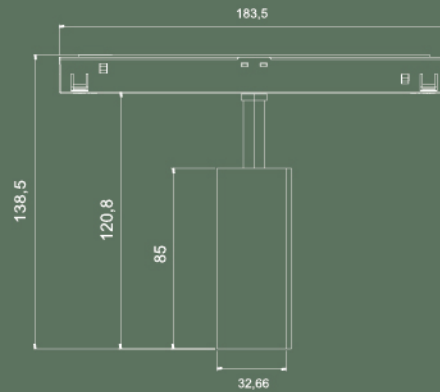

		EFFICIENCY	LUMENS
POWER	8W	EFF 2700K: 75 lm/w	2700K lm: 579 lm
		EFF 3000K: 79 lm/w	3000K lm: 607 lm
		EFF 4000K: 90 lm/w	4000K lm: 695 lm



SLIM PATRICIA M 11545

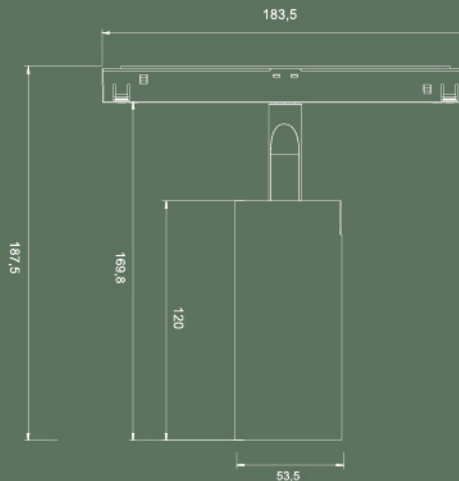

		EFFICIENCY	LUMENS
POWER	13W	EFF 2700K: 90 lm/w	2700K lm: 1173 lm
		EFF 3000K: 90 lm/w	3000K lm: 1181 lm
		EFF 4000K: 93 lm/w	4000K lm: 1207 lm

CE 

 **BPM**Lighting®

Let's get brighter

SLIM PATRICIA S | M | L

FOR ALARIK SLIM



SLIM PATRICIA L 11546

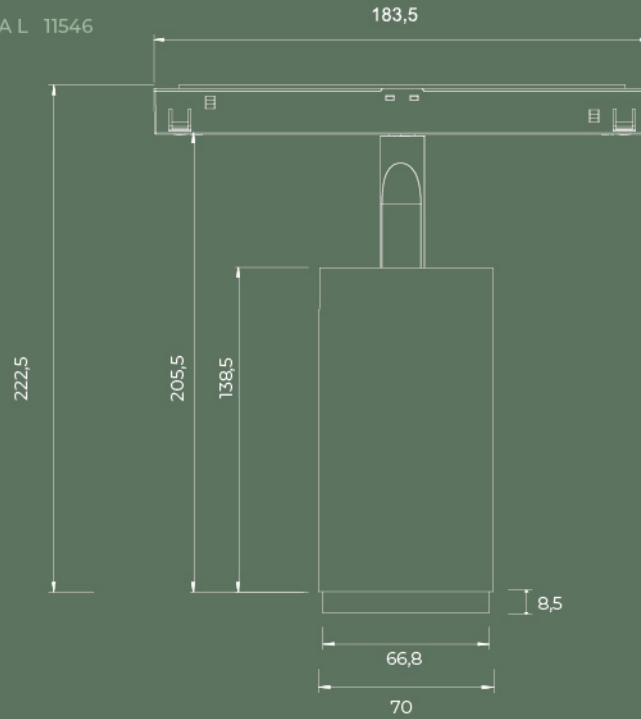

POWER	22W	EFFICIENCY		LUMENS	
		EFF 2700K:	92 lm/w	2700K lm:	2038 lm
		EFF 3000K:	104 lm/w	3000K lm:	2254 lm
		EFF 4000K:	105 lm/w	4000K lm:	2320 lm

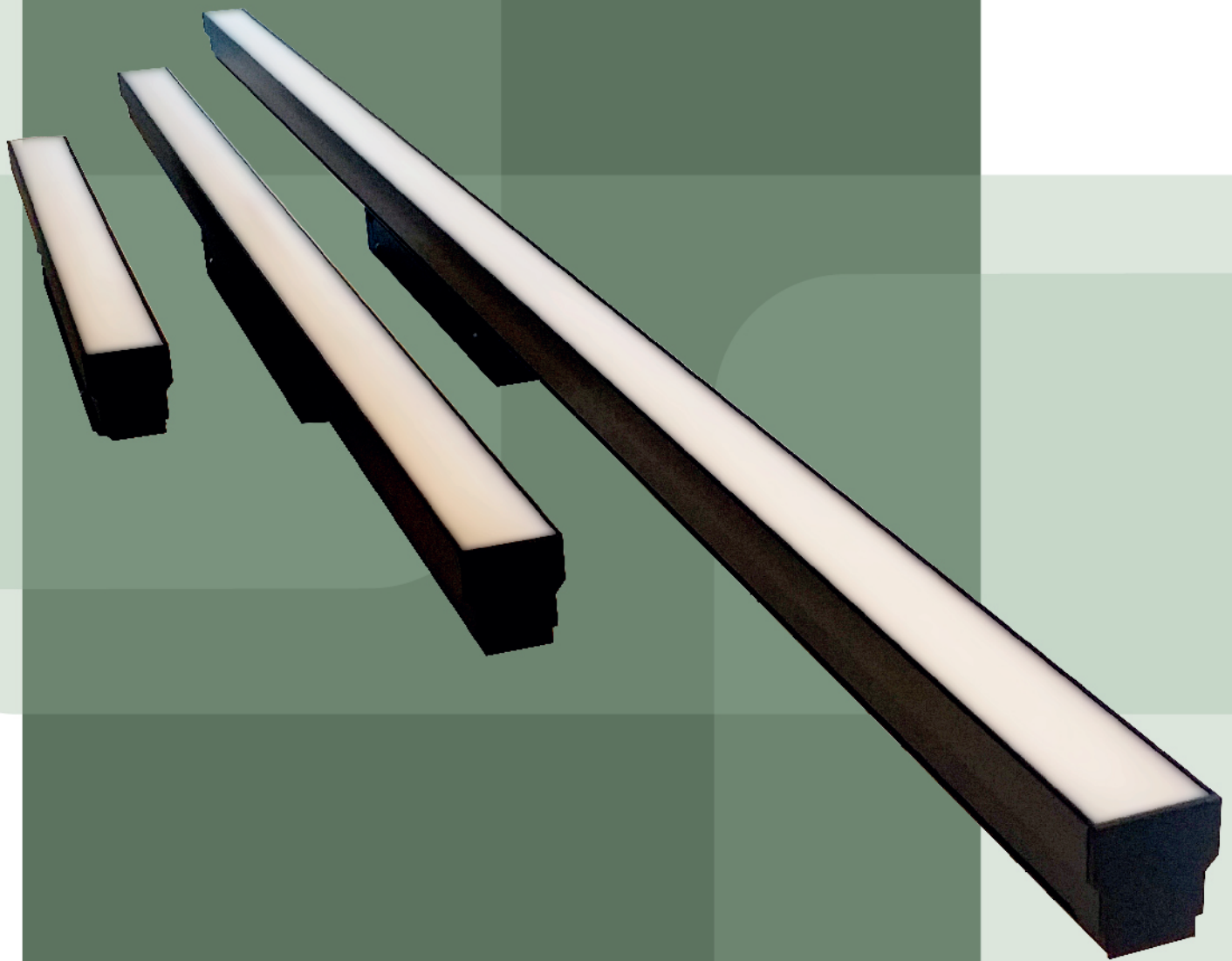

SLIM LED MODULES
FOR ALARIK SLIM



Let's get brighter



Let's get brighter

SLIM LED MODULES

FOR ALARIK SLIM



GENERAL DETAILS

REFERENCE:	11549.01 11549.02 11549.03
INSTALLATION:	ALARIK SLIM MODULE
EXTERNAL FINISH:	.BK Black
MATERIAL:	Aluminium
IP DEGREE:	IP20
IK:	IK06
LIGHT DIRECTION:	Fixed
OPTIC COVER:	Opal

GENERAL DIMENSIONS

DIMENSIONS:	11549.01: 303 X 43 X 22,8 mm. 11549.02 : 603 X 43 X 22,8 mm. 11549.03 : 903 X 43 X 22,8 mm.
MINIMUM DISTANCE TO ILLUMINATED OBJECT:	0,5 m

ELECTRICAL DETAILS

LAMP:	LED
LED TYPE:	OSRAM
PROTECTION CLASS:	
ENERGETIC EFFICIENCY:	A+
CONSTANT VOLTAGE:	48 V
VOLTAGE:	230 V
LIFE TIME:	35.000 h
LUMEN MAINTENANCE:	L80_B10: 35000
CRI:	≥90
MACADAM:	<3



Let's get brighter

SLIM LED MODULES

FOR ALARIK SLIM



11549.01



POWER	8,9W	EFFICIENCY		LUMENS	
		EFF 2700K:	62 lm/w	2700K lm:	558 lm
		EFF 3000K:	63.6 lm/w	3000K lm:	560 lm
		EFF 4000K:	80 lm/w	4000K lm:	604 lm

15549.02

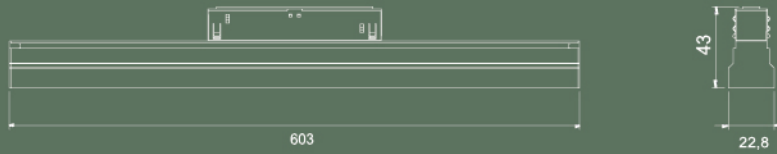

POWER	17.8W	EFFICIENCY		LUMENS	
		EFF 2700K:	62 lm/w	2700K lm:	1115 lm
		EFF 3000K: <td>63 lm/w</td> <td>3000K lm: <td>1120 lm</td> </td>	63 lm/w	3000K lm: <td>1120 lm</td>	1120 lm
		EFF 4000K: <td>80 lm/w</td> <td>4000K lm: <td>1208 lm</td> </td>	80 lm/w	4000K lm: <td>1208 lm</td>	1208 lm

15549.03



POWER	20.63W	EFFICIENCY		LUMENS	
		EFF 2700K:	62 lm/w	2700K lm:	1670 lm
		EFF 3000K: <td>63 lm/w</td> <td>3000K lm: <td>1680 lm</td> </td>	63 lm/w	3000K lm: <td>1680 lm</td>	1680 lm
		EFF 4000K: <td>80 lm/w</td> <td>4000K lm: <td>1812 lm</td> </td>	80 lm/w	4000K lm: <td>1812 lm</td>	1812 lm

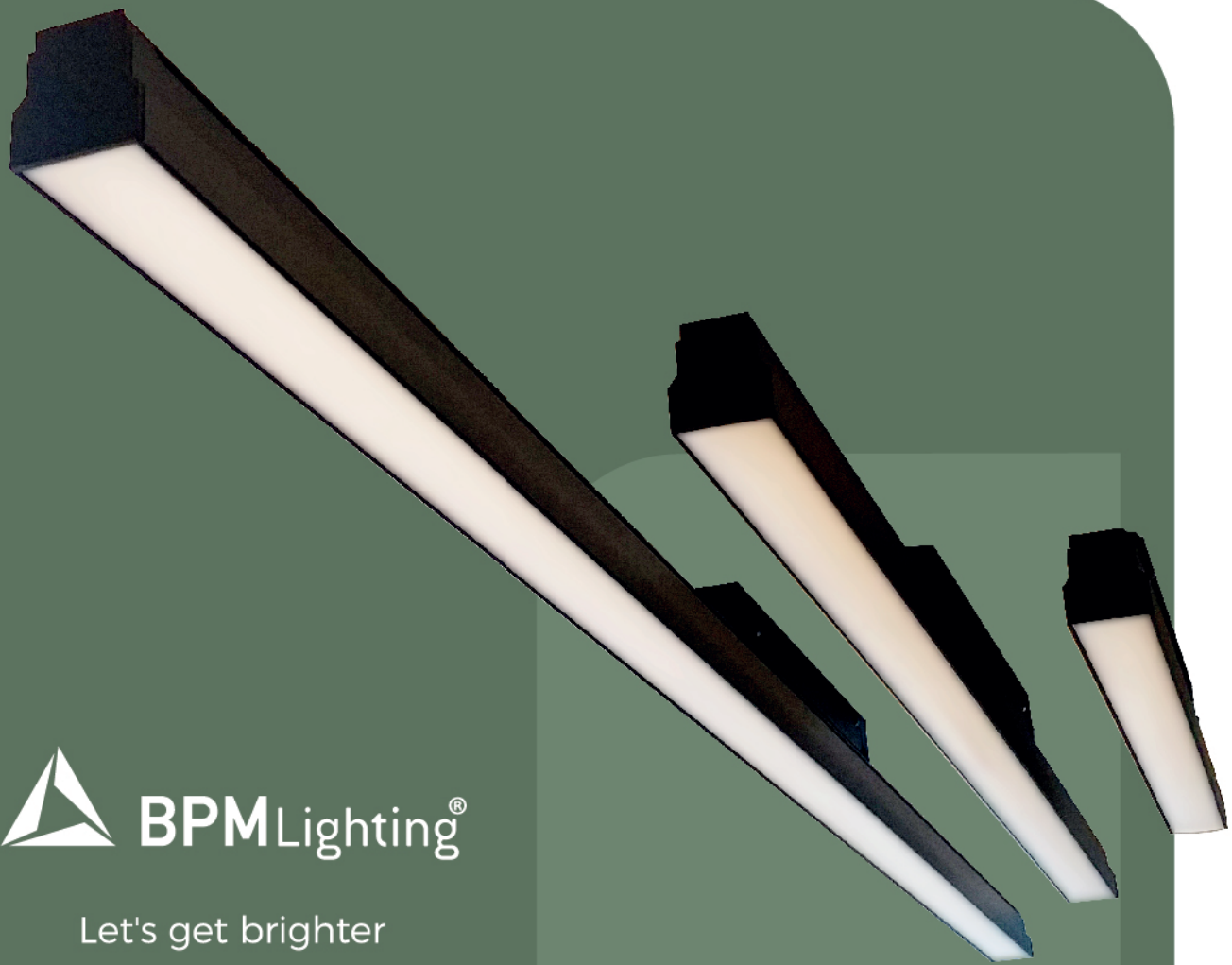

Let's get brighter



SLIM LENSES
FOR ALARIK SLIM



Let's get brighter

CE 



Let's get brighter



SLIM LENSES

FOR ALARIK SLIM

GENERAL DETAILS

REFERENCE:	11548.06 11548.12
INSTALLATION:	ALARIK SLIM MODULE
EXTERNAL FINISH:	.BK Black
MATERIAL:	Aluminium
IP DEGREE:	IP20
IK:	IK06
BEAM ANGLE:	15° 38°
LIGHT DIRECTION:	Fixed

GENERAL DIMENSIONS

DIMENSIONS:	* CROQUIS
MINIMUM DISTANCE TO ILLUMINATED OBJECT:	0.5 m

ELECTRICAL DETAILS

LAMP:	LED
LED TYPE:	OSRAM
PROTECTION CLASS:	
ENERGETIC EFFICIENCY:	A+
CONSTANT VOLTAGE:	48 V
VOLTAGE:	230 V
LIFE TIME:	35.000 h
LUMEN MAINTENANCE:	L80_B10: 35000
CRI:	≥90
MACADAM:	<3



Let's get brighter

SLIM LENSES

FOR ALARIK SLIM



11548.12

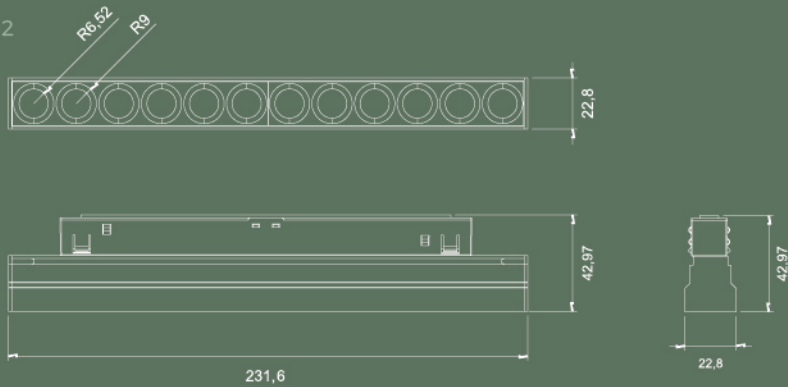

POWER		EFFICIENCY	LUMENS
18 W	EFF 2700K:	74 lm/w	2700K lm: 1320 lm
	EFF 3000K:	83 lm/w	3000K lm: 1511 lm
	EFF 4000K:	93 lm/w	4000K lm: 1654 lm

11548.06

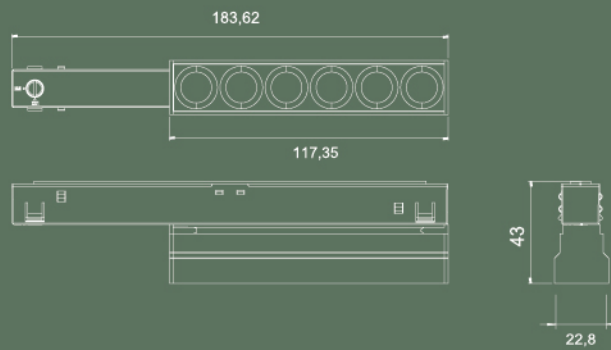

POWER		EFFICIENCY	LUMENS
9 W	EFF 2700K:	74 lm/w	2700K lm: 660 lm
	EFF 3000K:	83 lm/w	3000K lm: 750 lm
	EFF 4000K:	93 lm/w	4000K lm: 827 lm

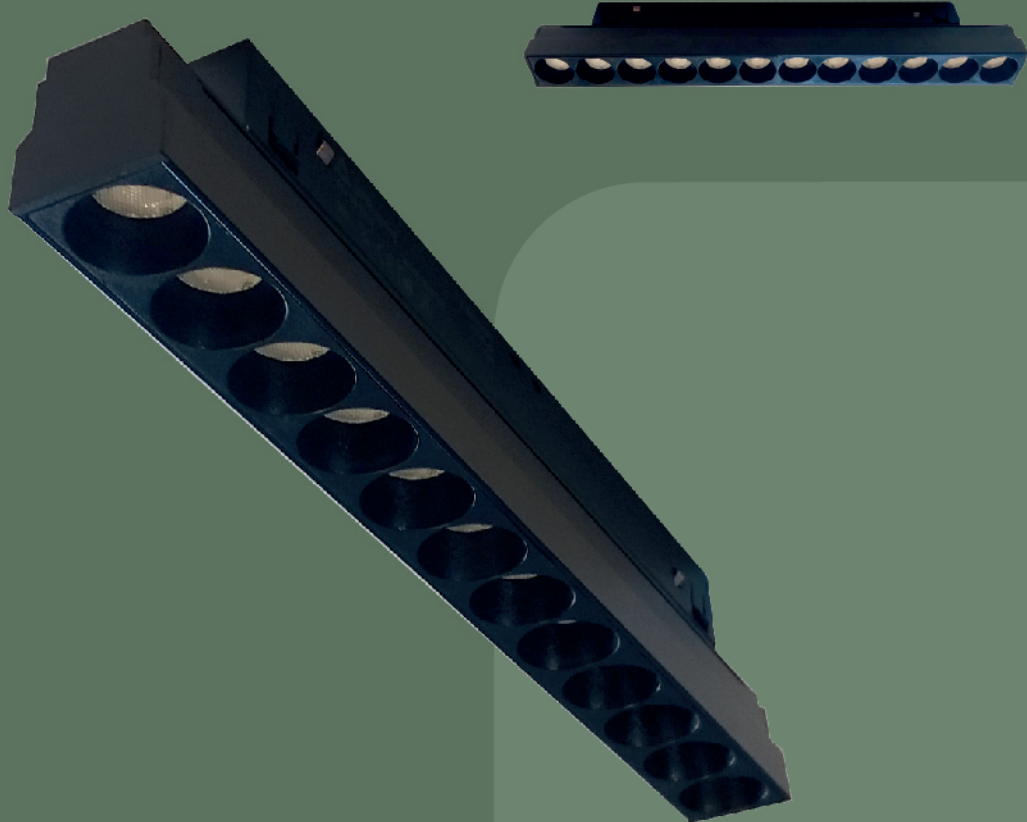

Let's get brighter



SLIM MOTION LENSES
FOR ALARIK SLIM



Let's get brighter



Let's get brighter

SLIM MOTION LENSES

FOR ALARIK SLIM



GENERAL DETAILS

REFERENCE:	11547
INSTALLATION:	ALARIK SLIM MODULE
EXTERNAL FINISH:	.BK Black
MATERIAL:	Aluminium
IP DEGREE:	IP20
IK:	IK06
BEAM ANGLE:	15° 38°
LIGHT DIRECTION:	Oscillation

GENERAL DIMENSIONS

DIMENSIONS:	* CROQUIS
MINIMUM DISTANCE TO ILLUMINATED OBJECT:	0.5 m

ELECTRICAL DETAILS

LAMP:	LED
LED TYPE:	OSRAM
PROTECTION CLASS:	⚡
ENERGETIC EFFICIENCY:	A+
CONSTANT VOLTAGE:	48 V
VOLTAGE:	230 V
LIFE TIME:	35.000 h
LUMEN MAINTENANCE:	L80_B10: 35000
CRI:	≥90
MACADAM:	<3

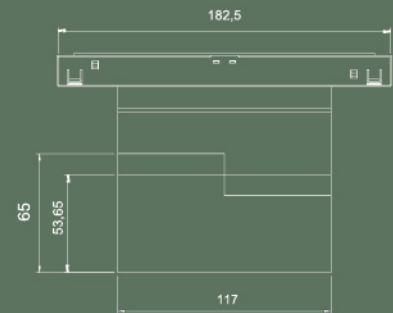

POWER	9,18 W	EFFICIENCY		LUMENS	
		EFF 2700K:	74 lm/w	2700K lm:	660 lm
		EFF 3000K:	82,86 lm/w	3000K lm:	750 lm
		EFF 4000K:	93 lm/w	4000K lm:	827 lm



SLIM WALL WASHER

FOR ALARIK SLIM



Let's get brighter



Let's get brighter

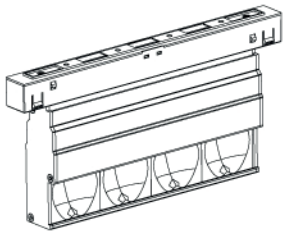

SLIM WALL WASHER

FOR ALARIK SLIM

GENERAL DETAILS

REFERENCE:	11550
INSTALLATION:	ALARIK SLIM MODULE
EXTERNAL FINISH:	.BK Black
MATERIAL:	Aluminium
IP DEGREE:	IP20
IK:	IK06
BEAM ANGLE:	Wall washer
LIGHT DIRECTION:	Fixed

GENERAL DIMENSIONS

DIMENSIONS:	* CROQUIS
MINIMUM DISTANCE TO ILLUMINATED OBJECT:	0.5 m

ELECTRICAL DETAILS

LAMP:	LED
LED TYPE:	CREE
PROTECTION CLASS:	⏏
ENERGETIC EFFICIENCY:	A+
CONSTANT VOLTAGE:	48 V
VOLTAGE:	230 V
LIFE TIME:	35.000 h
LUMEN MAINTENANCE:	L80_B10: 35000
CRI:	≥90
MACADAM:	<3

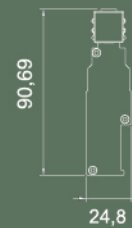
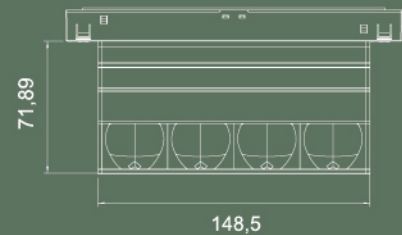

		EFFICIENCY	LUMENS
POWER	13W	EFF 2700K: 85 lm/w	2700K lm: 1100 lm
		EFF 3000K: 87 lm/w	3000K lm: 1169 lm
		EFF 4000K: 100 lm/w	4000K lm: 1251 lm



ALARIK SLIM
ACCESORIES



Let's get brighter

ALARIK SLIM

ACCESORIES

10246.CA

POWER FEEDER UNIT
2000 x 17 x 16 BLACK

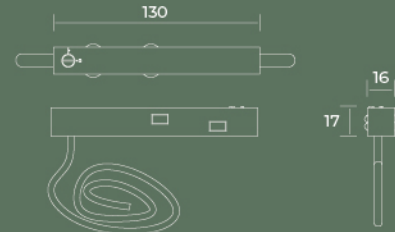

10246.UA

ANGLE FLEXIBLE JOINT
130 x 17 x 16 BLACK

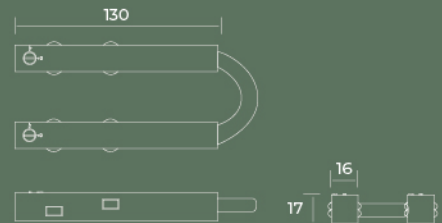

10246.UL

LINEAR JOINT
160 x 17 x 22 BLACK



10246.PK

PENDANT KIT
(CEILING FASTENER
CABLE SUSPENSION)
2000 x 35 x 22,5 BLACK

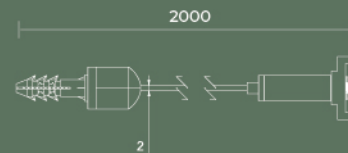

10246.PKDB

PENDANT KIT
WITH DRIVER BOX
2000 x 36 x 54 BLACK

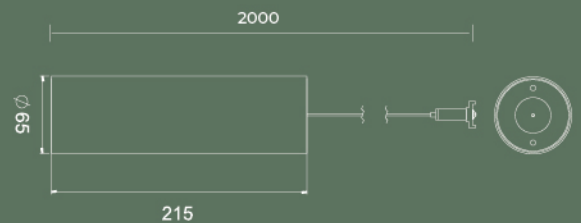

ALARIK SLIM COVER KIT

CK29.TR

COVER KIT
TRIMLESS

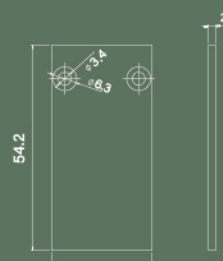

CK29.SR CK29.PN

COVER KIT
SURFACE
PENDANT

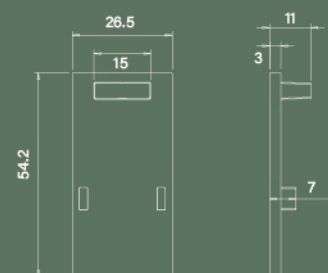



KIERA
Serene and Atemporal

 **BPM**Lighting®

Let's get brighter

CE 



Let's get brighter



KIERA

FAMILY

GENERAL DETAILS

REFERENCE:	20204 S M L
INSTALLATION:	Pendant
EXTERNAL FINISH:	White · Black
MATERIAL:	Aluminium
IP DEGREE:	IP20
FORM:	Round
IK:	IK06
LIGHT DIRECTION:	Fixed
REGULATION:	1..10V · Push · DALI · Non Dimm
BEAM ANGLE:	38°
UTILIZATION:	Indoor
WARRANTY:	5 years

GENERAL DIMENSIONS

	20204 S : Ø56 x 57 mm
	20204 M : Ø75 x 81 mm
	20204 L : Ø100 x 114,8 mm
MAXIMUM CABLE LENGTH	3000 mm
MINIMUM DISTANCE TO ILLUMINATED OBJECT:	0.5 m

ELECTRICAL DETAILS

LAMP:	LED
PROTECTION CLASS:	
ENERGETIC EFFICIENCY:	A++
DRIVER:	Included (remote if dimmable)
I:	S: 500 mA M: 700 mA L: 500 mA
VOLTAGE:	220 - 240 V
LIFE TIME:	35.000 h
LUMEN MAINTENANCE:	L80_B10: 35000 h
CRI:	>90
MACADAM:	<3
UGR:	20

CE 



Let's get brighter

KIERA

FAMILY

ELECTRICAL DETAILS

POWER	S	M	L
WATTS:	4,5 W	7 W	18 W
EFFICIENCY			
EFF 2700K:	78 lm/w	81 lm/w	70 lm/w
EFF 3000K:	79 lm/w	82 lm/w	83 lm/w
EFF 4000K:	82 lm/w	85 lm/w	96 lm/w
LUMENS			
2700K lm:	411 lm	572 lm	1396 lm
3000K lm:	447 lm	574 lm	1655 lm
4000K lm:	488 lm	594 lm	1962 lm

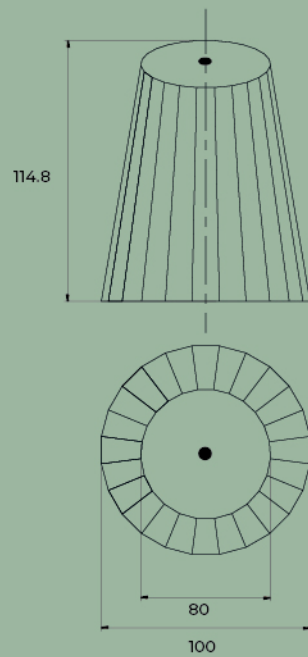

20204 L

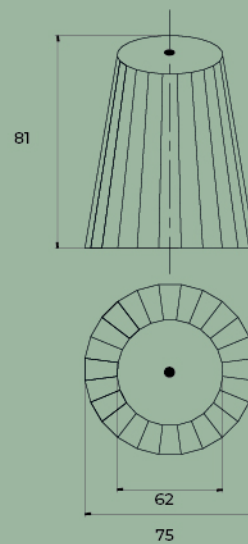

20204 M

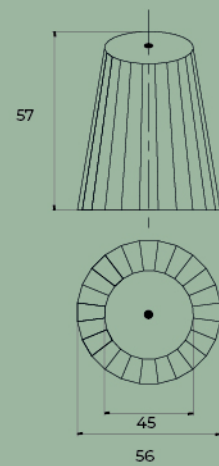

20204 S



KIERA

FAMILY

 **BPM**Lighting®

Let's get brighter



ALBERTA

due



Let's get brighter

CE 



Let's get brighter



MEASURES

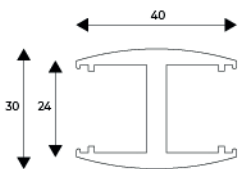
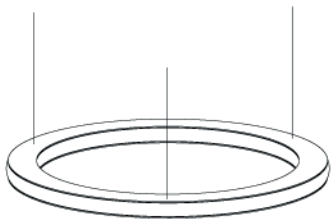

ALBERTA

due

GENERAL DETAILS

REFERENCE:	10250
INSTALLATION:	Pendant
EXTERNAL FINISH:	White · Black · Anodized grey · Gold · Blue · Aqua · Red · Flamingo · Green · Orange · Pink · Copper · Gold leaf · Silver leaf
MATERIAL:	Aluminium
IP DEGREE:	IP40
IK:	IK06
FORM:	Round
LIGHT DIRECTION:	Fixed
REGULATION:	1..10V · Push · DALI
OPTIC COVER:	Silicone
UTILIZATION:	Indoor
WARRANTY:	5 years

GENERAL DIMENSIONS

HEIGHT:	30 mm
EXT. DIAMETER:	Ø 350 450 650 950 1250 mm
MAXIMUM CABLE LENGTH	3000 mm
MINIMUM DISTANCE TO ILLUMINATED OBJECT:	0.5 m

ELECTRICAL DETAILS

LAMP:	LED
LED TYPE:	STRIPE LED
PROTECTION CLASS:	
ENERGETIC EFFICIENCY:	A+
DRIVER:	Included Remote
PF:	0.9
CONSTANT VOLTAGE:	24 V
VOLTAGE:	230 V
LIFE TIME:	35.000 h
LUMEN MAINTENANCE:	L80_B10 / 35000 h
CRI:	≥ 80
MACADAM:	3

CE 



Let's get brighter

ALBERTA

due

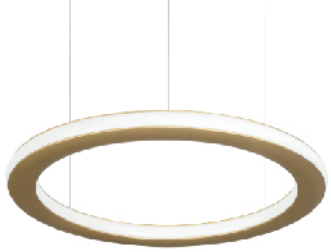

MEASURES

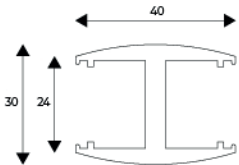
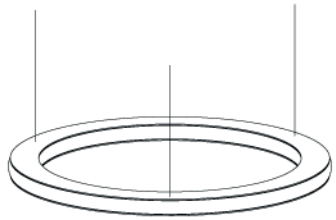

ELECTRICAL DETAILS

POWER	Ø 350	Ø 450	Ø 650	Ø 950	Ø 1250
	HI	HI	HI	HI	HI
WATTS:	28	37	56	83	110
EFFICIENCY					
EFF 2700K:	120 lm/w	120 lm/w	120 lm/w	120 lm/w	120 lm/w
EFF 3000K:	121 lm/w	121 lm/w	121 lm/w	121 lm/w	121 lm/w
EFF 4000K:	129 lm/w	129 lm/w	129 lm/w	129 lm/w	129 lm/w
INTERNAL LUMENS					
2700K lm:	3419 lm	4507 lm	6685 lm	9951 lm	13108 lm
3000K lm:	3436 lm	4531 lm	6720 lm	10003 lm	13177 lm
4000K lm:	3661 lm	4828 lm	7160 lm	10658 lm	14040 lm
EXTERNAL LUMENS					
2700K lm:	3419 lm	4507 lm	6685 lm	9951 lm	13108 lm
3000K lm:	3436 lm	4531 lm	6720 lm	10003 lm	13177 lm
4000K lm:	3661 lm	4828 lm	7160 lm	10658 lm	14040 lm

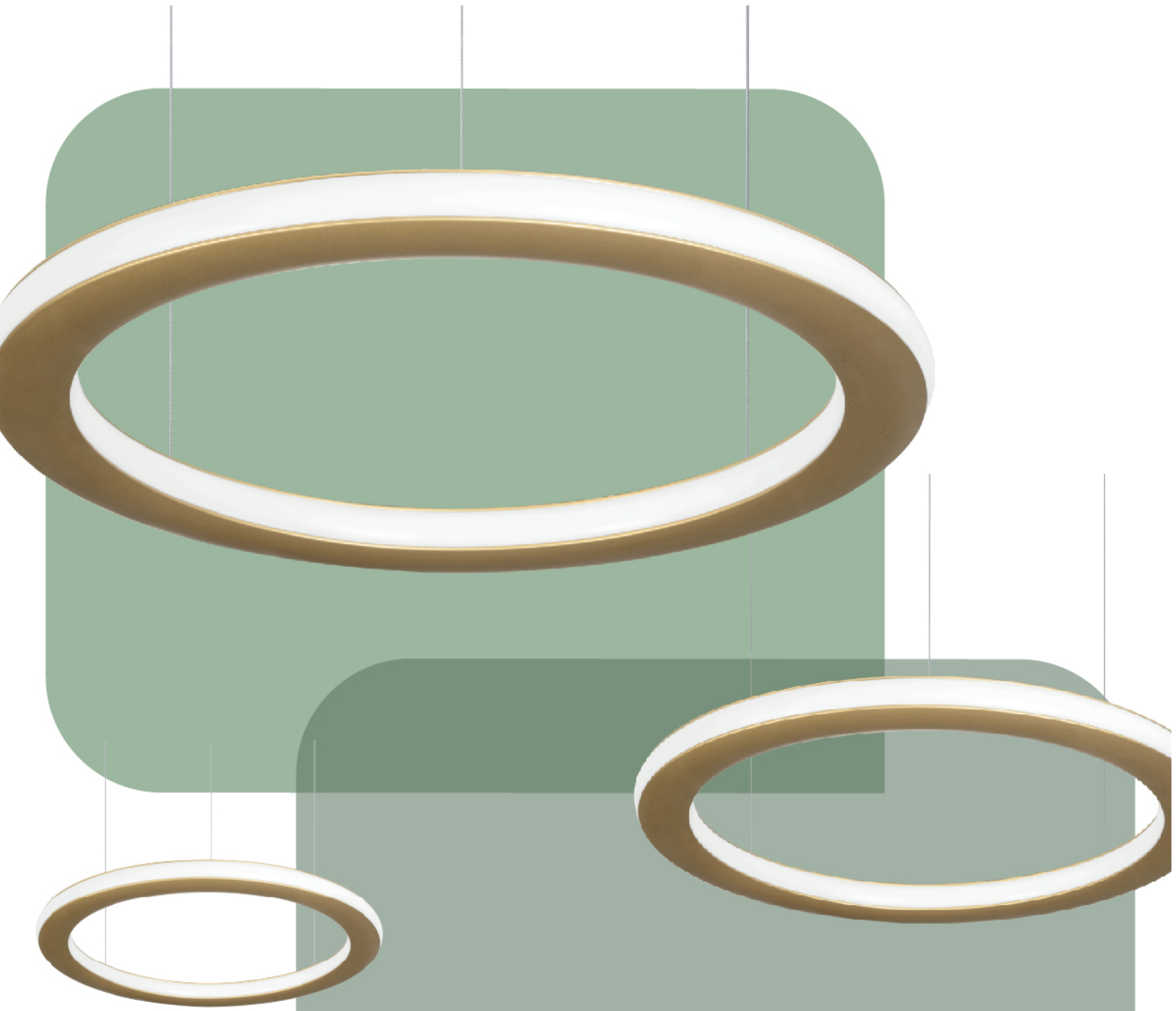

ALBERTA
due

 **BPM**Lighting®

Let's get brighter



ALBERTA
inside



Let's get brighter

CE 



Let's get brighter



MEASURES

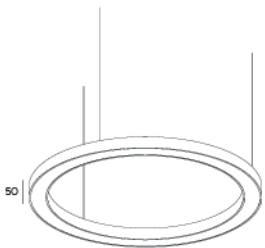

ALBERTA

inside

GENERAL DETAILS

REFERENCE: 10243
INSTALLATION: Pendant
EXTERNAL FINISH: White · Black · Anodized grey · Gold · Blue · Aqua · Red · Flamingo · Green · Orange · Pink · Copper · Gold leaf · Silver leaf

MATERIAL: Aluminium
IP DEGREE: IP40
IK: IK06
FORM: Round

LIGHT DIRECTION: Fixed
REGULATION: 1..10V · Push · DALI
OPTIC COVER: Silicone
UTILIZATION: Indoor
WARRANTY: 5 years

GENERAL DIMENSIONS

HEIGHT: 50 mm
EXT. DIAMETER: Ø 350 | 450 | 650 | 950 | 1250 mm
MAXIMUM CABLE LENGTH: 3000 mm
MINIMUM DISTANCE TO ILLUMINATED OBJECT: 0.5 m

ELECTRICAL DETAILS

LAMP: LED
LED TYPE: STRIPE LED
PROTECTION CLASS: 
ENERGETIC EFFICIENCY: A+
DRIVER: Included Remote
PF: 0.9
CONSTANT VOLTAGE: 24 V
VOLTAGE: 230 V
LIFE TIME: 35.000 h
LUMEN MAINTENANCE: L80_B10 / 35000 h
CRI: ≥80
MACADAM: 3

CE 



Let's get brighter

ALBERTA

inside

ELECTRICAL DETAILS

POWER	Ø 350		Ø 450		Ø 650		Ø 950		Ø 1250	
		HI		HI		HI		HI		HI
WATTS:		27		36		54		81		109
EFFICIENCY										
EFF 2700K:		120 lm/w		120 lm/w		120 lm/w		120 lm/w		120 lm/w
EFF 3000K:		121 lm/w		121 lm/w		121 lm/w		121 lm/w		121 lm/w
EFF 4000K:		129 lm/w		129 lm/w		129 lm/w		129 lm/w		129 lm/w
LUMENS										
2700K lm:		3266 lm		4355 lm		6532 lm		9798 lm		13065 lm
3000K lm:		3283 lm		4378 lm		6567 lm		9850 lm		13133 lm
4000K lm:		3498 lm		4664 lm		6996 lm		10495 lm		13993 lm

MEASURES

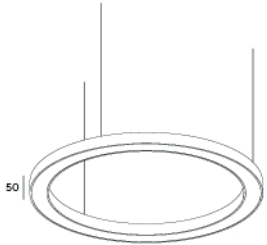

ALBERTA

INSIDE

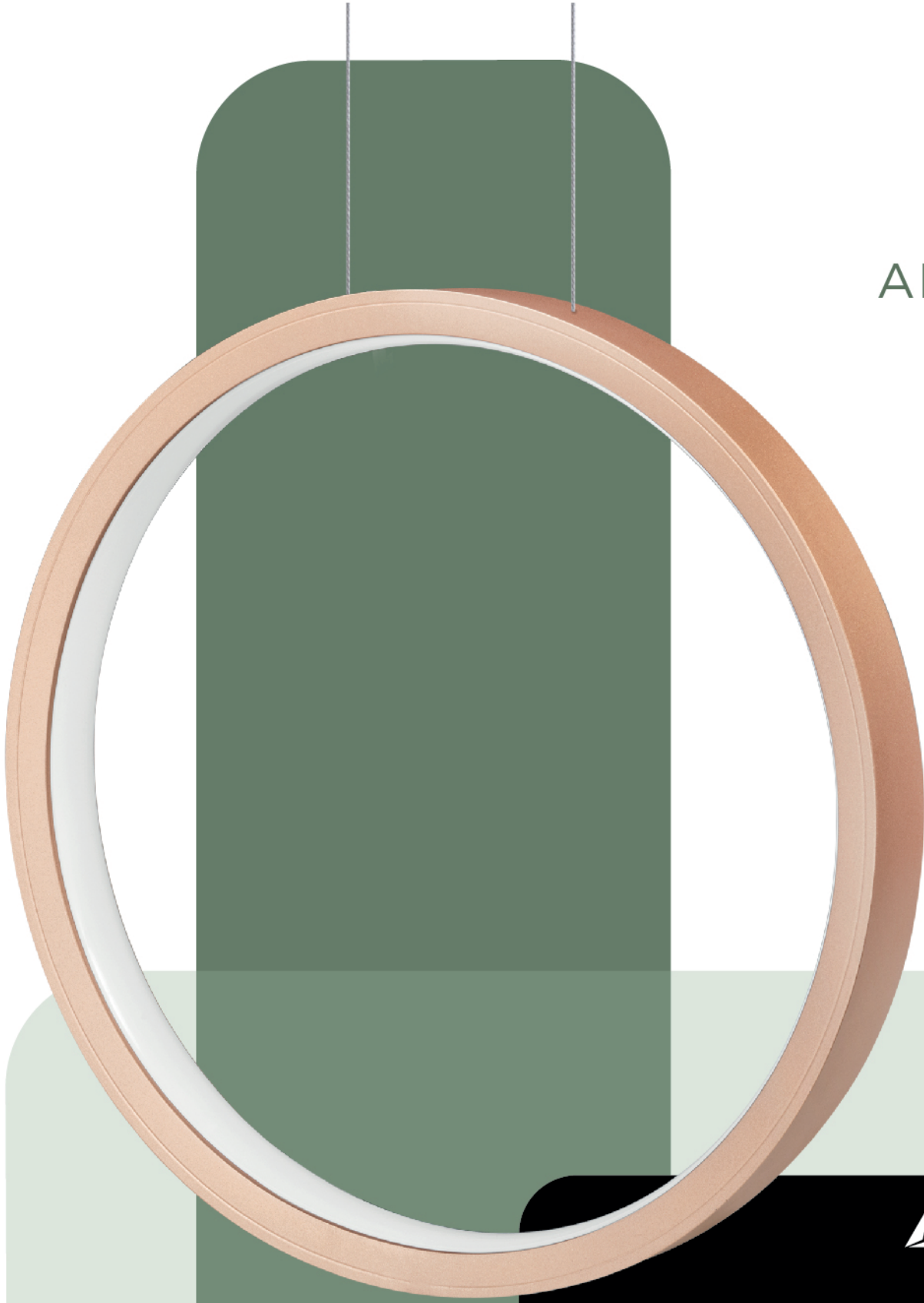

Let's get brighter



GALANTA

EXALTS THE BEAUTY

 **BPM**Lighting®

Let's get brighter



Let's get brighter

GALANTA

EXALTS THE BEAUTY



GENERAL DETAILS

REFERENCE:	20221
INSTALLATION:	Pendant
EXTERNAL FINISH:	.BK Black .W White .SG Shiny Gold .CH Chrome
MATERIAL:	Iron and Methacrylate
IP EXTERIOR:	IP20
FORM:	Round
IK:	IK06
LIGHT DIRECTION:	Fixed
REGULATION:	Non-dimm
UTILIZATION:	Indoor
WARRANTY:	5 years

GENERAL DIMENSIONS

	60.5 X 60.5 X 200 mm.
MAXIMUM CABLE LENGTH	3000 mm
MINIMUM DISTANCE TO ILLUMINATED OBJECT:	0.5 m

ELECTRICAL DETAILS

LAMP:	G9 LED
LAMP HOLDER:	G9
PROTECTION CLASS:	⊕
ENERGETIC EFFICIENCY:	A+
VOLTAGE:	220 - 240 V
LIFE TIME:	30.000 h
CRI:	90
POWER:	5 W

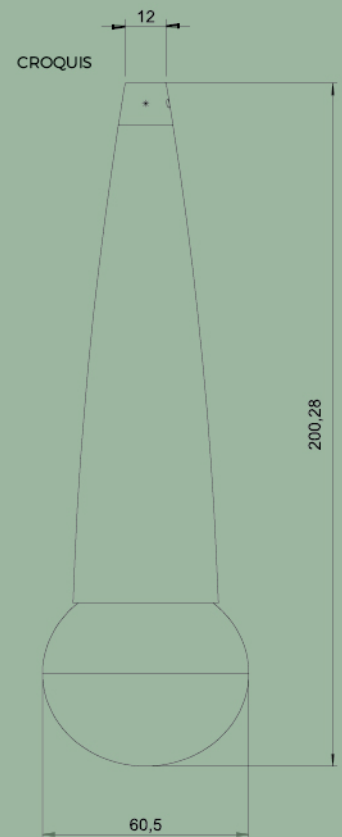



20206.03

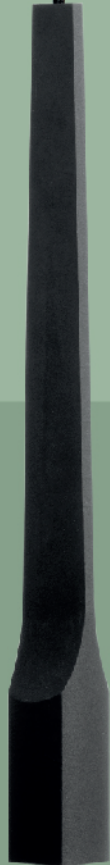

20206.04



20206.10

SUBLIM

The Elegance of Geometry



Let's get brighter



Let's get brighter



SUBLIM

FAMILY

GENERAL DETAILS

REFERENCE:	20206.03 20206.04 20206.10
INSTALLATION:	Pendant
EXTERNAL FINISH:	White · Black
MATERIAL:	Aluminium
IP DEGREE:	IP20
FORM:	Round
IK:	IK07
LIGHT DIRECTION:	Fixed
REGULATION:	1..10V · Push · DALI · Phase Cut
BEAM ANGLE:	36°
UTILIZATION:	Indoor
WARRANTY:	5 years

GENERAL DIMENSIONS

	20206.03 : 39 X 39 X 270 mm.
	20206.04 : 39 X 39 X 400 mm.
	20206.10 : 39 X 39 X 1000 mm.
MAXIMUM CABLE LENGTH	3000 mm
MINIMUM DISTANCE TO ILLUMINATED OBJECT:	0.5 m

ELECTRICAL DETAILS

LAMP:	LED
LED TYPE:	BRIDGELUX
PROTECTION CLASS:	ⓘ
ENERGETIC EFFICIENCY:	A+
DRIVER:	Included (remote if dimmable)
I:	350 mA
VOLTAGE:	220 - 240 V
LIFE TIME:	50.000 h
LUMEN MAINTENANCE:	L80_B10 / 50000 h
CRI:	93
MACADAM:	<3
UGR:	<19



Let's get brighter

SUBLIM

FAMILY

ELECTRICAL DETAILS

POWER	
WATTS:	9 W
EFFICIENCY	
EFF 2700K:	62 lm/w
EFF 3000K:	62 lm/w
EFF 4000K:	68 lm/w
LUMENS	
2700K lm:	469 lm
3000K lm:	482 lm
4000K lm:	495.3 lm

MEASURES (mm.)

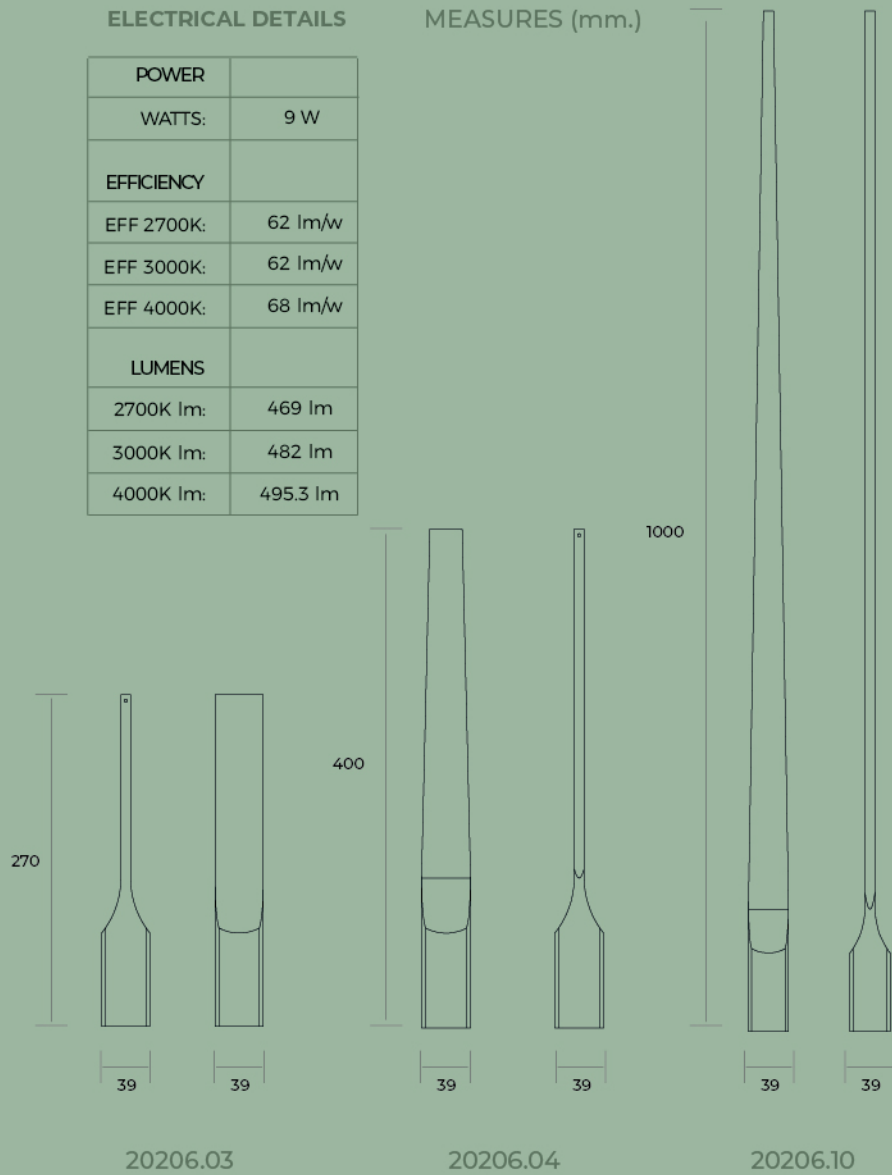

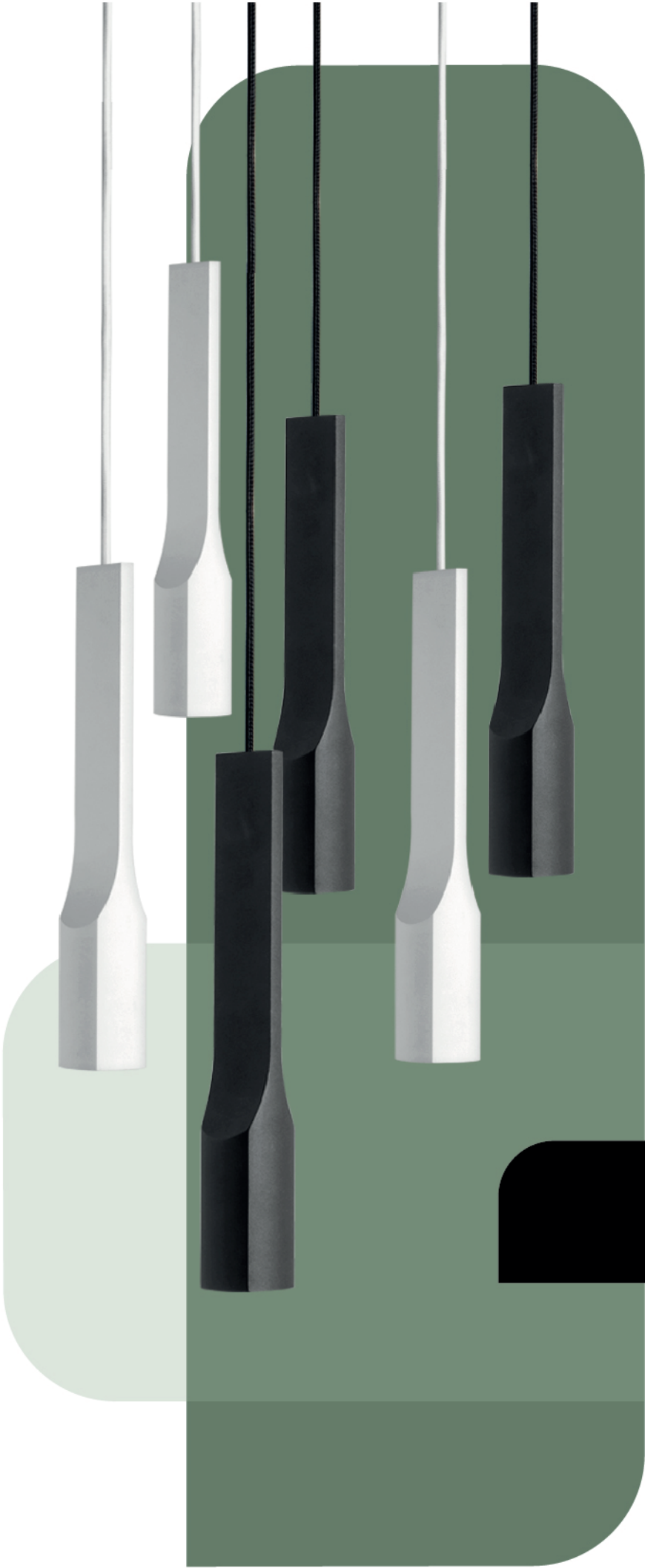

SUBLIM

 **BPM**Lighting®
Let's get brighter



KIERA CEM
SERENE AND ATEMPORAL

 **BPM**Lighting®

Let's get brighter

CE 

 **BPM**Lighting®

Let's get brighter



KIERA CEM

S | M | L

GENERAL DETAILS

REFERENCE:	20208 S M L
INSTALLATION:	Pendant
EXTERNAL FINISH:	Black
MATERIAL:	Aluminium and Cement
IP DEGREE:	IP20
FORM:	Round
IK:	IK06
LIGHT DIRECTION:	Fixed
REGULATION:	1..10V · Push · DALI · Non Dimm
BEAM ANGLE:	38°
UTILIZATION:	Indoor
WARRANTY:	5 years

GENERAL DIMENSIONS

	20208 S : Ø56 x 197 mm
	20208 M : Ø75 x 269mm
	20208 L : Ø100 x 342 mm
MAXIMUM CABLE LENGTH	3000 mm
MINIMUM DISTANCE TO ILLUMINATED OBJECT:	0.5 m

ELECTRICAL DETAILS

LAMP:	LED
PROTECTION CLASS:	
ENERGETIC EFFICIENCY:	A++
DRIVER:	Included (remote if dimmable)
I:	S: 500 mA M: 700 mA L: 500 mA
VOLTAGE:	220 - 240 V
LIFE TIME:	35.000 h
LUMEN MAINTENANCE:	L80_B10: 35000 h
CRI:	>90
MACADAM:	<3
UGR:	20

CE 

 **BPM**Lighting®

Let's get brighter



KIERA CEM

S | M | L

ELECTRICAL DETAILS

POWER	S	M	L
WATTS:	4,5 W	7 W	18 W
EFFICIENCY			
EFF 2700K:	78 lm/w	81 lm/w	70 lm/w
EFF 3000K:	79 lm/w	82 lm/w	83 lm/w
EFF 4000K:	82 lm/w	85 lm/w	96 lm/w
LUMENS			
2700K lm:	411 lm	572 lm	1396 lm
3000K lm:	447 lm	574 lm	1655 lm
4000K lm:	488 lm	594 lm	1962 lm

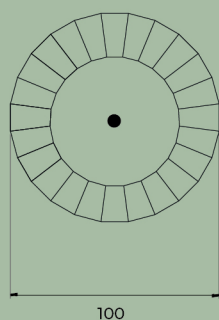
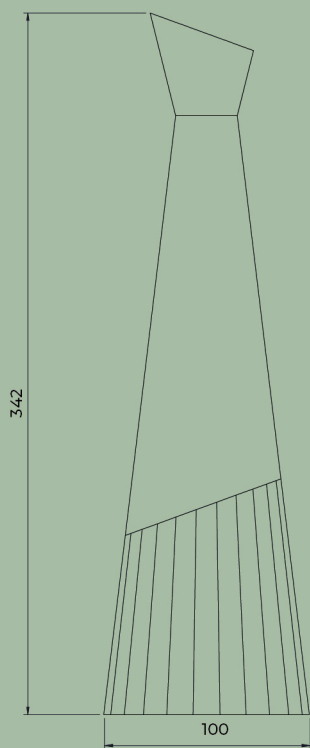

20208 L

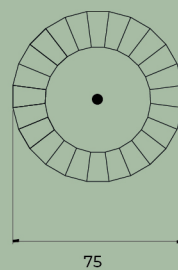
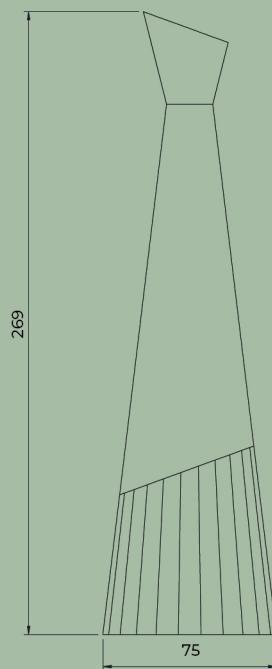

20208 M

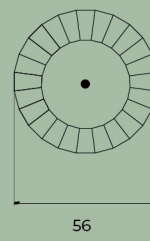
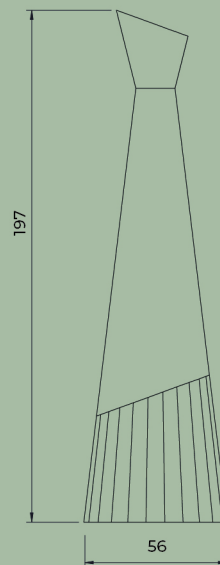

20208 S



IRIS
Beyond the Light

 **BPM**Lighting®

Let's get brighter

CE 



Let's get brighter



IRIS

Beyond the light

GENERAL DETAILS

REFERENCE:	20203 S M L
INSTALLATION:	Pendant
EXTERNAL FINISH:	White · Black
MATERIAL:	Aluminium
IP DEGREE:	IP20
FORM:	Round
IK:	IK06
LIGHT DIRECTION:	Fixed
REGULATION:	1..10V · Push · DALI · Non Dimm
BEAM ANGLE:	38°
UTILIZATION:	Indoor
WARRANTY:	5 years

GENERAL DIMENSIONS

	20203 S : Ø105 mm
	20203 M : Ø170 mm
	20203 L : Ø265 mm
MAXIMUM CABLE LENGTH	3000 mm
MINIMUM DISTANCE TO ILLUMINATED OBJECT:	0.5 m

ELECTRICAL DETAILS

LAMP:	Bridgelux
PROTECTION CLASS:	
ENERGETIC EFFICIENCY:	A
DRIVER:	Included (remote if dimmable)
I:	S: 500 mA M: 500 mA L: 700 mA
VOLTAGE:	220 - 240 V
LIFE TIME:	50.000 h
LUMEN MAINTENANCE:	L80_B10: 50000 h
CRI:	>90
MACADAM:	3

CE 



Let's get brighter



IRIS

Beyond the light

ELECTRICAL DETAILS

POWER	S	M	L
WATTS:	10	18	25
EFFICIENCY			
EFF 2700K:	70 lm/w	74 lm/w	76 lm/w
EFF 3000K:	73 lm/w	82 lm/w	85 lm/w
EFF 4000K:	78 lm/w	86 lm/w	88 lm/w
LUMENS			
2700K lm:	770 lm	1490 lm	2191 lm
3000K lm:	802 lm	1674 lm	2454 lm
4000K lm:	850 lm	1754 lm	2542 lm

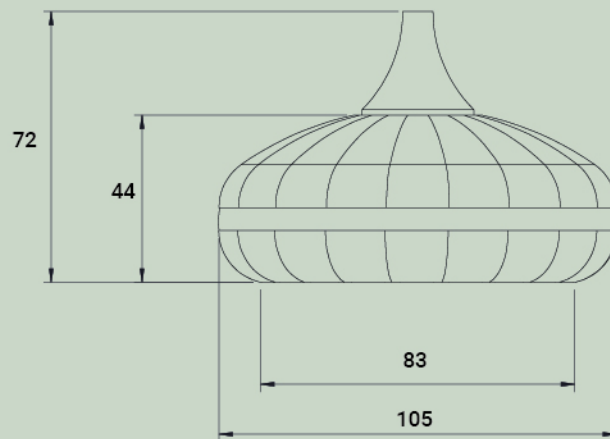

CE 

 **BPM**Lighting®

Let's get brighter



IRIS

Beyond the light

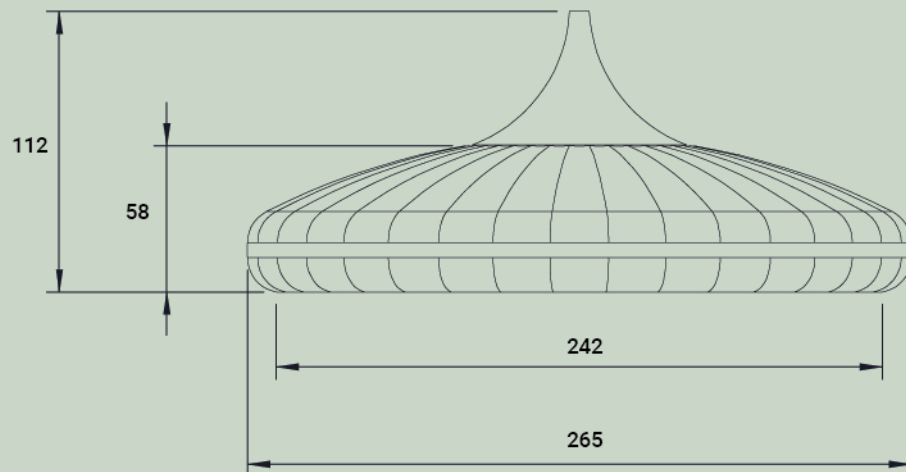
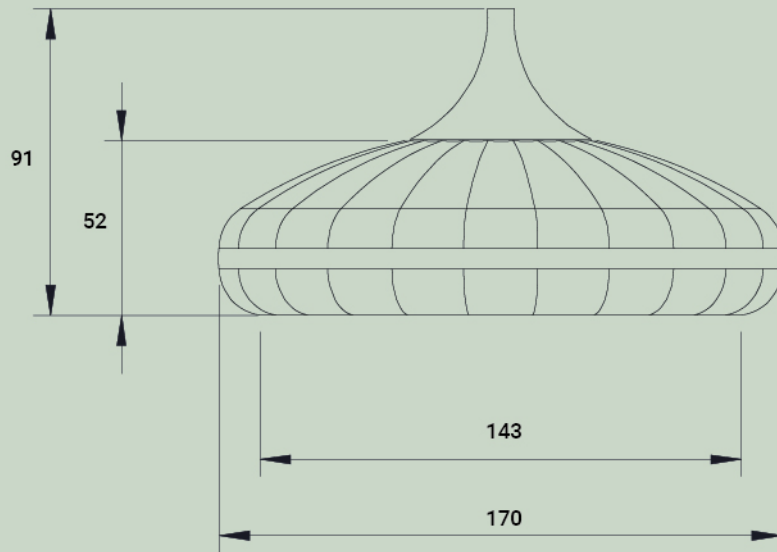



FACE
The Contemporary Classic



Let's get brighter

CE 



Let's get brighter



FACE

The Contemporary Classic

GENERAL DETAILS

REFERENCE:	20205.30.PN 20205.40.PN 20207.30.PN 20207.40.PN 20205.10.SR 20205.10.RF
INSTALLATION:	Pendant Surface Recessed with Frame
EXTERNAL FINISH:	White · Black
MATERIAL:	Aluminium
IP DEGREE:	IP20
FORM:	Round
IK:	IK06
LIGHT DIRECTION:	Fixed
REGULATION:	1..10V · Push · DALI · Non Dimm
BEAM ANGLE:	38°
UTILIZATION:	Indoor
WARRANTY:	5 years

GENERAL DIMENSIONS

	20205.30.PN: Ø40X300 20205.40.PN: Ø40X400 20207.30.PN: Ø60X300 20205.40.PN: Ø60X400 20205.10.SR: Ø40X140 20205.10.RF: Ø40X122
MAXIMUM CABLE LENGTH	3000 mm
MINIMUM DISTANCE TO ILLUMINATED OBJECT:	0.5 m

ELECTRICAL DETAILS

LAMP:	Bridgelux
PROTECTION CLASS:	
ENERGETIC EFFICIENCY:	A
DRIVER:	Included (remote if dimmable) - * always remote
I:	20205.30.PN: 500mA 20205.40.PN: 500mA 20207.30.PN: 700mA 20205.40.PN: 700mA *20205.10.SR: 350mA *20205.10.RF: 350mA
VOLTAGE:	220 - 240 V
LIFE TIME:	50.000 h
LUMEN MAINTENANCE:	L80_B10: 50.000 h
CRI:	>90
MACADAM:	20205.30.PN: 4 20205.40.PN: 4 20207.30.PN: 3 20205.40.PN: 3 20205.10.SR: 3 20205.10.RF: 3

CE 



Let's get brighter

FACE

The Contemporary Classic

ELECTRICAL DETAILS

POWER	20205.30.PN	20205.40.PN	20207.30.PN	20207.40.PN	20205.10.SR	20205.10.RF
WATTS:	12	12	18	18	8	8
EFFICIENCY						
EFF 2700K:	54 lm/w	54 lm/w	66 lm/w	66 lm/w	62 lm/w	62 lm/w
EFF 3000K:	54 lm/w	54 lm/w	68 lm/w	68 lm/w	62 lm/w	62 lm/w
EFF 4000K:	55 lm/w	55 lm/w	70 lm/w	70 lm/w	68 lm/w	68 lm/w
LUMENS						
2700K lm:	587 lm	587 lm	1056 lm	1056 lm	469 lm	469 lm
3000K lm:	588 lm	588 lm	1078 lm	1078 lm	482 lm	482 lm
4000K lm:	597 lm	597 lm	1099 lm	1099 lm	495 lm	495 lm



20205.30



20205.40



CE 

 **BPM**Lighting®

Let's get brighter

FACE

The Contemporary Classic

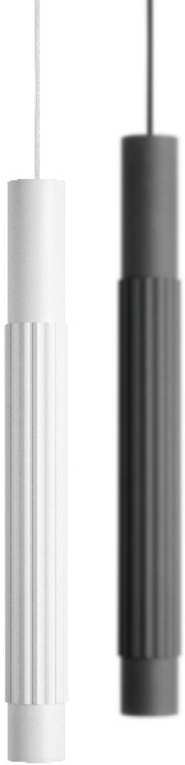

300

Ø60

20207.30



400

Ø60

20207.40

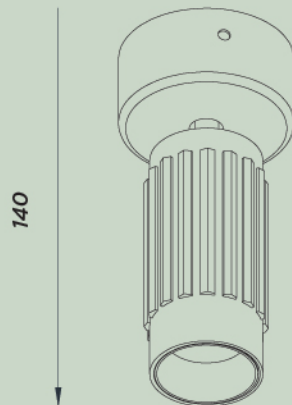

140

Ø40

20205.SR

92

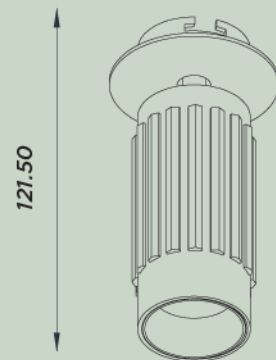

121.50

Ø40

20205.RF

92



 **BPM**Lighting®

Let's get brighter

Let's play

Versatility. Adding or removing magnetic accessories to achieve the desired atmosphere. Playing with light has never been so simple.



Let's get brighter