

Arrangements

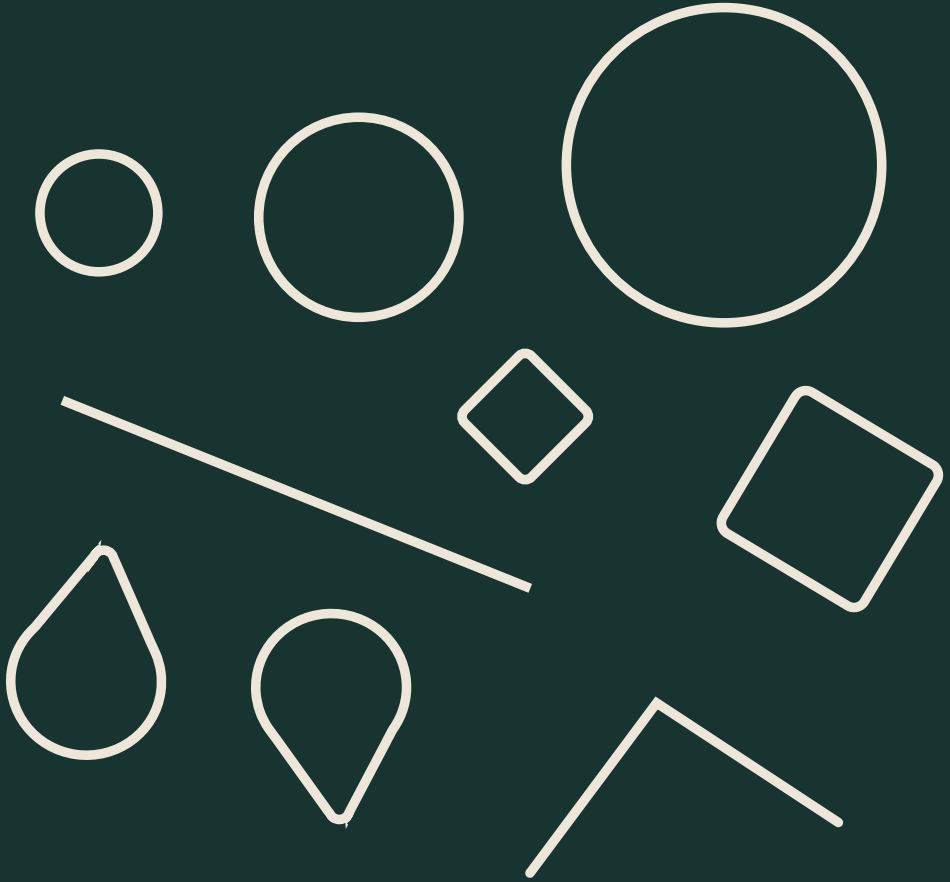

Michael Anastassiades

FLOS

KELMAX

veľlo inak...

Rastislav Sabo - KELMAX

Košovská cesta 24
971 01 Prievidza

e-mail: kelmax@kelmax.sk

www.kelmax.sk

tel.: +421 944 919 288

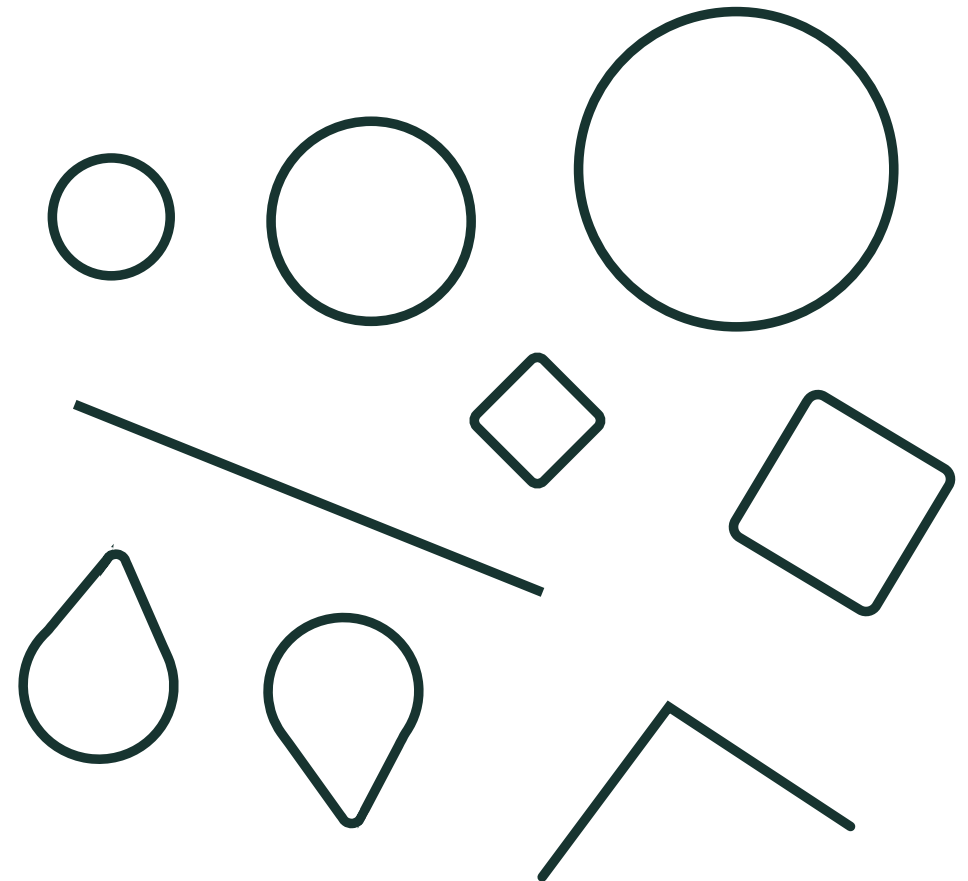

Michael Anastassiades

‘I have always been fascinated with the parallel that exists between Lighting and Jewelry. Starting from the simple fact of how each piece relates to the human scale: one is designed to be worn on the body whereas the other is made to decorate the space someone occupies. I’m challenged in how the delicate nature of something small can be translated spatially and still manage to retain its preciousness in the way materials are presented. It is no coincidence that the word ‘pendant’ has a double meaning. Existing both as a piece of jewelry that hangs from a chain worn round the neck, and a light designed to hang from the ceiling. Arrangements is a modular system of geometric light elements that can be combined in different ways, creating multiple compositions into individual chandeliers. Each unit simply attaches onto the previous one as if resting, balancing perfectly as part of a glowing chain’.

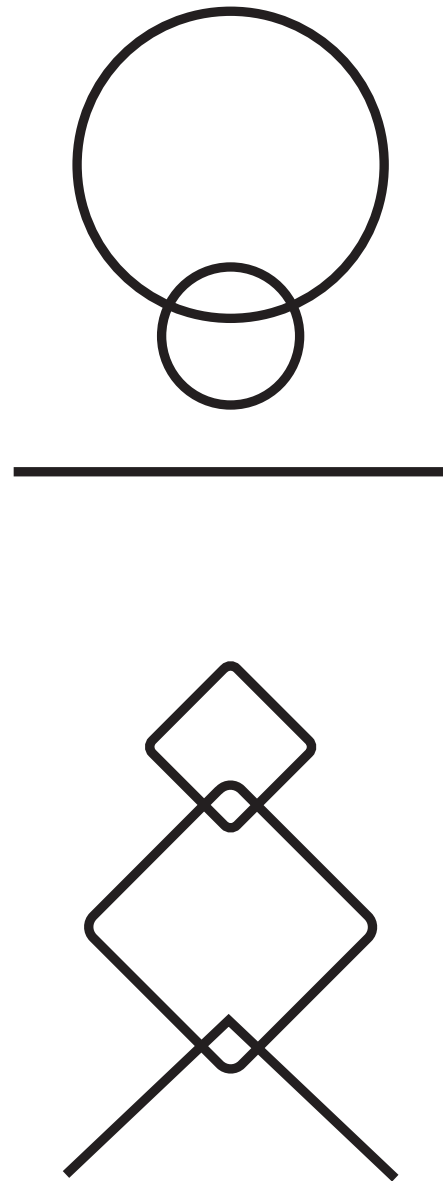
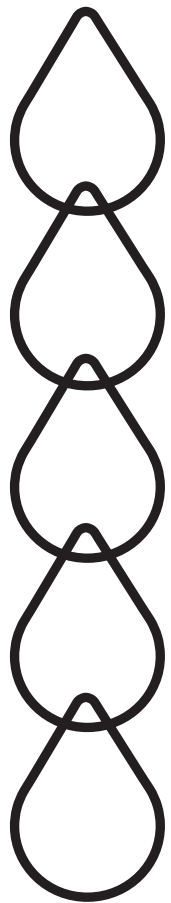



Michael Anastassiades

IT “Mi ha sempre affascinato il parallelismo che esiste tra gli oggetti di luce e i gioielli. Partendo dal semplice fatto che entrambi sono legati alla sfera umana: disegnati per essere indossati gli uni, per decorare gli spazi abitati gli altri. La mia sfida è capire come la natura delicata di qualcosa di piccolo possa essere traslata nello spazio e mantenere la sua preziosità grazie al modo in cui i materiali vengono presentati. Non è un caso che il termine ‘pendant’ in inglese abbia un doppio significato. Si usa sia per definire un gioiello o pendente di una collana, che per una luce appesa al soffitto. Arrangements è un sistema modulare di elementi geometrici di luce che si possono combinare in modo diverso per creare composizioni multiple di singoli chandelier. Ogni modulo si fissa al precedente in modo semplice, adagiato in perfetto equilibrio, come un elemento di una catena luminosa.” Michael Anastassiades

FR “J’ai toujours été fasciné par le parallèle qui existe entre la lumière et les bijoux, par le simple fait que les deux sont en relation avec l’humain : l’une est destinée à être portée sur le corps tandis que l’autre sert à décorer l’espace habité. Je me suis mis au défi de voir comment la nature délicate d’une chose petite peut être transposée dans l’espace tout en conservant son caractère précieux grâce à la manière dont sont présentés les matériaux qui la composent. Ce n’est pas une coïncidence si le mot “pendant” (pendentif en anglais) a une double signification. Il est utilisé pour désigner un bijou suspendu à une chaîne portée autour du cou mais aussi pour une lampe conçue pour être suspendue au plafond. Arrangements est un système modulaire d’éléments géométriques lumineux pouvant être associés de différentes façons pour créer de multiples compositions de lustres. Chaque module se fixe simplement sur le précédent, comme s’il reposait en parfait équilibre comme un élément d’une chaîne.” Michael Anastassiades

Arrangements

SP «Siempre me ha fascinado el paralelismo que existe entre la iluminación y las joyas. Partiendo del simple hecho de que ambos están unidos a la esfera humana: una diseñada para decorar los espacios habitados y las otras para embellecernos . El desafío al que me enfrento es entender cómo la naturaleza delicada de algo pequeño se puede trasladar al espacio y mantener su encanto gracias al modo en el que los materiales se presentan. No es coincidencia que el término ‘pendant’ tenga doble significado en inglés. Se utiliza para definir una joya o colgante de un collar y también para referirse a una luminaria diseñada para colgarse del techo. Arrangements es un sistema modular de elementos geométricos de luces que se pueden combinar de distinta forma para crear composiciones múltiples de “chandeliers” individuales. Cada módulo se fija al anterior de manera sencilla, como si estuviese descansando en un equilibrio perfecto, como un elemento de una cadena luminosa.» Michael Anastassiades

DE „Ich war immer vom Parallelismus fasziniert, der zwischen den Lichtobjekten und den Schmuckstücken besteht. Schon alleine aufgrund die Tatsache, dass beide mit der menschlichen Sphäre verbunden sind: die einen entworfen, um getragen zu werden, die anderen, um die Wohnräume zu schmücken. Meine Herausforderung ist es, zu verstehen, wie die zarte Natur von etwas Kleinem in den Raum übertragen werden kann und gleichzeitig seine Kostbarkeit, dank der Art, wie die Materialien präsentiert werden, bewahrt wird. Nicht zufällig hat der englische Begriff „Pendant“ eine doppelte Bedeutung. Er wird nicht nur verwendet, um ein Schmuckstück oder einen Anhänger einer Kette zu definieren, sondern auch ein Licht, das entworfen wurde, um von der Decke zu hängen. Arrangements ist ein modulares System aus geometrischen Beleuchtungselementen, die unterschiedlich kombiniert werden können, um zahlreiche Kompositionen einzelner Leuchten zu schaffen. Jedes Modul kann auf einfache Weise ans vorhergehende Teil angebracht werden, in perfektem Gleichgewicht eingebettet, wie ein Element einer Lichterkette.“ Michael Anastassiades

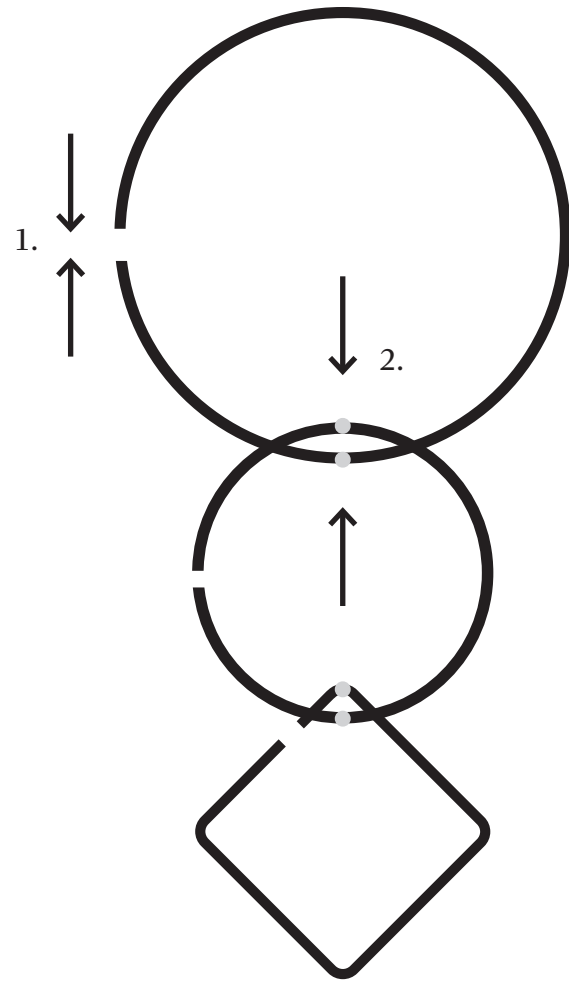

1. Click to close
2. Click to join







12



13







18



19

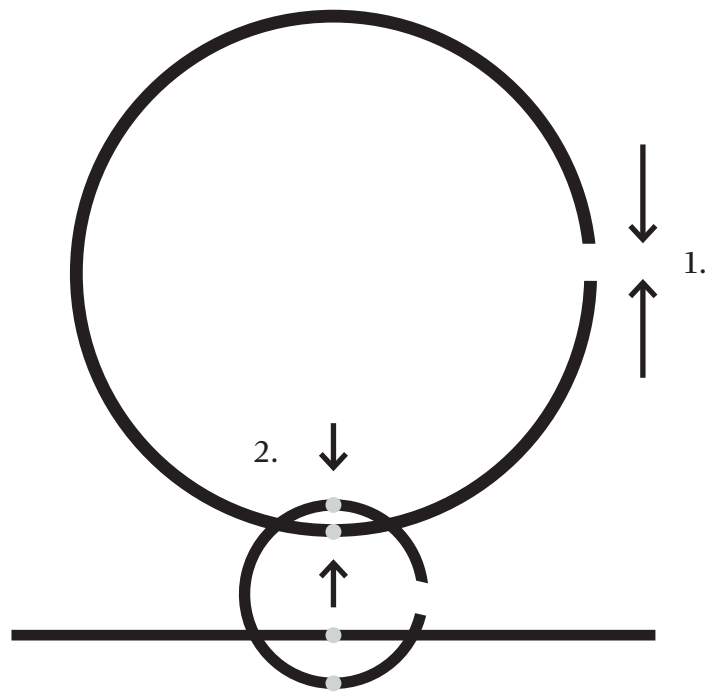

1. Click to close
2. Click to join



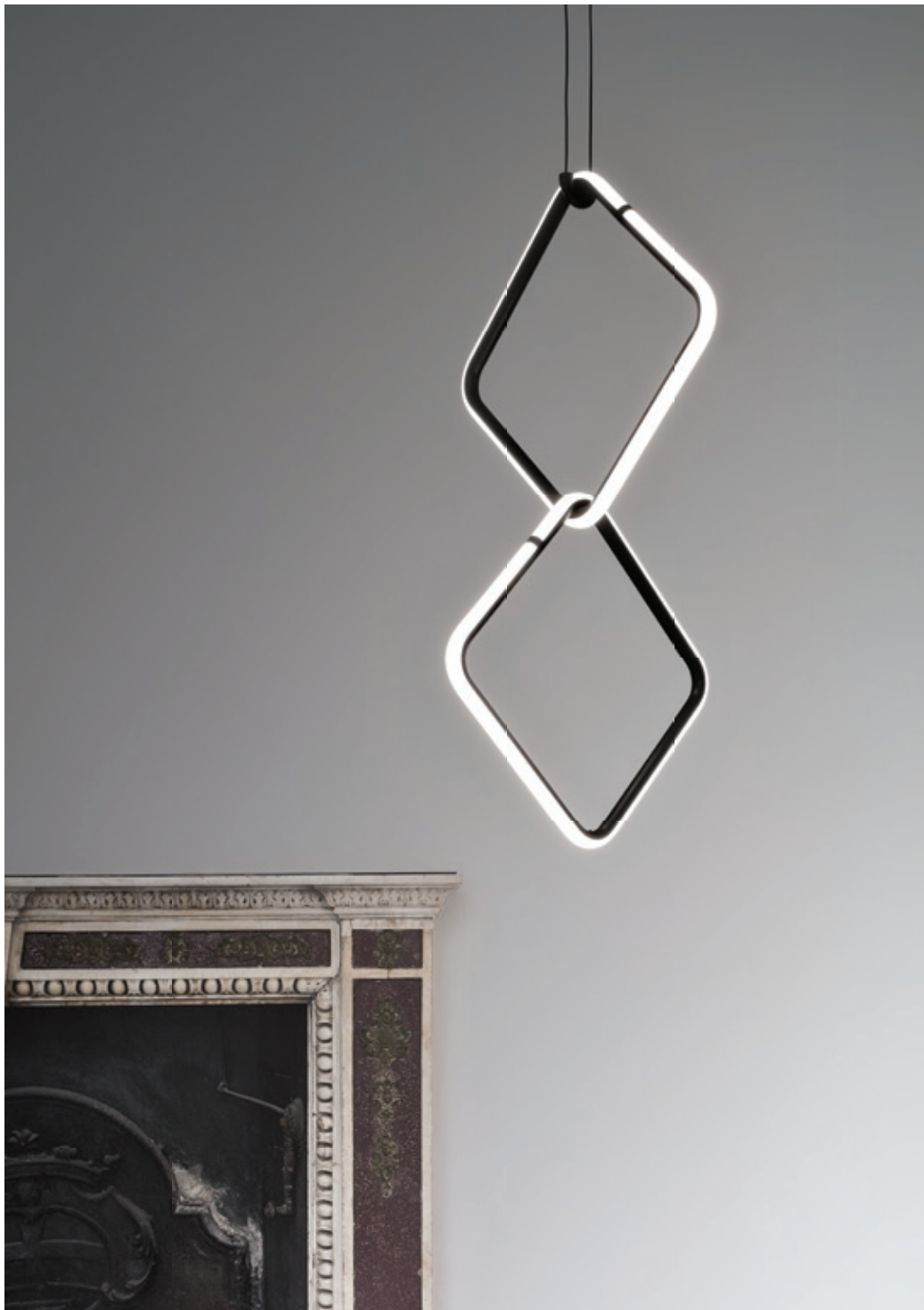

22



23





26



27



28

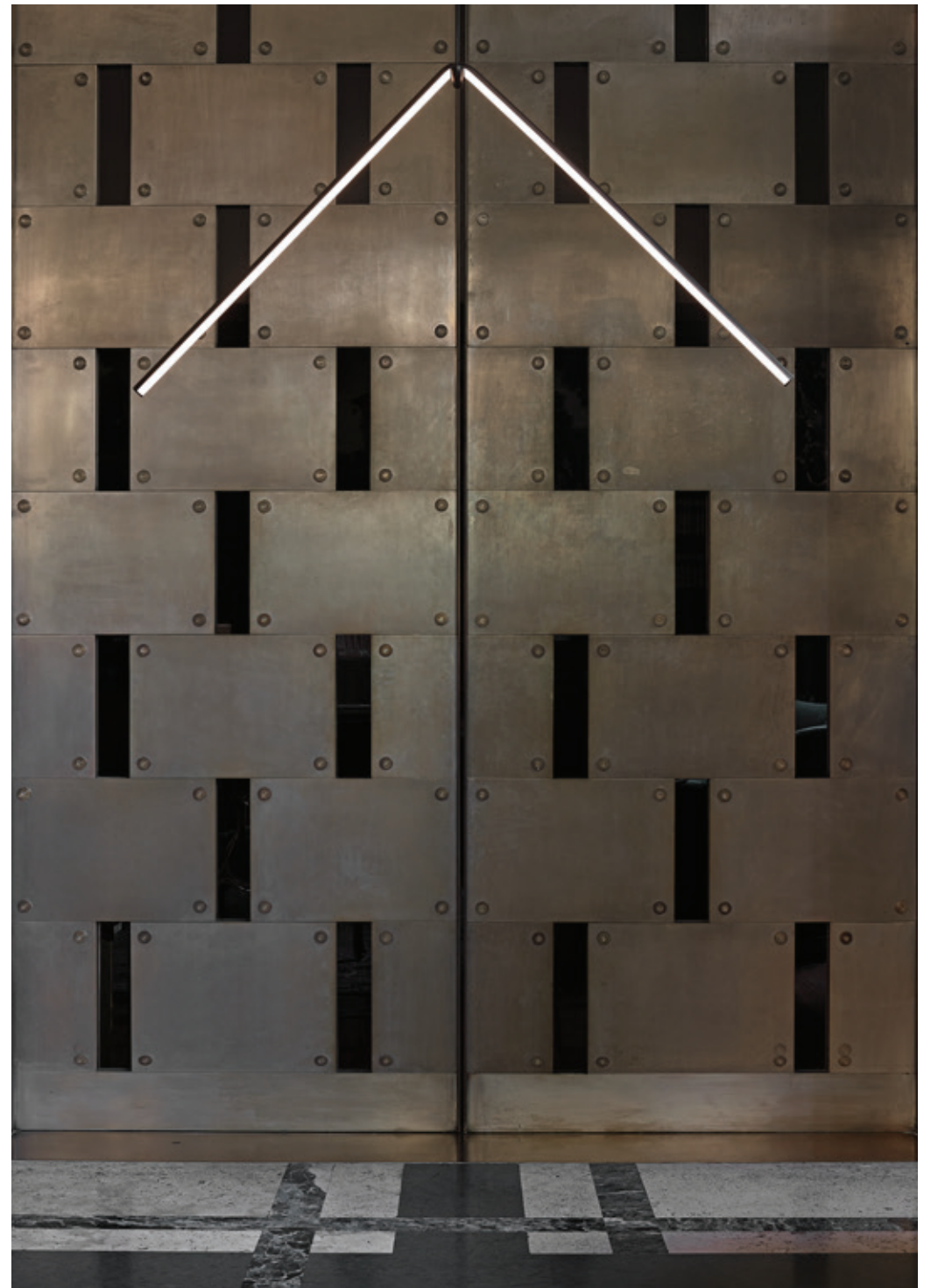

29





32



33





36

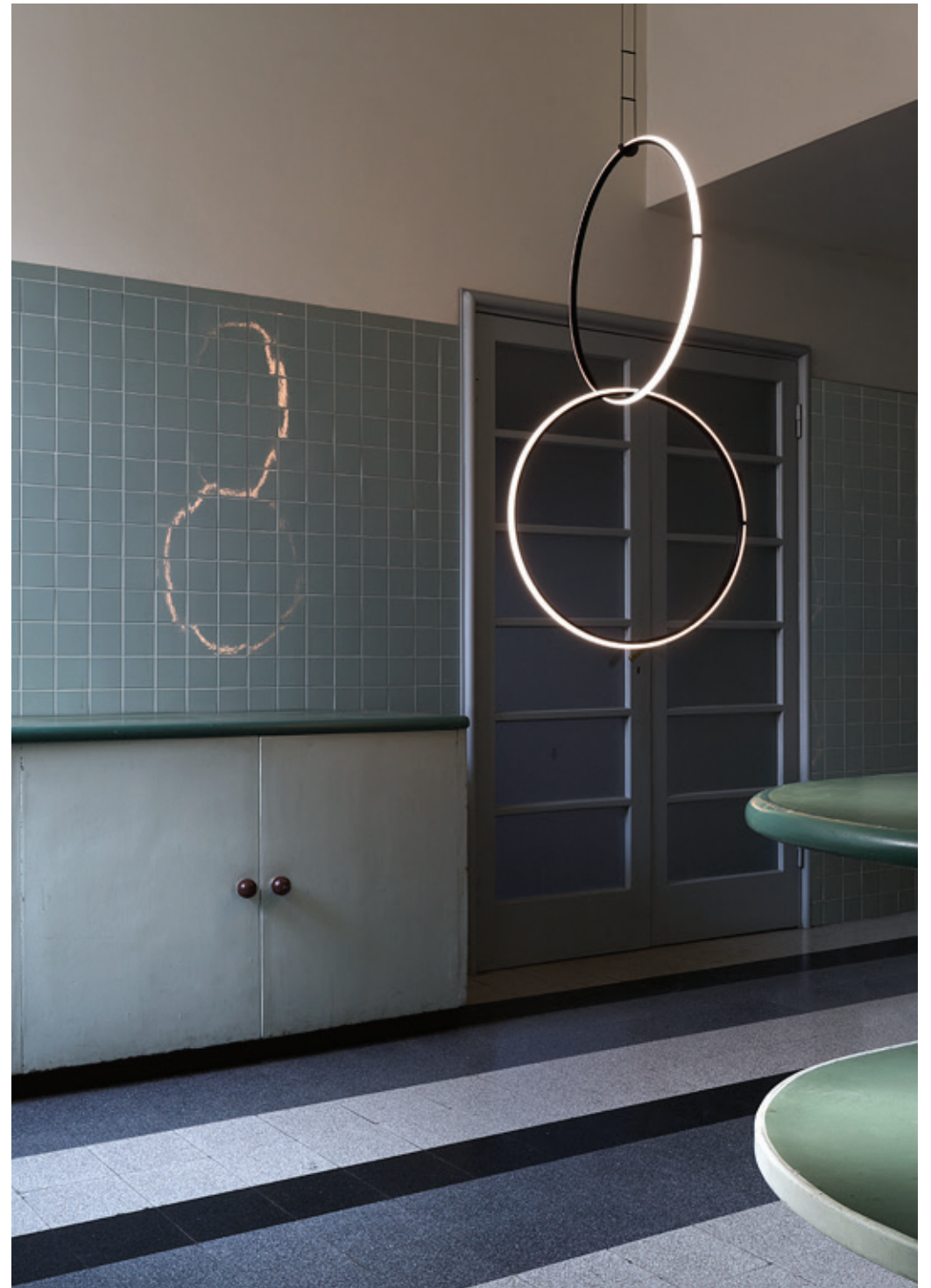

37







Arrangements technical description

Diffuse light suspended lighting device. Body in extruded, curved NC-machined and black powder-coated aluminium, diffuser in platinum optical silicone. Each component can be connected to the power pack by means of an electrical and mechanical connection system designed for customisable product set-up.

Roses are available in two power options: lamp with power under 70W and lamp with power under 190W. Class III roses are also available for installations with remote power supply: “surface” version for installations on cement, “recessed” version for plasterboard ceilings. The electronics integrated in the rose enable the use of the following dimming systems: push, 1-10, potentiometer, DALI. In the absence of these systems, the light flow can be set with the push system included in the rose.

CABLE LENGTH: 2.5M (98.43”) – MATERIAL: ALUMINIUM – FINISH: BLACK

IT Apparecchio d'illuminazione a sospensione, a luce diffusa. Corpo in alluminio estruso, curvato, lavorato a CN e verniciato nero a polvere, diffusore in silicone ottico platinico. Ogni elemento è alimentato grazie a un sistema di connessione elettrica e meccanica, studiato appositamente per consentire configurazioni personalizzate del prodotto.

I rosoni sono disponibili in due potenze: per una configurazione della lampada con potenza inferiore a 70W, o inferiore a 190W. Sono disponibili anche rosoni classe III per installazioni con power supply remoto: in versione "surface" nel caso di installazione su cemento, o "recessed" per soffitti in cartongesso.

L'elettronica integrata nel rosone consente l'utilizzo di diversi sistemi di dimerizzazione: push, 1-10, potenziometro, DALI. Nel caso di assenza di questi sistemi si può settare il flusso luminoso in fase di installazione, con sistema push incluso nel rosone.

LUNGHEZZA DEI CAVI: 2,5MT (98.43")
MATERIALE: ALLUMINIO
FINITURA: NERO

FR Suspension à lumière diffuse. Corps en aluminium extrudé, courbé, travaillé en CN et recouvert de peinture poudre noire, diffuseur en silicone optique platinique. Chaque élément peut être connecté à l'alimentation par un système de connexion électrique et mécanique étudié pour construire des configurations personnalisées. Rosaces disponibles avec deux puissances : pour lampe de puissance inférieure à 70W et pour lampe de puissance inférieure à 190W. Il existe également des rosaces de classe III pour des installations avec alimentation à distance: version "surface" pour une installation sur béton, version "recessed" pour faux-plafond en placo-plâtre.

L'électronique intégrée dans la rosace permet d'utiliser des systèmes de variation : push, 1-10V, potentiomètre, DALI. Si aucun de ces systèmes n'est présent, il est possible, lors de l'installation, de régler le flux lumineux avec le système push inclus dans la rosace.

LONGUEUR DES CÂBLES: 2,5M (98.43")
MATÉRIAU: ALUMINIUM
FINITION: NOIR

SP Luminaria de suspensión con emisión de luz difusa. Cuerpo de aluminio extruido, curvado, trabajado con CN y lacado negro en polvo, difusor de silicona óptica de platino. Todos los elementos se pueden conectar a la alimentación a través de un sistema de conexión eléctrico y mecánico diseñado para permitir crear configuraciones personalizadas del producto.

Rosetones eléctricos disponibles con dos potencias: lámpara con potencia inferior a 70 W y lámpara con potencia inferior a 190 W. Disponibles también rosetones eléctricos de clase III para instalaciones con suministro eléctrico remoto: versión "de superficie" en el caso de instalaciones en cemento, versión "empotrada" para techos de yeso.

El sistema electrónico integrado en el rosetón eléctrico permite utilizar sistemas de atenuación de la luz: push, 1-10, potenciómetro, DALI. En caso de ausencia de estos sistemas, se puede configurar el flujo luminoso, durante la fase de instalación, con el sistema push incluido en el rosetón.

LONGITUD DE LOS CABLES: 2,5M (98.43")
MATERIAL: ALUMINIO
ACABADO: NEGRO

DE Hängebeleuchtungsgerät für diffuses Licht. Körper aus extrudiertem Aluminium, gebogen, mit CNC-Technik bearbeitet und mit schwarzem Pulverlack lackiert, Diffusor aus optischem Platin-Silikon. Jedes Element kann durch ein elektrisches und mechanisches System mit der Versorgung verbunden sein, welches studiert wurde, um personalisierte Konfigurationen des Produkts zu ermöglichen. Rosetten mit zwei Leistungen verfügbar: Lampe mit einer Leistung von max. 70W und Lampe mit einer Leistung von max. 190W. Auch Rosetten der Klasse III für Installationen mit externer Stromversorgung sind verfügbar: „Surface“-Version bei Installationen auf Beton, „Recessed“-Version für Rigips-Decken.

Mit der in der Rosette integrierten Elektronik ist die Verwendung von Dimmer-Systemen möglich: Push, 1-10, Potentiometer, DALI. Wenn diese Systeme nicht vorhanden sind, kann der Lichtfluss bei der Installation mit dem in der Rosette enthaltenen Push-System eingestellt werden.

KABELLÄNGE: 2,5M (98.43")
MATERIAL: ALUMINIUM
FINISH: SCHWARZ

Light elements

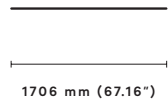

LINE
F0401030
flex strip led
29W 2700K CRI90 1480lm

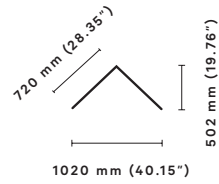

BROKEN LINE
F0405030
flex strip led
24W 2700K CRI90 1200lm

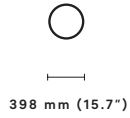

ROUND SMALL
F0406030
flex strip led
21W 2700K CRI90 1068lm



ROUND MEDIUM
F0407030
flex strip led
35W 2700K CRI90 1770lm

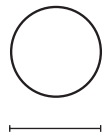

ROUND LARGE
F0408030
flex strip led
54W 2700K CRI90 2751lm

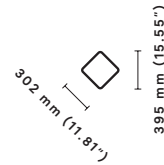

SQUARE SMALL
F0410030
flex strip led
20W 2700K CRI90 883lm

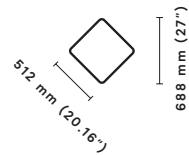

SQUARE LARGE
F0409030
flex strip led
34W 2700K CRI90 1657lm

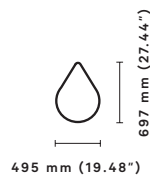

DROP UP
F0414030
flex strip led
32W 2700K CRI90 1530lm



DROP DOWN
F0413030
flex strip led
30W 2700K CRI90 1530lm

Calculate the wattage & pick up the ceiling rose



Choose your chandelier

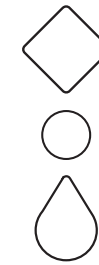

1 X ARRANGEMENTS
SQUARE LARGE



1 X ARRANGEMENTS
ROUND SMALL



1 X ARRANGEMENTS
DROP UP

Available roses

Cable length max 2500mm (98.43")



SMALL ROSE
F0416030
(USA: FU046130)
MAX 70W

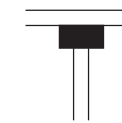

BIG ROSE
F0415030
(USA: FU041530)
MAX 190W

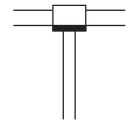

RECESSED ROSE
F0418030
(USA: FU041830)
MAX 190W

USED ELEMENTS

1 x ROUND LARGE
1 x ROUND SMALL
1 x LINE

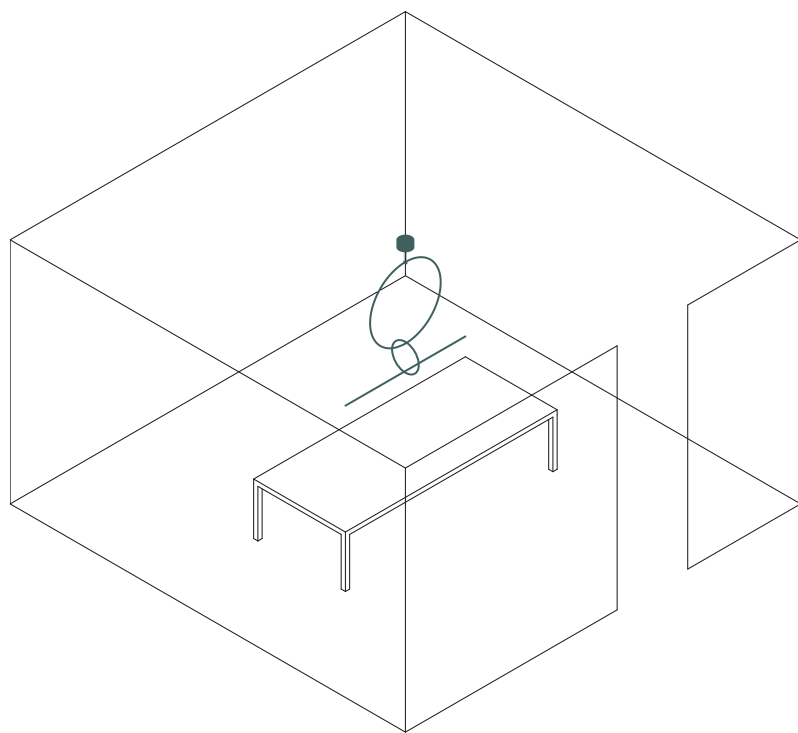

48

USED ELEMENTS

1 x ROUND SMALL
1 x LINE

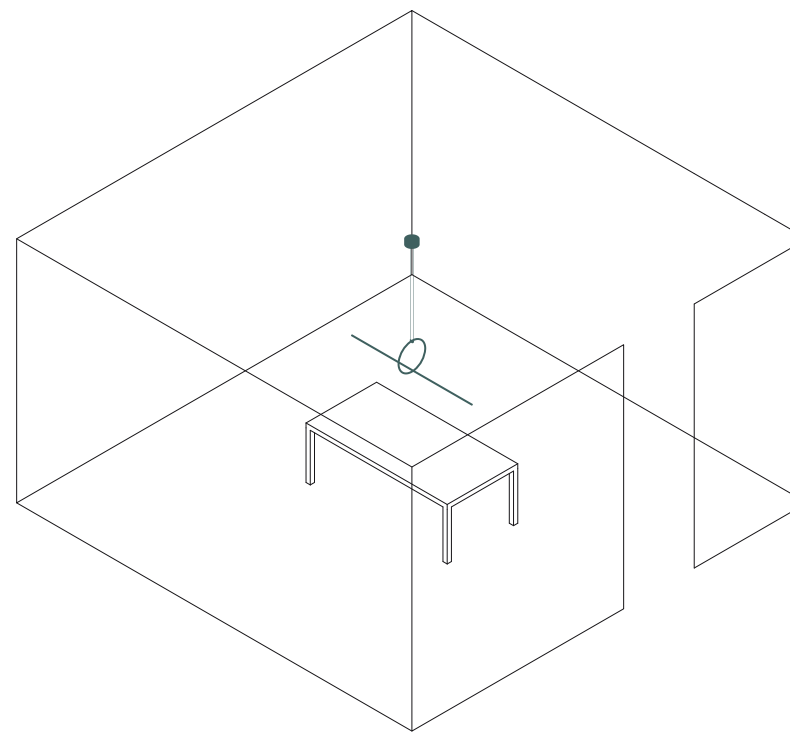

49

USED ELEMENTS

1 x SQUARE LARGE
1 x ROUND MEDIUM
1 x BROKEN LINE

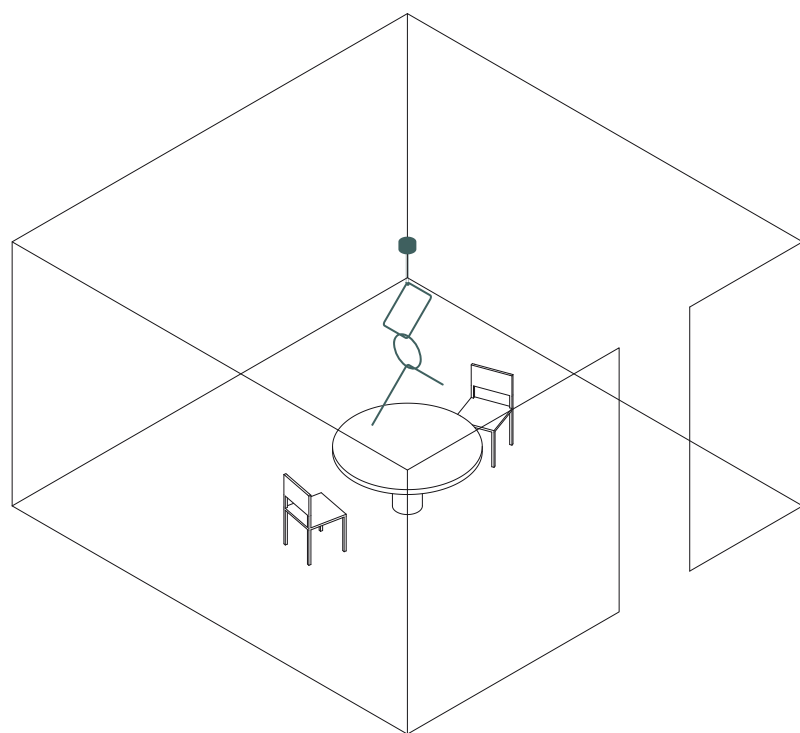

50

USED ELEMENTS

2 x SQUARE LARGE
2 x SQUARE SMALL

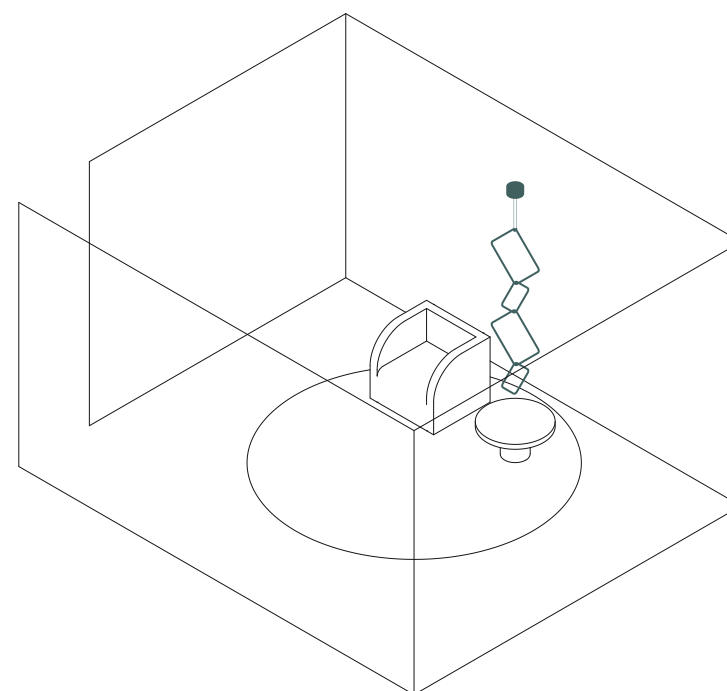

51

USED ELEMENTS

3 x DROP DOWN
3 x DROP UP

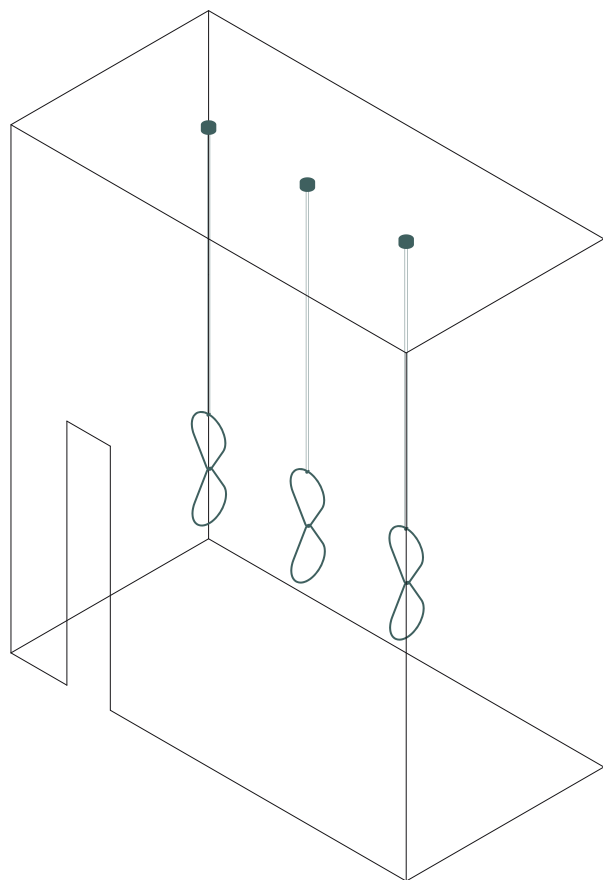

52

USED ELEMENTS

1 x LINE

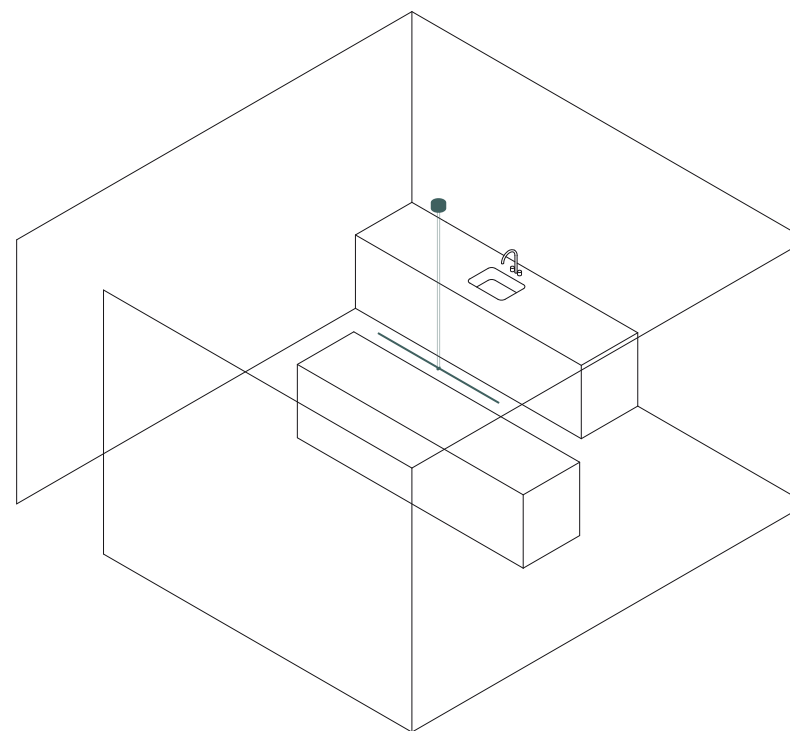

53

USED ELEMENTS

5 x DROP UP

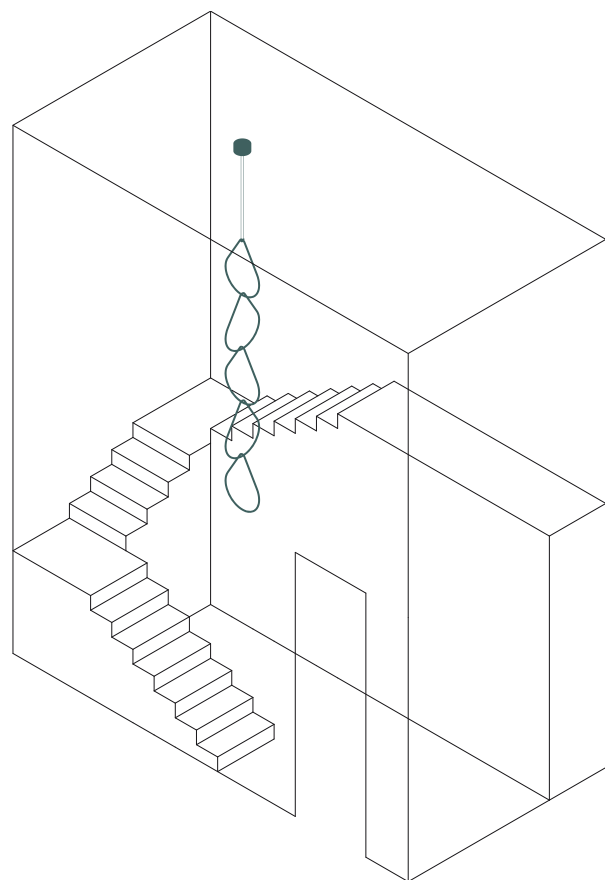

54

USED ELEMENTS

2 x SQUARE SMALL

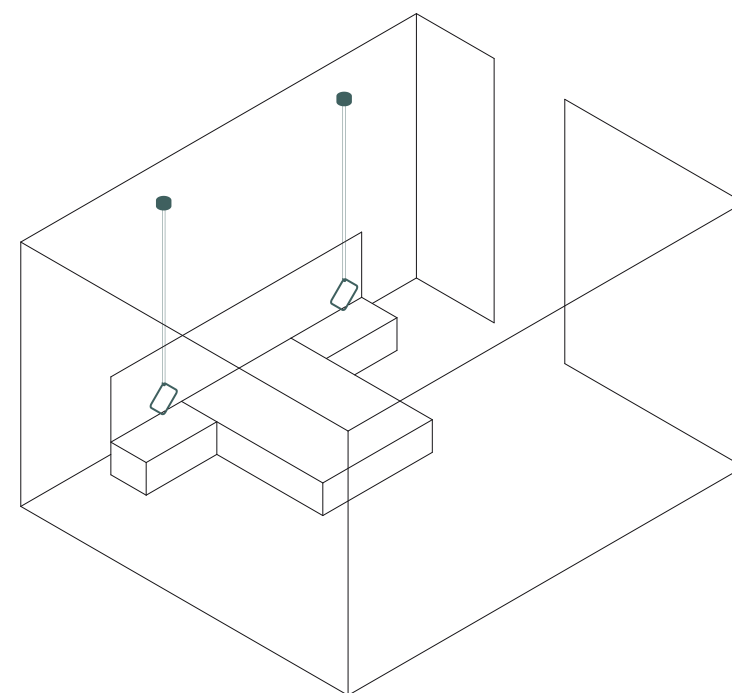

55

Custom made solutions

The Arrangements system offers a wide range of configurations, from the suspension of a few elements to the creation of major sculptural installations. Single chandeliers made up of one or more interconnected modules up to the maximum power output of the ceiling rose (70W or 190W) can be replicated and combined to create unique interplays of light and space.

IT Le possibilità di configurazione che offre il sistema Arrangements sono molteplici: dalla sospensione di pochi elementi alla creazione di grandi installazioni scultoree. Singoli chandelier, composti da uno o più moduli connessi l'uno all'altro fino al raggiungimento della potenza massima consentita dal proprio rosone (70W o 190W), possono essere replicati e combinati tra loro per dare vita a giochi unici tra luce e spazio.

FR Les possibilités de configuration offertes par le système Arrangements sont nombreuses: de la suspension de quelques éléments à la création de grandes installations sculpturales. Des lustres individuels, composés d'un ou plusieurs modules connectés les uns aux autres jusqu'à atteindre la puissance maximale autorisée par la rosace (70W ou 190W), peuvent être répliqués et combinés pour faire naître des jeux uniques entre la lumière et l'espace.

SP Las posibilidades de configuración que ofrece el sistema Arrangements son múltiples: desde la suspensión de unos pocos elementos a la creación de grandes instalaciones escultóricas. Se pueden duplicar o combinar entre sí lámparas individuales, compuestas por uno o más módulos conectados unos con otros, hasta alcanzar la potencia máxima permitida por el propio rosetón (70 W o 190 W), para dar vida a juegos únicos entre luz y espacio.

DE Das Arrangements-System bietet zahlreiche Konfigurationsmöglichkeiten: von der Aufhängung weniger Elemente bis hin zur Schaffung großartiger skulpturaler Installationen. Einzelne Leuchter, bestehend aus einem oder mehreren Modulen und untereinander bis zur Erreichung der erlaubten Höchstleistung der eigenen Rosette (70W oder 190W) verbunden, können wiederholt und miteinander kombiniert werden, um einzigartige Spiele zwischen Licht und Raum zu schaffen.

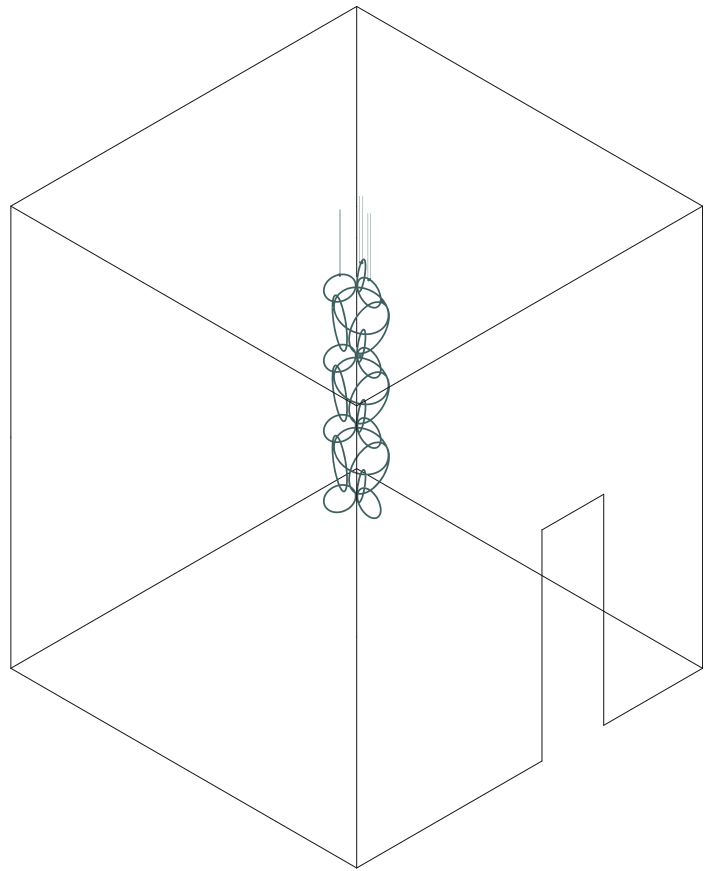

58

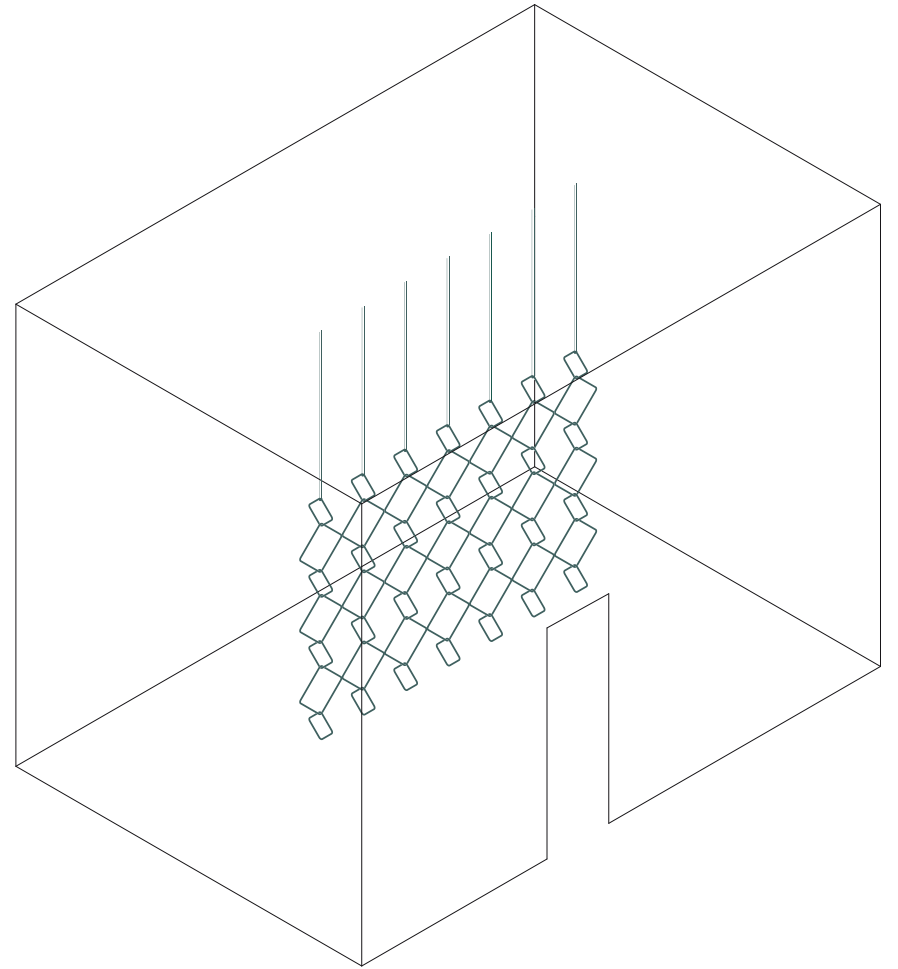

59

Credits

PHOTOGRAPHY Santi Caleca
ART DIRECTION Carina Frey & Stefanie Barth
GRAPHIC DESIGN Robin Pauwels
SET DESIGN Greta Cevenini

WWW.FLOS.COM

Flos reserves the right to introduce any change
to its own models without prior notice.

For images on page: 23-25-26-27-29-36-37-39
Copyright, FAI - Fondo per l'Ambiente Italiano - All rights reserved

FLOS

